



# Engineering Principles and Practices

for Retrofitting Flood-Prone Residential Structures  
(Third Edition)

FEMA P-259 / January 2012



FEMA

## About the Cover

After his Poquoson house suffered flood damage in November 2009, the owner decided to elevate the home to avoid future damages. The home was elevated an additional foot above the 1 foot freeboard required by the local ordinance. The finished floor is now 2 feet above the base flood elevation.



# Engineering Principles and Practices

for Retrofitting Flood-Prone Residential Structures  
(Third Edition)

*FEMA P-259 / January 2012*



**FEMA**

All illustrations in this document were created by FEMA or a FEMA contractor unless otherwise noted.

All photographs in this document are public domain or taken by FEMA or a FEMA contractor, unless otherwise noted.

Questions or comments on this manual are welcome and should be addressed to FEMA Building Science at <http://www.fema.gov/rebuild/buildingscience/index.shtm> or through the FEMA Building Science Helpline at 866-927-2104.

# Acknowledgments

The following people are involved with the update of FEMA P-259.  
The previous edition was produced in 2001.

## Third Edition Authors and Key Contributors

David Conrad, P.E., Atkins Global  
Omar Kapur, URS Group, Inc.  
Amit Mahadevia, URS Group, Inc.  
Desi Maldonado, P.E., Atkins Global  
Julia Moline, CFM, Dewberry  
Glenn Overcash, P.E., URS Group, Inc.  
Samantha Passman, URS Group, Inc.  
Manuel Perotin, P.E., CFM, Atkins Global  
Adam Reeder, P.E., CFM, Atkins Global  
Laura Seitz, CFM, URS Group, Inc.  
Adrienne Sheldon, P.E., CFM, URS Group, Inc.  
John Squerciati, P.E., CFM, Dewberry

## Third Edition Reviewers

Gene Barr, CFM  
Brooke Buchanan, P.E., CFM, FEMA Region VIII  
Jamin Buckingham, Wolfe House Movers  
William Coulbourne, P.E., Applied Technology Council  
Paul Gugenheim, P.E., Delta Structural Technology, Inc.  
Michael Hornick, FEMA Region IX  
John Ingargiola, CFM, FEMA Headquarters  
Christopher P. Jones, P.E., Durham, NC  
John Plisich, FEMA Region IV  
Ed Smith, FEMA Headquarters  
Jody Springer, FEMA Headquarters  
Paul Tertell, P.E., FEMA Headquarters  
Scott Tezak, P.E., TRC Solutions  
Gregory Wilson, CFM, FEMA Headquarters

## Third Edition Technical Editing, Layout, and Illustration

Deb Daly, Greenhorne & O'Mara  
Julie Liptak, Greenhorne & O'Mara  
Lee-Ann Lyons, URS Group, Inc.  
Billy Ruppert, URS Group, Inc.  
Devika Strother, URS Group, Inc.





# Contents

<b>Chapter 1. Introduction to Retrofitting</b> .....	1-1
1.1 Goals and Intended Users .....	1-1
1.2 Organization of the Manual .....	1-2
1.3 Methods of Retrofitting.....	1-4
1.3.1 Elevation .....	1-5
1.3.1.1 Elevation on Solid Perimeter Foundation Walls.....	1-6
1.3.1.2 Elevation on Open Foundation Systems .....	1-7
1.3.2 Relocation .....	1-11
1.3.3 Dry Floodproofing.....	1-12
1.3.4 Wet Floodproofing.....	1-14
1.3.5 Floodwalls and Levees .....	1-16
1.4 Considerations When Retrofitting.....	1-19
1.5 Retrofitting Process .....	1-19
1.5.1 Other Retrofitting Guides.....	1-21
<b>Chapter 2. Regulatory Requirements</b> .....	2-1
2.1 National Flood Insurance Program.....	2-2
2.1.1 Flood Hazard Information .....	2-3
2.1.1.1 Flood Insurance Rate Maps.....	2-3
2.1.1.2 Flood Insurance Studies .....	2-7
2.1.2 Floodplain Management Regulations.....	2-9
2.1.3 Insurance Program.....	2-10
2.1.4 NFIP Flood-Prone Building Performance Requirements.....	2-11
2.2 Community Regulations and the Permitting Process.....	2-12
2.3 National Model Building Codes.....	2-13
2.4 Consensus Standards .....	2-14
<b>Chapter 3. Parameters of Retrofitting</b> .....	3-1
3.1 Determination of Homeowner Preferences .....	3-2
3.1.1 The Initial Homeowner Meeting.....	3-2
3.1.2 Initial Site Visit .....	3-4
3.1.3 Aesthetic Concerns.....	3-5

3.1.4	Economic Considerations.....	3-6
3.1.5	Risk Considerations .....	3-9
3.1.6	Accessibility for Individuals with Special Needs .....	3-9
3.2	Community Regulations and Permitting.....	3-10
3.2.1	Local Codes .....	3-10
3.2.2	Building Systems/Code Upgrades .....	3-10
3.2.3	Off-Site Flooding Impacts.....	3-11
3.3	Technical Parameters.....	3-11
3.3.1	Flooding Characteristics.....	3-13
3.3.1.1	Flood Depth and Elevation .....	3-14
3.3.1.2	Flood Flow Velocity.....	3-15
3.3.1.3	Flood Frequency.....	3-16
3.3.1.4	Rates of Rise and Fall.....	3-16
3.3.1.5	Flood Duration .....	3-16
3.3.1.6	Debris Impact.....	3-16
3.3.2	Site Characteristics.....	3-17
3.3.2.1	Site Location .....	3-17
3.3.2.2	Vulnerability to Erosion.....	3-17
3.3.2.3	Soil Type .....	3-18
3.3.3	Building Characteristics .....	3-19
3.3.3.1	Substructure .....	3-20
3.3.3.2	Superstructure .....	3-20
3.3.3.3	Support Services .....	3-21
3.3.3.4	Building Construction.....	3-21
3.3.3.5	Building Condition .....	3-21
3.4	Balancing Historic Preservation With Flood Protection.....	3-25
3.5	Multiple Hazards.....	3-25
3.5.1	Earthquake Forces.....	3-26
3.5.2	Wind Forces .....	3-26
<b>Chapter 4. Determination of Hazards .....</b>		<b>4-1</b>
4.1	Analysis of Flood-Related Hazards .....	4-1
4.1.1	Determining Flood Elevations .....	4-3
4.1.1.1	Riverine Areas .....	4-3
4.1.1.2	Coastal Areas.....	4-6
4.1.2	Flood Forces and Loads.....	4-8
4.1.2.1	Flood Depth and Floodproofing Design Depth.....	4-8
4.1.2.2	Hydrostatic Forces.....	4-10
4.1.2.3	Lateral Hydrostatic Forces .....	4-11



4.1.2.4	Saturated Soil Forces .....	4-12
4.1.2.5	Combined Saturated Soil and Water Forces.....	4-13
4.1.2.6	Vertical Hydrostatic Forces.....	4-14
4.1.2.7	Hydrodynamic Forces .....	4-16
4.1.2.8	High Velocity Hydrodynamic Forces.....	4-20
4.1.2.9	Impact Loads.....	4-21
4.1.2.10	Riverine Erosion .....	4-24
4.1.3	Site Drainage .....	4-25
4.1.4	Movable Bed Streams.....	4-30
4.1.5	Analysis of Non-Flood-Related Hazards.....	4-30
4.1.6	Wind Forces.....	4-31
4.1.7	Seismic Forces .....	4-35
4.1.8	Combining Forces.....	4-36
4.1.9	Protection of the Structure .....	4-36
4.1.10	Protection of Non-Structural Building Components and Building Contents .....	4-37
4.1.11	Land Subsidence .....	4-37
4.2	Geotechnical Considerations .....	4-38
4.2.1	Allowable Bearing Capacity .....	4-40
4.2.2	Scour Potential.....	4-42
4.2.2.1	Frost Zone Considerations.....	4-48
4.2.2.2	Permeability .....	4-48
4.2.2.3	Shrink-Swell Potential .....	4-50
<b>Chapter 5. General Design Practices .....</b>		<b>5-1</b>
5.1	Field Investigation .....	5-3
5.1.1	Local Building Requirements.....	5-3
5.1.2	Surveys.....	5-3
5.1.3	Structure Survey .....	5-3
5.1.4	Topographic Survey .....	5-4
5.1.5	Site Utilities Survey.....	5-5
5.1.6	Hazard Determinations.....	5-6
5.1.7	Documentation of Existing Building Systems .....	5-6
5.1.8	Homeowner Preferences.....	5-10
5.1.9	Homeowner Coordination .....	5-10
5.1.10	Maintenance Programs and Emergency Action Plans.....	5-10
5.2	Analysis of Existing Structure.....	5-11
5.2.1	Structural Reconnaissance .....	5-11
5.2.2	Footings and Foundation Systems.....	5-12
5.2.3	Bearing Capacity of Footings .....	5-13
5.2.4	Bearing Capacity of Foundation Walls .....	5-15

5.2.5	Lateral Loads.....	5-15
5.2.6	Vertical Loads .....	5-17
5.2.7	Dead Loads.....	5-17
5.2.8	Live Loads.....	5-19
5.2.9	Roof Snow Loads .....	5-20
5.2.10	Calculation of Vertical, Dead, Live, and Snow Loads.....	5-20
5.2.11	Capacity versus Loading.....	5-24
5.2.12	Load Combination Scenarios .....	5-24
5.2.13	Strength Design Method.....	5-25
5.2.14	Allowable Stress Method.....	5-27
<b>Chapter 5D. Dry Floodproofing .....</b>		<b>5D-1</b>
5D.1	Emergency Operations Plan.....	5D-3
5D.2	Inspection and Maintenance Plan.....	5D-3
5D.3	Sealants and Shields.....	5D-3
5D.4	Field Investigation .....	5D-9
5D.5	Confirm Structure is Designed to Accommodate Dry Floodproofing Measures.....	5D-10
5D.6	Selection and Design of Sealant Systems.....	5D-16
5D.6.1	Coatings .....	5D-17
5D.6.2	Wrapped Systems.....	5D-17
5D.6.3	Brick Veneer Systems .....	5D-20
5D.7	Selection and Design of Shield Systems .....	5D-22
5D.7.1	Plate Shields.....	5D-22
5D.8	Construction Considerations for Sealants and Shields .....	5D-25
5D.9	Drainage Collection Systems .....	5D-25
5D.9.1	French Drains.....	5D-28
5D.9.2	Exterior Underdrain Systems .....	5D-28
5D.9.3	Interior Drain System .....	5D-29
5D.9.4	Types of Sump Pumps.....	5D-31
5D.9.5	Infiltration versus Inundation .....	5D-32
5D.9.6	Coordination with Other Floodproofing Methods .....	5D-33
5D.9.7	Field Investigation .....	5D-33
5D.9.8	Design .....	5D-35
5D.10	Backflow Valves .....	5D-39
5D.10.1	Field Investigation .....	5D-40
5D.10.2	Design .....	5D-41
5D.11	Emergency Power .....	5D-43
5D.11.1	Field Investigation .....	5D-43
5D.11.2	Design .....	5D-44
5D.11.3	Construction .....	5D-50

5D.12 Non-Residential Construction ..... 5D-50

    5D.12.1 Permanent Closure of Openings ..... 5D-50

    5D.12.2 Watertight Core Areas ..... 5D-51

    5D.12.3 Enhanced Flood Shields ..... 5D-52

    5D.12.4 Moveable Floodwalls ..... 5D-52

    5D.12.5 Pressure Relief Systems ..... 5D-54

**Chapter 5E. Elevation** ..... 5E-1

5E.1 Types of Residential Structures that Can Be Elevated ..... 5E-2

    5E.1.1 Houses Over a Crawlspace ..... 5E-2

    5E.1.2 Houses Over Basements ..... 5E-8

        5E.1.2.1 Design of Openings in Foundation Walls for Intentional Flooding  
of Enclosed Areas Below the DFE ..... 5E-11

    5E.1.3 Houses on Piers, Columns, or Piles ..... 5E-13

    5E.1.4 Slab-on-Grade Houses ..... 5E-13

        5E.1.4.1 Elevating a Slab-on-Grade Wood-Frame House ..... 5E-14

        5E.1.4.2 Elevating a Slab-on-Grade Masonry House ..... 5E-19

    5E.1.5 Heavy Building Materials/Complex Design ..... 5E-19

5E.2 Field Investigation Concerns..... 5E-22

    5E.2.1 Property Inspection and Existing Data Review ..... 5E-22

    5E.2.2 Code Search..... 5E-22

5E.3 Design ..... 5E-24

5E.4 Construction Considerations ..... 5E-30

    5E.4.1 Slab-on-Grade House, Not Raising Slab with House ..... 5E-30

    5E.4.2 Slab-on-Grade House, Raising Slab ..... 5E-31

    5E.4.3 House Over Crawlspace/Basement..... 5E-31

    5E.4.4 House on Piers, Columns, or Piles ..... 5E-32

**Chapter 5F. Floodwalls and Levees** ..... 5F-1

5F.1 Floodwalls ..... 5F-2

    5F.1.1 Types of Floodwalls..... 5F-2

        5F.1.1.1 Gravity Floodwall..... 5F-2

        5F.1.1.2 Cantilever Floodwall ..... 5F-4

        5F.1.1.3 Buttressed Floodwall ..... 5F-6

        5F.1.1.4 Counterfort Floodwall..... 5F-7

    5F.1.2 Field Investigation for Floodwalls..... 5F-8

    5F.1.3 Floodwall Design ..... 5F-10

        5F.1.3.1 Floodwall Design (Selection and Sizing)..... 5F-10

        5F.1.3.2 Floodwall Design (Simplified Approach) ..... 5F-29

    5F.1.4 Floodwall Appurtenances..... 5F-31



5F.1.4.1	Floodwall Closures .....	5F-31
5F.1.4.2	Drainage Systems .....	5F-39
5F.1.5	Floodwall Seepage and Leakage .....	5F-42
5F.1.5.1	Seepage Through the Floodwall.....	5F-42
5F.1.5.2	Seepage Under the Floodwall .....	5F-42
5F.1.5.3	Leakage Between the Floodwall and Residence .....	5F-43
5F.1.6	Floodwall Architectural Details .....	5F-43
5F.1.7	Floodwall Construction .....	5F-47
5F.2	Levees.....	5F-48
5F.2.1	Levee Field Investigation.....	5F-48
5F.2.2	Levee Design.....	5F-49
5F.2.2.1	Standard Levee Design Criteria .....	5F-49
5F.2.2.2	Initial Levee Design Phases .....	5F-51
5F.2.3	Levee Seepage Concerns.....	5F-51
5F.2.3.1	Scouring/Levee Slope Protection .....	5F-52
5F.2.3.2	Interior Levee Drainage.....	5F-53
5F.2.3.3	Levee Maintenance.....	5F-54
5F.2.3.4	Levee Cost.....	5F-54
5F.2.4	Levee Construction.....	5F-56
5F.2.4.1	Levee Soil Suitability.....	5F-56
5F.2.4.2	Levee Compaction Requirements .....	5F-56
5F.2.4.3	Levee Settlement Allowance .....	5F-56
5F.2.4.4	Levee Borrow Area Restrictions.....	5F-56
5F.2.4.5	Access Across Levee.....	5F-57
<b>Chapter 5R. Relocation</b>	.....	<b>5R-1</b>
5R.1	Step 1: Select the House Moving Contractor .....	5R-2
5R.2	Step 2: Analyze the Existing Site and Structure .....	5R-4
5R.3	Step 3: Select, Analyze, and Design the New Site .....	5R-5
5R.4	Step 4: Prepare the Existing Site .....	5R-6
5R.5	Step 5: Analyze and Prepare the Moving Route .....	5R-6
5R.6	Step 6: Prepare the Structure .....	5R-7
5R.7	Step 7: Prepare the New Site.....	5R-10
5R.8	Step 8: Move the Structure .....	5R-11
5R.9	Step 9: Restore the Old Site.....	5R-13
<b>Chapter 5W. Wet Floodproofing</b>	.....	<b>5W-1</b>
5W.1	Protection of the Structure.....	5W-2
5W.1.1	Foundations .....	5W-3

5W.1.2	Cavity Walls .....	5W-3
5W.1.3	Solid Walls .....	5W-4
5W.2	Use of Flood-Resistant Materials .....	5W-4
5W.3	Building Operations and Maintenance Procedures and Emergency Preparedness Plans.....	5W-5
5W.3.1	Flood Warning System .....	5W-5
5W.3.2	Inspection and Maintenance Plan .....	5W-5
5W.3.3	Emergency Operations Plan .....	5W-5
5W.3.4	Protection of Utility Systems .....	5W-6
5W.4	Elevation .....	5W-7
5W.5	In-Place Protection .....	5W-7
5W.6	Field Investigation .....	5W-8
5W.7	Design Overview .....	5W-11
5W.8	Electrical Systems .....	5W-11
5W.9	Heating, Ventilating, and Air Conditioning Systems .....	5W-13
5W.10	Fuel Supply/Storage Systems .....	5W-13
5W.11	Water Systems.....	5W-15
5W.12	Sewer Systems.....	5W-15
5W.13	Calculation of Buoyancy Forces.....	5W-16
5W.14	Construction/Implementation .....	5W-18
<b>Chapter 6</b>	<b>Case Studies .....</b>	<b>6-1</b>
6.1	Case Study #1: Residential Retrofit in Riverine Floodplain Using Elevation or Relocation .....	6-1
6.1.1	Description of Property .....	6-1
6.1.2	Structure Information .....	6-2
6.1.3	Retrofit Options Selection.....	6-4
6.1.4	Load Calculations .....	6-9
6.1.5	Supporting Documentation .....	6-15
6.1.6	Real World Examples .....	6-23
6.2	Case Study #2: Residential Retrofit in Coastal A Zone Using Elevation or Acquisition.....	6-24
6.2.1	Description of Property .....	6-24
6.2.2	Structure Information .....	6-24
6.2.3	Retrofit Options Selection.....	6-26
6.2.4	Load Calculations .....	6-30
6.2.5	Supporting Documentation .....	6-33
6.2.6	Real World Examples .....	6-39
6.3	Case Study #3: Residential Retrofit Outside of the Floodplain Using Dry or Wet Floodproofing.....	6-40
6.3.1	Description of Property .....	6-40
6.3.2	Structure Information .....	6-40
6.3.3	Retrofit Options Selection.....	6-43

6.3.4	Load Calculations .....	6-46
6.3.5	Supporting Documentation .....	6-51
6.3.6	Real World Examples .....	6-57
6.4	Case Study #4: Residential Retrofit Outside of the Floodplain Using Floodwalls or Levees .....	6-59
6.4.1	Description of Property .....	6-59
6.4.2	Structure Information .....	6-59
6.4.3	Retrofit Options Selection .....	6-60
6.4.4	Load Calculations .....	6-64
6.4.5	Drainage Requirements .....	6-64
6.4.6	Supporting Documentation .....	6-66
6.4.7	Real World Examples .....	6-70

## Appendices

Appendix A. Sources of FEMA Funding .....	A-1
Appendix B. Understanding the FEMA Benefit-Cost Analysis Process .....	B-1
Appendix C. Sample Design Calculations .....	C-1
Appendix D. Alluvial Fan Flooding .....	D-1
Appendix E. References .....	E-1
Appendix F. Other Resources .....	F-1
Appendix G. Summary of NFIP Requirements and Best Practices .....	G-1
Appendix H. Acronyms .....	H-1

## List of Figures

### Chapter 1

Figure 1-1.	Elevation on solid perimeter foundation walls .....	1-6
Figure 1-2.	Elevation of existing residence on extended foundation walls .....	1-7
Figure 1-3.	Elevation on piers .....	1-8
Figure 1-4.	Elevation on posts or columns .....	1-8
Figure 1-5.	Elevation on piles .....	1-9
Figure 1-6.	Structure elevated on piles .....	1-10
Figure 1-7.	Structure placed on a wheeled vehicle for relocation to a new site .....	1-11
Figure 1-8.	Structure to be relocated .....	1-12
Figure 1-9.	Dry floodproofed structure .....	1-13



Figure 1-10. Wet floodproofed structure ..... 1-15

Figure 1-11. Structure protected by floodwall and levee ..... 1-17

Figure 1-12. Home protected by a levee..... 1-17

Figure 1-13. Primary steps in retrofitting process .....1-20

**Chapter 2**

Figure 2-1. Typical DFIRM for riverine flooding ..... 2-4

Figure 2-2. Typical DFIRM for coastal flooding showing the Limit of Moderate Wave Action (LiMWA)..... 2-5

Figure 2-3. Typical riverine floodplain cross section ..... 2-7

Figure 2-4. Wave height transect showing LiMWA, MoWA, and MiWA ..... 2-8

**Chapter 3**

Figure 3-1. Preliminary Floodproofing/Retrofitting Preference Matrix..... 3-3

Figure 3-2. Survey to identify the low point of floodwater entry into a typical residential structure..... 3-5

Figure 3-3. Preliminary Cost Estimating Worksheet ..... 3-8

Figure 3-4. Retrofitting Screening Matrix ..... 3-12

Figure 3-5. Instructions for Retrofitting Screening Matrix ..... 3-13

Figure 3-6. Measuring mud lines or high water marks to establish flood depth .....3-14

Figure 3-7. Hydrostatic and buoyancy forces.....3-15

Figure 3-8. Large, fast-moving waves combined with erosion and scour to destroy this Gulf of Mexico home during Hurricane Opal.....3-18

Figure 3-9. Lateral and buoyancy forces resulting from saturated soil .....3-19

Figure 3-10. Preliminary Building Condition Worksheet ..... 3-23

**Chapter 4**

Figure 4-1. Flood-related hazards ..... 4-2

Figure 4-2. House and stream location on the DFIRM ..... 4-4

Figure 4-3. House location on flood profile for Big Branch (Stream 21)..... 4-5

## CONTENTS

---

Figure 4-4.	Coastal DFIRM showing house location and flood elevation .....	4-7
Figure 4-5.	Flood depth and design depth .....	4-10
Figure 4-6.	Hydrostatic forces .....	4-11
Figure 4-7.	Diagram of hydrostatic forces.....	4-11
Figure 4-8.	Combination soil/water hydrostatic and buoyancy forces .....	4-13
Figure 4-9.	Hydrostatic Force Computation Worksheet .....	4-15
Figure 4-10.	Hydrodynamic and impact forces .....	4-16
Figure 4-11.	Equivalent Hydrostatic Force Computation Worksheet.....	4-19
Figure 4-12.	Hydrodynamic Force (High Velocity) Computation Worksheet.....	4-21
Figure 4-13.	Impact Force Computation Worksheet.....	4-24
Figure 4-14.	Rectangular area enclosed by a floodwall or levee.....	4-26
Figure 4-15.	Rectangular area partially enclosed by a floodwall or levee.....	4-27
Figure 4-16.	Interior Drainage Computation Worksheet.....	4-29
Figure 4-17.	Non-flood-related natural hazards.....	4-31
Figure 4-18.	Wind-induced pressures on a building .....	4-32
Figure 4-19A.	Basic wind speed map .....	4-33
Figure 4-19B.	Regions where wind design is required .....	4-34
Figure 4-20.	Seismic design process.....	4-35
Figure 4-21.	Seismic design causes and effects.....	4-36
Figure 4-22.	Geotechnical Considerations Decision Matrix .....	4-39
Figure 4-23.	Localized scour at piers, posts, and piles.....	4-42
Figure 4-24.	Scour action on a ground level building .....	4-43
Figure 4-25.	Process for estimating potential scour depth.....	4-44
Figure 4-26.	Flow Angle of Attack .....	4-46
Figure 4-27.	Terminating stratum .....	4-47
Figure 4-28.	Additional embedment for foundation member .....	4-47

**Chapter 5**

Figure 5-1. Design process ..... 5-2

Figure 5-2. Mechanical, Electrical, Plumbing, and Related Building Systems Data Sheet..... 5-7

Figure 5-3. Structural Reconnaissance Worksheet ..... 5-12

Figure 5-4. Foundation system loading ..... 5-13

Figure 5-5. Building Weight Estimating Worksheet ..... 5-19

Figure 5-6. Column tributary area ..... 5-22

Figure 5-7. Wall/girder tributary area..... 5-22

**Chapter 5D**

Figure 5D-1. Process of selection and design for dry floodproofing ..... 5D-2

Figure 5D-2. A way to seal an existing brick-faced wall is to add an additional layer of brick with a seal in between ..... 5D-4

Figure 5D-3. A wrapped house sealing system can be used to protect against fast transient low-level flooding..... 5D-5

Figure 5D-4. A shield hinged at its bottom could prevent low-level flooding from entering a garage or driveway..... 5D-6

Figure 5D-5. A door opening may be closed using a variety of materials for shields..... 5D-7

Figure 5D-6. A shield can help prevent low-level flooding from entering through a doorway..... 5D-7

Figure 5D-7. Where a window is exposed to a flood, bricking up the opening could eliminate the hazard. .... 5D-8

Figure 5D-8. Dry floodproofed homes should have an effective drainage system around footings and slabs to reduce water pressure on foundation walls and basements ..... 5D-8

Figure 5D-9. Illustration of hydrostatic force.....5D-10

Figure 5D-10. Existing building structural evaluations .....5D-11

Figure 5D-11. This house located in the SFHA was displaced from its foundation into the roadway adjacent to it..... 5D-12

Figure 5D-12. The photo on the right shows the house’s original location ..... 5D-12

Figure 5D-13. Typical design strip for reinforced masonry ..... 5D-13

## CONTENTS

---

Figure 5D-14.	This house’s foundation walls were not able to withstand the forces applied during or after the flood.....	5D-13
Figure 5D-15.	Typical slab uplift failure.....	5D-14
Figure 5D-16.	This house’s foundation was rebuilt after collapse from saturated soil forces after a flood.....	5D-16
Figure 5D-17.	Selection of sealants/coatings.....	5D-17
Figure 5D-18.	Selection and design of wrapped sealant systems .....	5D-18
Figure 5D-19.	Plan view of wall section .....	5D-19
Figure 5D-20.	Selection/design of a brick veneer sealant system .....	5D-21
Figure 5D-21.	Selection/design of plate shields.....	5D-23
Figure 5D-22.	Typical residential masonry block wall construction.....	5D-26
Figure 5D-23.	Common faults contributing to seepage into basements .....	5D-27
Figure 5D-24.	Typical French drain system.....	5D-28
Figure 5D-25.	Typical exterior underdrain system with sump pump showing two alternative configurations in the side view .....	5D-29
Figure 5D-26.	Details of a combination underdrain and foundation waterproofing system .....	5D-30
Figure 5D-27.	Typical interior drain systems.....	5D-30
Figure 5D-28.	Types of sump pumps .....	5D-31
Figure 5D-29.	Foundation wall failure due to pumping out basement while ground was still saturated with water .....	5D-33
Figure 5D-30.	Sump Pump Field Investigation Worksheet.....	5D-34
Figure 5D-31.	Sump pump design process .....	5D-35
Figure 5D-32.	Typical sump detail.....	5D-36
Figure 5D-33.	Backflow valve .....	5D-40
Figure 5D-34.	Backflow valve selection .....	5D-40
Figure 5D-35.	Backflow Valve Field Investigation Worksheet.....	5D-41
Figure 5D-36.	Emergency power design process.....	5D-44
Figure 5D-37.	Permanent closure of an opening to prevent floodwaters from entering the building .....	5D-51

Figure 5D-38. A watertight door used to protect mechanical rooms for a hospital subject to floodwaters..... 5D-52

Figure 5D-39. Flood shields that can be raised and lowered to protect a hospital mechanical room from floodwaters..... 5D-53

Figure 5D-40. Moveable floodwalls in storage that can be deployed by filling baffles with water..... 5D-53

Figure 5D-41. The location to which the moveable floodwalls shown in Figure 5D-40 would be deployed ..... 5D-54

## Chapter 5E

Figure 5E-1. Existing wood-frame house on crawlspace foundation to be elevated with extended walls and piers..... 5E-3

Figure 5E-2. Step 1 of elevating an existing wood-frame house on extended foundation walls and piers..... 5E-3

Figure 5E-3. Step 2 of elevating an existing wood-frame house on extended foundation walls and piers..... 5E-4

Figure 5E-4. Step 3 of elevating an existing wood-frame house on extended foundation walls and piers..... 5E-4

Figure 5E-5. Cross-section of elevated wood-frame house on extended piers and crawlspace walls.... 5E-5

Figure 5E-6. Step 1 of elevating an existing wood frame house on new or extended pier foundations ..... 5E-6

Figure 5E-7. Step 3 of elevating an existing wood-frame house on new or extended pier foundation ..... 5E-6

Figure 5E-8. Cross-section of elevated wood-frame house on new or extended pier foundation..... 5E-7

Figure 5E-9. Elevated wood-frame house with new masonry-enclosed area on top of an abandoned and filled-in basement ..... 5E-8

Figure 5E-10. Cross-section of elevated wood-frame house with extended masonry-enclosed area on top of an abandoned and filled-in basement ..... 5E-9

Figure 5E-11. Cross-section of elevated wood-frame house on new reinforced piers on top of the existing filled-in basement ..... 5E-10

Figure 5E-12. Elevated wood-frame house set on new reinforced piers on top of the existing filled-in basement ..... 5E-11

Figure 5E-13. Typical opening for solid foundation wall ..... 5E-11

Figure 5E-14. A house where flood openings have been covered by insulation and drywall ..... 5E-12

## CONTENTS

---

Figure 5E-15.	NFIP-compliant house built on solid foundation walls with attached garage.....	5E-13
Figure 5E-16.	Existing wood-frame house with slab and stem-wall foundation .....	5E-14
Figure 5E-17.	Step 1 of elevating an existing wood-frame house without the slab using a new first floor constructed of wood trusses .....	5E-15
Figure 5E-18.	Step 2 of elevating an existing wood-frame house without the slab using a new first floor constructed of wood trusses .....	5E-16
Figure 5E-19.	Step 3 of elevating an existing wood-frame house without the slab and with extended stem wall using a new first floor constructed of wood trusses .....	5E-16
Figure 5E-20.	Cross-section of elevated wood-frame house (slab not raised) with extended stem-wall foundation and newly installed wood truss floor .....	5E-17
Figure 5E-21.	Step 1 of elevating an existing wood-frame house with stem wall foundation and the slab intact.....	5E-18
Figure 5E-22.	Step 3 of elevating an existing wood-frame house with stem wall foundation and the slab intact.....	5E-19
Figure 5E-23.	Cross-section of elevated wood-frame house with stem wall foundation and the slab intact.....	5E-20
Figure 5E-24.	Design process for an elevated house on foundation walls.....	5E-21
Figure 5E-25.	Elevation Field Investigation Worksheet.....	5E-23

## Chapter 5F

Figure 5F-1.	Typical residential floodwall.....	5F-3
Figure 5F-2.	Typical residential floodwall.....	5F-3
Figure 5F-3.	Gravity and cantilever floodwalls .....	5F-4
Figure 5F-4.	Buttress and counterfort floodwalls .....	5F-4
Figure 5F-5.	Stability of gravity floodwalls .....	5F-5
Figure 5F-6.	Concrete cantilever floodwall reinforcement.....	5F-5
Figure 5F-7.	Stability of cantilever floodwalls.....	5F-6
Figure 5F-8.	Typical section of a brick-faced concrete floodwall .....	5F-7
Figure 5F-9.	Seepage underneath a floodwall.....	5F-9
Figure 5F-10.	Reducing phreatic surface influence by increasing distance from foundation to floodwall and adding foundation drain .....	5F-9

Figure 5F-11.	Floodwall design process .....	5F-11
Figure 5F-12.	Failure by sliding.....	5F-12
Figure 5F-13.	Failure by overturning.....	5F-12
Figure 5F-14.	Failure due to excessive soil pressure.....	5F-13
Figure 5F-15.	Forces acting on a floodwall .....	5F-14
Figure 5F-16.	Typical floodwall reinforcing steel configuration .....	5F-29
Figure 5F-17.	Typical floodwall closures.....	5F-32
Figure 5F-18.	Closure variables .....	5F-32
Figure 5F-19.	Sample patio drainage to an outlet .....	5F-40
Figure 5F-20.	Sample patio drainage to a sump.....	5F-40
Figure 5F-21.	Typical gravity floor drain .....	5F-41
Figure 5F-22.	Typical floodwall with check valve .....	5F-41
Figure 5F-23.	Waterstop.....	5F-42
Figure 5F-24.	Floodwall to house connection.....	5F-43
Figure 5F-25.	Floodwall supporting columns .....	5F-44
Figure 5F-26.	Typical step detail .....	5F-45
Figure 5F-27.	Floodwall Inspection Worksheet .....	5F-47
Figure 5F-28.	Typical residential levee.....	5F-50
Figure 5F-29.	Drainage toe details .....	5F-52
Figure 5F-30.	Drain pipe extending through levee .....	5F-53
Figure 5F-31.	Interior storage area.....	5F-54
Figure 5F-32.	Levee Cost Estimating Worksheet.....	5F-55
Figure 5F-33.	Compacted lifts.....	5F-56
Figure 5F-34.	Access over the levee.....	5F-57

## Chapter 5R

Figure 5R-1.	House relocation .....	5R-1
--------------	------------------------	------

## CONTENTS

---

Figure 5R-2.	Relocation process.....	5R-2
Figure 5R-3.	Relocation contractor selection checklist .....	5R-3
Figure 5R-4.	Clearing pathways beneath the structure for lifting supports.....	5R-6
Figure 5R-5.	Pathways for lifting beams .....	5R-8
Figure 5R-6.	Beams supported by cribbing are placed at critical lift points .....	5R-8
Figure 5R-7.	Hydraulic jacks installed to lift structure from foundation .....	5R-9
Figure 5R-8.	Structure is separated from its foundation .....	5R-9
Figure 5R-9.	Foundation preparation at new site.....	5R-10
Figure 5R-10.	New foundation wall construction begins .....	5R-11
Figure 5R-11.	Trailer wheel sets are placed beneath the lifting beams.....	5R-11
Figure 5R-12.	Trailer is used to pull the house to the street .....	5R-12
Figure 5R-13.	House is lowered and connected to the foundation after foundation walls are completed.....	5R-12

## Chapter 5W

Figure 5W-1.	Elevated air conditioning compressor .....	5W-6
Figure 5W-2.	Flood enclosure protects basement utilities from shallow flooding.....	5W-8
Figure 5W-3.	Flood-Resistant Retrofitting Field Investigation Worksheet.....	5W-9
Figure 5W-4.	Wet floodproofing of utilities design process .....	5W-11
Figure 5W-5.	An improperly anchored tank; tethered only by a supply line .....	5W-14
Figure 5W-6.	Fuel tank anchored from two sides.....	5W-14
Figure 5W-7.	Backflow valve – a check valve and gate valve with an effluent pump bypass.....	5W-16

## Chapter 6

Figure 6-1.	The Truman house.....	6-3
Figure 6-2.	Preliminary Floodproofing/Retrofitting Preference Matrix for the Truman house.....	6-5
Figure 6-3.	The Truman house after elevation, including extended foundation walls and flood vents .....	6-7
Figure 6-4.	Hydrostatic Force Computation Worksheet for the elevated Truman house .....	6-8



Figure 6-5.	Equivalent Hydrostatic Force Computation Worksheet for the Truman house.....	6-9
Figure 6-6.	Impact Force Computation Worksheet for the Truman house.....	6-10
Figure 6-7.	Moment diagram for the Truman house .....	6-14
Figure 6-8.	Cross section of displaced soil and footer.....	6-14
Figure 6-9.	Topographic map showing the location of the Truman plot .....	6-16
Figure 6-10.	FIRM showing the location of the Truman plot.....	6-17
Figure 6-11.	FIS Excerpt: Discharge table for the Truman house .....	6-18
Figure 6-12.	FIS excerpt: Flood profile for the Truman house .....	6-19
Figure 6-13.	Elevation certificate excerpt for the Truman house.....	6-20
Figure 6-14.	Truman house tax card .....	6-21
Figure 6-15.	Sample BCA report excerpt for the Truman house elevation and relocation projects ....	6-22
Figure 6-16.	Relocation of an existing building to another location.....	6-23
Figure 6-17.	Elevation of an existing home above the BFE.....	6-23
Figure 6-18.	The Chester house, before mitigation .....	6-24
Figure 6-19.	Preliminary Floodproofing/Retrofitting Preference Matrix for the Chester house.....	6-27
Figure 6-20.	The Chester house, after mitigation.....	6-29
Figure 6-21.	Timber pile plan for the elevated Chester house .....	6-29
Figure 6-22.	Impact Force Computation Worksheet for the Chester house.....	6-30
Figure 6-23.	Topographic map for the Chester house .....	6-33
Figure 6-24.	DFIRM excerpt and FIS excerpt: Summary of stillwater elevations for the Chester house.....	6-34
Figure 6-25.	Elevation certificate excerpt for the Chester house.....	6-35
Figure 6-26.	Tax card for the Chester house .....	6-36
Figure 6-27.	Sample BCA Report excerpt for the Chester house elevation and acquisition .....	6-38
Figure 6-28.	House elevated on timber piles.....	6-39
Figure 6-29.	Elevation on timber piles.....	6-39
Figure 6-30.	Plan drawing for the Borges house .....	6-40

## CONTENTS

---

Figure 6-31.	Elevation drawings from the front, back, and side of the Borges house.....	6-41
Figure 6-32.	Preliminary Floodproofing/Retrofitting Preference Matrix for the Borges house .....	6-44
Figure 6-33.	Hydrostatic Force Computation Worksheet for the Borges house.....	6-47
Figure 6-34.	Moment diagram for the Borges house, slab only .....	6-51
Figure 6-35.	Topographic map showing the location of the Borges house.....	6-52
Figure 6-36.	FIRMette for the Borges house .....	6-53
Figure 6-37.	Elevation certificate excerpt for the Borges house .....	6-54
Figure 6-38.	Tax card for the Borges house .....	6-55
Figure 6-39.	Sample BCA report excerpt for dry and wet floodproofing of the Borges house.....	6-56
Figure 6-40.	Example of a flood shield over a door .....	6-57
Figure 6-41.	Example of a flood shield over a door .....	6-57
Figure 6-42.	Example of flood vents .....	6-58
Figure 6-43.	Example of flood vents .....	6-58
Figure 6-44.	Valley house .....	6-60
Figure 6-45.	Preliminary Floodproofing/Retrofitting Preference Matrix for Valley house.....	6-61
Figure 6-46.	Floodwall dimensions for the Valley house floodwall .....	6-62
Figure 6-47.	Plan drawing for Valley house floodwall or levee.....	6-63
Figure 6-48.	Valley House levee cross-sectional dimensions.....	6-64
Figure 6-49.	Interior Drainage Computation Worksheet for Valley House floodwall or levee.....	6-65
Figure 6-50.	Topographic map showing location of Valley house .....	6-66
Figure 6-51.	FIRMette for Valley house .....	6-67
Figure 6-52.	Elevation certificate excerpt for Valley house .....	6-68
Figure 6-53.	Tax card for Valley House .....	6-69
Figure 6-54.	Interior sump pump for a residential floodwall.....	6-70
Figure 6-55.	Brick-faced residential floodwall and access stairs.....	6-70
Figure 6-56.	Residential levee.....	6-71
Figure 6-57.	Driveway access over a residential levee .....	6-71

## List of Tables

### Chapter 1

Table 1-1.	Advantages and Disadvantages of Elevation .....	1-10
Table 1-2.	Advantages and Disadvantages of Relocation .....	1-12
Table 1-3.	Advantages and Disadvantages of Dry Floodproofing .....	1-14
Table 1-4.	Advantages and Disadvantages of Wet Floodproofing .....	1-16
Table 1-5.	Advantages and Disadvantages of Floodways and Levees .....	1-18

### Chapter 2

Table 2-1.	Summary of Key NFIP Requirements for Zone A.....	2-12
------------	--	------

### Chapter 3

Table 3-1.	Relative Costs of Elevating a Home.....	3-6
Table 3-2.	Relative Costs of Relocation.....	3-7
Table 3-3.	Relative Costs of Floodwalls and Levees .....	3-7
Table 3-4.	Relative Costs of Wet Floodproofing.....	3-7
Table 3-5.	Relative Costs and Risks of Floodproofing Methods .....	3-8
Table 3-6.	Flood Risk .....	3-9

### Chapter 4

Table 4-1.	Floodway Data Summary Table for Big Branch (Stream 21) .....	4-6
Table 4-2.	Summary of Coastal Analysis for the Atlantic Ocean Flooding Source .....	4-8
Table 4-3.	Effective Equivalent Fluid Weight of Submerged Soil and Water.....	4-12
Table 4-4.	Soil Type Definitions Based on USDA Unified Soil Classification System.....	4-13
Table 4-5.	Drag Coefficients for Ratios of Width to Height (w/h).....	4-17
Table 4-6.	Depth Coefficient ( $C_D$ ) by Flood Hazard Zone and Water Depth .....	4-23
Table 4-7.	Values of Blockage Coefficient ( $C_B$ ) .....	4-23
Table 4-8.	Typical Allowable Bearing Capacity by Soil Type Shown in Table 4-4 .....	4-41

Table 4-9.	Scour Factor for Flow Angle of Attack, $K$ .....	4-46
Table 4-10.	Typical Values of Coefficient of Permeability $K$ for Soils.....	4-49

## **Chapter 5**

Table 5-1.	Approximate Bearing Capacity for Masonry Wall Types.....	5-16
Table 5-2.	Presumptive Vertical Load-Bearing Capacities for Different Materials .....	5-16
Table 5-3.	Weights of Construction Types.....	5-18

## **Chapter 5D**

Table 5D-1.	Essential Equipment/Appliances to Operate from Emergency Power Source .....	5D-43
Table 5D-2.	Typical Electrical Appliance Loads.....	5D-45
Table 5D-3.	Example of Maximum Generator Sizing Procedure .....	5D-46
Table 5D-4.	Example Step Sequence Manual Start – Minimum Generator Sizing.....	5D-46
Table 5D-5.	Minimum Panel Bus Sizes .....	5D-48
Table 5D-6.	Emergency Panel Specification Criteria .....	5D-49

## **Chapter 5F**

Table 5F-1.	Soil Factors for Floodwall Design.....	5F-13
Table 5F-2.	Assumed Soil Factors for Simplified Floodwall Design.....	5F-30
Table 5F-3.	Typical Floodwall Dimensions for Clean, Dense Sand and Gravel Soil Types (GW, GP, SW, SP) .....	5F-30
Table 5F-4.	Typical Floodwall Dimensions for Dirty Sand and Gravel of Restricted Permeability Soil Types (GM, GM-GP, SM, SM-SP) .....	5F-31
Table 5F-5.	Moment ( $\beta$ ) and Deflection ( $\alpha$ ) Coefficients.....	5F-35
Table 5F-6.	Stone Protection Layer Guidance .....	5F-52

## **Chapter 6**

Table 6-1.	Summary of Flood Elevations and Discharges for the Truman House .....	6-4
Table 6-2.	Summary of Dead Load Calculations for the Truman House .....	6-11
Table 6-3.	Summary of Horizontal and Vertical Load Combinations for the Truman House .....	6-12

Table 6-4.	Stillwater Elevations for the Chester House.....	6-26
Table 6-5.	Summary of Horizontal and Vertical Load Combinations for the Chester House .....	6-32
Table 6-6.	Summary of Damages for the Borges House .....	6-43
Table 6-7.	Summary of Horizontal and Vertical Load Combinations for the Borges House Combination .....	6-49
Table 6-8.	Summary of Damages for Valley House.....	6-60

## List of Equations

### Chapter 4

Equation 4-1:	Flood Depth .....	4-9
Equation 4-2:	Common Definition of Design Flood Elevation.....	4-9
Equation 4-3:	Floodproofing Design Depth .....	4-10
Equation 4-4:	Lateral Hydrostatic Forces.....	4-12
Equation 4-5:	Submerged Soil and Water Forces .....	4-14
Equation 4-6:	Buoyancy Forces .....	4-15
Equation 4-7:	Conversion of Low Velocity Flow to Equivalent Head .....	4-17
Equation 4-8:	Conversion of Equivalent Head to Equivalent Hydrostatic Force .....	4-17
Equation 4-9:	High Velocity Hydrodynamic Pressure .....	4-20
Equation 4-10:	Total Hydrodynamic Force .....	4-20
Equation 4-11:	Normal Impact Loads.....	4-22
Equation 4-12:	Runoff Quantity in an Enclosed Area .....	4-26
Equation 4-13:	Runoff Quantity From Higher Ground into a Partially Enclosed Area.....	4-27
Equation 4-14:	Seepage Flow Rate Through a Floodwall or Levee.....	4-28
Equation 4-15:	Minimum Discharge for Pump Installation .....	4-28
Equation 4-16:	Allowable Bearing Capacity .....	4-40
Equation 4-17:	Maximum Potential Scour at Embankment Toe .....	4-44
Equation 4-18:	Localized Scour Around Vertical Pile .....	4-45

## CONTENTS

---

Equation 4-19:	Localized Scour Around Vertical Enclosure .....	4-45
Equation 4-20:	Volume of Seepage .....	4-49

### Chapter 5

Equation 5-1:	Determining Footing Size .....	5-14
Equation 5-2:	Maximum Loading of Existing Footing .....	5-14
Equation 5-3:	Bearing Capacity of Existing Strip Footing .....	5-14
Equation 5-4:	Bearing Capacity of Existing Strip Footing .....	5-15
Equation 5-5:	Calculation of Live Loads .....	5-20
Equation 5-6:	Calculation of Tributary Area for Load-bearing Walls .....	5-20
Equation 5-7:	Calculation of Tributary Area for Center Girder .....	5-21
Equation 5-8:	Calculation of Tributary Area for Columns .....	5-21
Equation 5-9:	Calculation of Wall/Column Loads .....	5-23
Equation 5-10:	Calculation of Wall/Column Loads .....	5-23
Equation 5-11:	Calculation of Total Load Carried by the Wall or Column to the Footing or Foundation .....	5-24

### Chapter 5F

Equation 5F-1:	Buoyancy on a Floodwall .....	5F-15
Equation 5F-2:	Floodwall Weight .....	5F-16
Equation 5F-3:	Footing Weight .....	5F-16
Equation 5F-4:	Weight of Soil Over Floodwall Toe .....	5F-17
Equation 5F-5:	Weight of Soil Over Floodwall Heel .....	5F-17
Equation 5F-6:	Weight of Water Above Floodwall Heel .....	5F-18
Equation 5F-7:	Total Gravity Forces Per Linear Foot of Wall .....	5F-18
Equation 5F-8:	Net Vertical Force .....	5F-19
Equation 5F-9:	Sliding Forces .....	5F-20
Equation 5F-10:	Frictional Force .....	5F-21

Equation 5F-11: Cohesion Force .....	5F-21
Equation 5F-12: Saturated Soil Force Over the Toe.....	5F-22
Equation 5F-13: Sum of Resisting Forces to Sliding .....	5F-22
Equation 5F-14: Factor of Safety Against Sliding .....	5F-23
Equation 5F-15: Sum of Overturning Moments.....	5F-24
Equation 5F-16: Sum of Resisting Moments .....	5F-25
Equation 5F-17: Factor of Safety Against Overturning .....	5F-26
Equation 5F-18: Eccentricity.....	5F-26
Equation 5F-19: Soil Pressure.....	5F-27
Equation 5F-20: Cross-Sectional Area of Reinforcing Steel .....	5F-28
Equation 5F-21: Plate Thickness Due to Bending Stresses.....	5F-34
Equation 5F-22: Plate Thickness Due to Deflection Stresses.....	5F-34
Equation 5F-23: Bending Moment.....	5F-36
Equation 5F-24: Bending Stress .....	5F-36
Equation 5F-25: Shear Force .....	5F-37
Equation 5F-26: Shear Stress .....	5F-37
Equation 5F-27: Plate Deflection for a One-Way Span .....	5F-38
Equation 5F-28: Allowable Deflection.....	5F-38

## **Chapter 5W**

Equation 5W-1: Net Buoyancy Force on a Tank.....	5W-17
Equation 5W-2: Concrete Volume Required to Offset Buoyancy .....	5W-17







# 1 Introduction to Retrofitting

*Retrofitting is any change made to an existing structure to reduce or eliminate the possibility of damage to that structure from flooding, erosion, high winds, earthquakes, or other hazards. The focus of this manual is on retrofitting buildings that are subject to flooding. The following sections describe the purpose, audience, and organization of the manual.*

## 1.1 Goals and Intended Users

This manual has been prepared by the Federal Emergency Management Agency (FEMA) with assistance from other groups to assist local governments, engineers, architects, and property owners involved in planning and implementing residential flood retrofitting projects. Its objective is to provide engineering design and economic guidance to engineers, architects, and local code officials about what constitutes technically feasible and cost-effective retrofitting measures for flood-prone residential structures.



### NOTE

Other flood-related technical resources are available through Federal agencies such as FEMA, the U.S. Army Corps of Engineers (USACE), and the Natural Resources Conservation Service (NRCS), as well as State, regional, and local agencies.

The focus of this manual is the retrofitting of one- to four-family residences subject to flooding situations without wave action. The manual presents various retrofitting measures that provide both active and passive efforts and employ both dry and wet floodproofing measures. These include elevation of the structure in place, relocation of the structure, construction of barriers (floodwalls and levees), dry floodproofing (sealants, closures, sump pumps, and backflow valves), and wet floodproofing (flood damage-resistant materials and protection of utilities and contents).

The goal of this manual is to capture state-of-the-art information and present it in an organized manner. To the maximum extent possible, existing data and current standards have been utilized as the cornerstone of this document. Detailed sections covering the evaluation, planning, and design of retrofitting measures are included along with case studies of completed retrofitting efforts. Methods for performing economic analyses of the various alternatives are presented.

The architect, engineer, or code official must recognize that retrofitting a residential structure influences how that structure reacts to hazards other than those associated with floodwaters, such as wind hazards. A holistic approach should be taken with regards to hazards when possible. Flood-related hazards such as water-borne ice and debris impact forces, erosion forces, and mudslide impacts, as well as non-flood-related hazards such as earthquake and wind forces, should also be considered in the retrofitting process. Retrofitting a structure to withstand only floodwater-generated forces may impair the structure's ability to withstand the multiple hazards mentioned above. Thus, it is important to approach the retrofitting method selection and design process with a multi-hazard perspective.



## WARNING

This manual will provide valuable assistance to the design professional. It is not intended to be used as a code or specification, nor as a replacement for the engineer's or architect's standard of performance.



## WARNING

Coastal situations subject to wave action are not addressed in this manual. For information on that area, the reader is referred to FEMA's *Coastal Construction Manual* (FEMA P-55, 2011, fourth edition), and the *USACE Shore Protection Manual* (USACE, 1984).

## 1.2 Organization of the Manual

This manual has six main chapters and eight appendices.

### Chapter 1: Introduction to Retrofitting

This chapter gives a basic overview of the different flood retrofit options. Each option is defined and the pros and cons to each retrofit type are discussed. An overview of the general retrofitting process is also given.

### Chapter 2: Regulatory Requirements

This chapter discusses the typical community floodplain management and building code environment. The role of local officials in a retrofitting project, the various tenets of the National Flood Insurance Program (NFIP), and the compatibility of items covered in the International Building Code (IBC) series are discussed.

**Chapter 3: Parameters of Retrofitting**

This chapter presents the factors that influence retrofitting decisions and the intimate role they play in choosing a retrofit method. The chapter provides two generic retrofitting matrices that were designed to help the designer narrow the range of floodproofing options.

**Chapter 4: Determination of Hazards**

This chapter gives guidance on how to focus on the specific retrofitting solution that is most applicable for the residential structure being evaluated.

**Chapter 5: General Design Practices**

This chapter provides step-by-step design processes for each retrofitting measure. (Note: Each retrofitting measure has its own tab and is organized as a subchapter.)

**Chapter 6: Case Studies**

This chapter is a collection of information on the actual retrofitting of specific residential structures.

**Appendix A: Sources of FEMA Funding**

This appendix discusses Increased Cost of Compliance Coverage (ICC) and includes a summary of the Hazard Mitigation Assistance (HMA) grant programs and references to additional information.

**Appendix B: Understanding the FEMA Benefit-Cost Process**

The appendix emphasizes the importance of benefit-cost analysis (BCA) for FEMA grant funding, clarifies the input data required to run a BCA module, and includes references to additional information.

**Appendix C: Sample Design Calculations**

This appendix includes detailed sample design calculations for elevation, dry floodproofing, wet floodproofing, and floodwall and levee retrofit problems.

**Appendix D: Alluvial Fan Flooding**

This appendix includes a description of alluvial fan flooding and its associated hazards, along with regulatory and design considerations in alluvial fan flooding areas.

**Appendix E: References**

This appendix includes a list of references cited throughout this publication.

**Appendix F: Other Resources**

This appendix includes a list of other resources that may be of interest.

**Appendix G: Summary of NFIP Requirements and Best Practices**

This appendix includes a table that is a summary of selected key NFIP provisions, and recommended best practices for exceeding the requirements. It cross-references citations from the I-Codes and other publications, including the American Society of Civil Engineers (ASCE) engineering standards.

**Appendix H: Acronyms**

This appendix includes acronyms used in this publication.

## Icons

Throughout this manual, the following icons are used, indicating:



**Special Note:** Significant or interesting information



**Terminology:** Definition or explanation of pertinent terms



**Cross Reference:** Reference to another relevant part of the text or another source of information



**Equation:** Use of a mathematical equation



**Warning:** Special cautions need to be exercised

## 1.3 Methods of Retrofitting

Retrofitting measures for flood hazards include the following:



**Elevation:** The elevation of the existing structure on fill or foundation elements such as solid perimeter walls, piers, posts, columns, or pilings.



**Relocation:** Relocating the existing structure outside the identified floodplain.



**Dry Floodproofing:** Strengthening of existing foundations, floors, and walls to withstand flood forces while making the structure watertight.



### CROSS REFERENCE

See page 1-18 for general cautions to consider in the implementation of a retrofitting measure.



### COST

Cost is an important factor to consider in elevating structures. As an example, lighter wood-frame structures are easier and often cheaper to raise than masonry structures. Masonry structures are not only more expensive to raise, but are also susceptible to cracks.



**Wet Floodproofing:** Making utilities, structural components, and contents flood- and water-resistant during periods of flooding within the structure.



**Floodwalls/Levees:** The placement of floodwalls or levees around the structure.

Retrofitting measures can be passive or active in terms of necessary human intervention. Active or emergency retrofitting measures are effective only if there is sufficient warning time to mobilize labor and equipment necessary to implement the measures. Therefore, every effort should be made to design retrofitting measures that are passive and do not require human intervention to implement protection.

### 1.3.1 Elevation

Elevating a structure to prevent floodwaters from reaching damageable portions is an effective retrofitting technique. The structure is raised so that the lowest floor is at or above the Design Flood Elevation (DFE) to avoid damage from a base flood. Heavy-duty jacks are used to lift the existing structure. Cribbing supports the structure while a new or extended foundation is constructed below. In lieu of constructing new support walls, open foundations such as piers, posts, columns, and piles are often used. Elevating a structure on fill may also be an option in some situations. Closed foundations are not permitted in Zone V or Coastal A Zones.

While elevation may provide increased protection of a structure from floodwaters, other hazards must be considered before implementing this strategy. Elevated structures may encounter additional wind forces on wall and roof systems, and the existing footings may experience additional loading. Extended and open foundations (piers, posts, columns, and piles) are also subject to undermining, movement, and impact failures caused by seismic activity, erosion, scour, ice or debris flows, mudslides, and alluvial fan forces, among others.



#### NOTE

FEMA strongly encourages that flood retrofits provide protection to the DFE (or BFE plus 1 foot, whichever is higher). However, there may be situations where it is appropriate for the flood protection level to be lower. Homeowners and design professionals should meet with a local building official to discuss the selected retrofit measure and the elevation to which it will protect the home. The text and examples in this manual assume flood protection measures will be implemented to the DFE.



#### TERMINOLOGY: BASE FLOOD

Base flood is defined as the flood having a 1-percent chance of being equaled or exceeded in any given year. The Base Flood Elevation (BFE) is the elevation to which floodwaters rise during a base flood.



#### TERMINOLOGY: DFE

DFE is the regulatory flood elevation adopted by a local community. Typically, the DFE is the BFE plus any freeboard adopted by the community. The Flood Protection Elevation (FPE) or Flood Protection Level (FPL) is equal to the DFE (or BFE + 1 foot, whichever is higher). This manual uses the DFE.



### 1.3.1.1 Elevation on Solid Perimeter Foundation Walls

Elevation on solid perimeter foundation walls is normally used in areas of low to moderate water depth and velocity. After the structure is raised from its current foundation, the support walls can often be extended vertically using materials such as concrete masonry units (CMU) or cast-in-place concrete. Figure 1-1 shows an elevation on solid perimeter foundation walls and Figure 1-2 shows a home elevated on extended foundation walls. The structure is then set down on the extended walls. While this may seem to be the easiest solution to the problem of flooding, there are several important considerations.



#### NOTE

Refer to FEMA 347, *Above the Flood: Elevating Your Floodprone House* (FEMA, 2000), for details on the elevation of residential structures.

Depending on the structure and potential environmental loads (such as flood, wind, seismic, and snow), new, larger footings may have to be constructed. It may be necessary to reinforce both the footings and the walls using steel reinforcing bars to provide needed structural stability.

Deep floodwaters can generate loads great enough to collapse the structure regardless of the materials used. Constructing solid foundation walls with openings or vents will help alleviate the danger by allowing hydrostatic forces to be equalized on both sides. For new and substantially damaged or improved buildings, flood openings are required under the NFIP.

Figure 1-1.  
Elevation on solid  
perimeter foundation  
walls

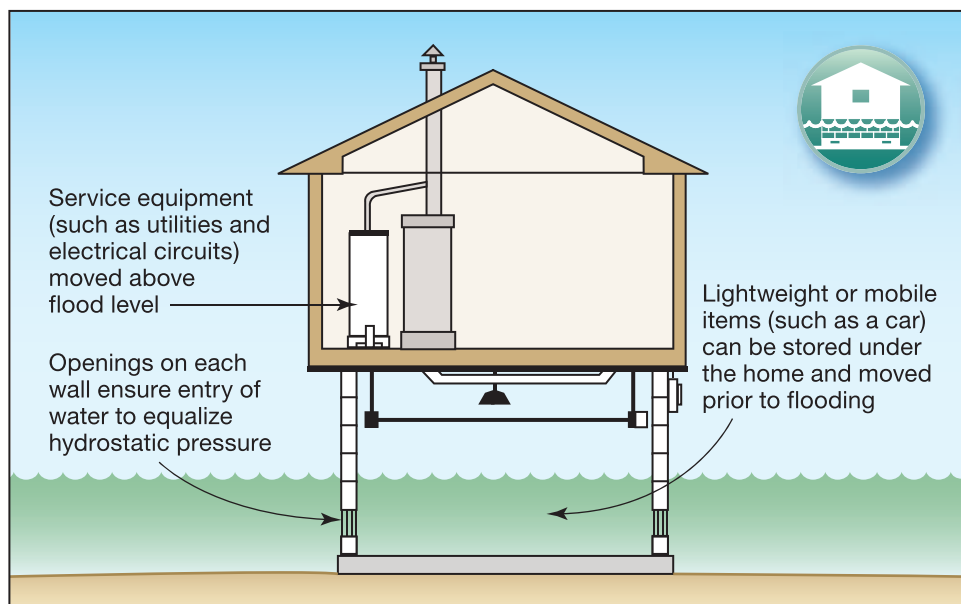



Figure 1-2.  
Elevation of existing  
residence on extended  
foundation walls

### 1.3.1.2 Elevation on Open Foundation Systems

Open foundation systems are vertical structural members that support the structure at key points without the support of a continuous foundation wall. Open foundation systems include piers, posts, columns, and piles.

#### Elevation on Piers

The most common example of an open foundation is piers, which are vertical structural members that are supported entirely by reinforced concrete footings. Despite their popularity in construction, piers are often the elevation technique least suited for withstanding significant horizontal flood forces. In conventional use, piers are designed primarily for vertical loading. However, when exposed to flooding, piers may also experience horizontal loads due to moving floodwater or debris impact forces. Other environmental loads, such as seismic loads, can also create significant horizontal forces. For this reason, piers used in retrofitting must not only be substantial enough to support the vertical load of the structure, but also must be sufficient enough to resist a range of horizontal forces that may occur.

Piers are generally used in shallow depth flooding conditions with low-velocity ice, debris, and water flow potential, and are normally constructed of either CMU or cast-in-place concrete. In either case, steel reinforcing should be used for both the pier and its support footing. The reinforced elements should be tied together to prevent separation. There must also be suitable connections between the superstructure and piers to resist seismic, wind, and buoyancy (uplift) forces. Overturning can occur from the combination of vertical and horizontal forces on a shallow depth pier foundation. Figure 1-3 shows a schematic of a residential structure on piers.

Figure 1-3.  
Elevation on piers

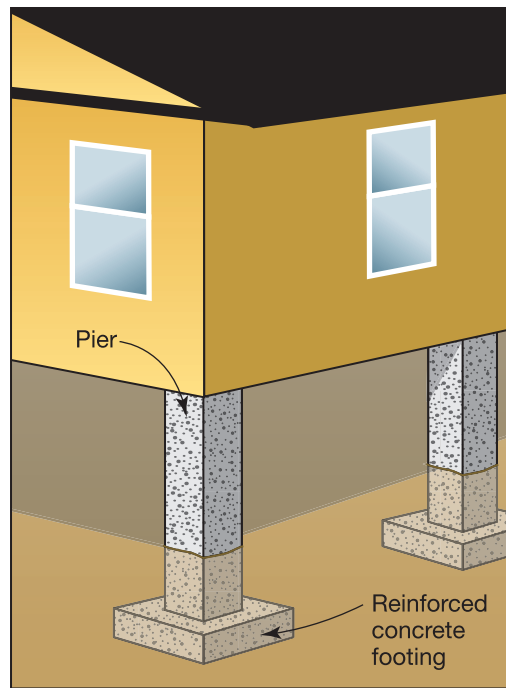

### Elevation on Posts or Columns

Elevation on posts or columns is frequently used when flood conditions involve moderate depths and velocities. Made of wood, steel, or precast reinforced concrete, posts are generally square-shaped to permit easy attachment to the house structure. However, round posts may also be used. Set in pre-dug holes, posts are usually anchored or embedded in concrete pads to handle substantial loading requirements. Concrete, earth, gravel, or crushed stone is usually backfilled into the hole and around the base of the post.

Figure 1-4.  
Elevation on posts or columns

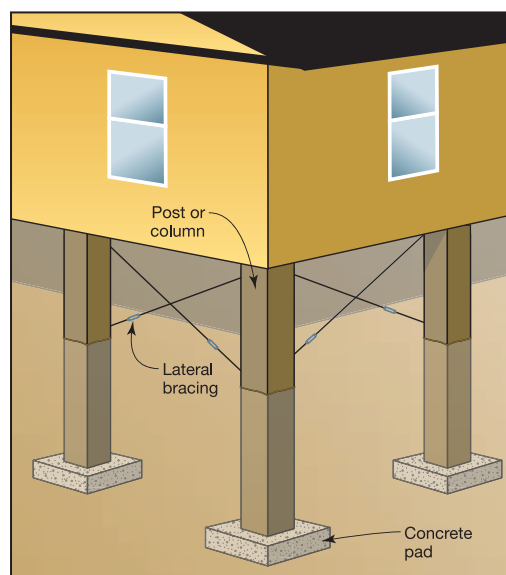

### NOTE

Columns differ from posts in the size of their application. Posts are small columns.



While piers are designed to act as individual support units, posts normally must be braced. There are a variety of bracing techniques such as wood knee and cross bracing, steel rods, and guy wires. Cost, local flood conditions, loads, the availability of building materials, and local construction practices frequently influence which technique is used. Figure 1-4 shows an example of a post and column foundation.

### Elevation on Piles

Piles differ from posts in that they are generally driven, jetted, or set (augured) deeper into the ground. As such, they are less susceptible to the effects of high-velocity floodwaters, scouring, and debris impact. Piles must either rest on a support layer, such as bedrock, or be driven deep enough to create enough friction to transfer the anticipated loads to the surrounding soil. Piles are often made of wood, although steel and reinforced precast or prestressed concrete are also common in some areas. Similar to posts, they may also require bracing.

Because driving piles generally requires bulky, heavy construction machinery, the effort to replace the foundation often requires that an existing home be moved off the foundation, set on cribbing until the operation is complete, and then replaced. The additional cost and space needs often preclude the use of piles in areas where alternative elevation methods for retrofitting are technically feasible.

Several innovative methods have been developed for setting piles. These include jetting exterior piles in at an angle using high-pressure water flow, and trenching, or auguring, holes for interior pile placement. Augured piles utilize a concrete footing for anchoring instead of friction forces. This measure requires that the existing home be raised several feet above its final elevation to allow room for workers to install the piles. Jetting and auguring piles reduces the uplift capacity compared to driven piles. Figures 1-5 and 1-6 show homes elevated on piles.

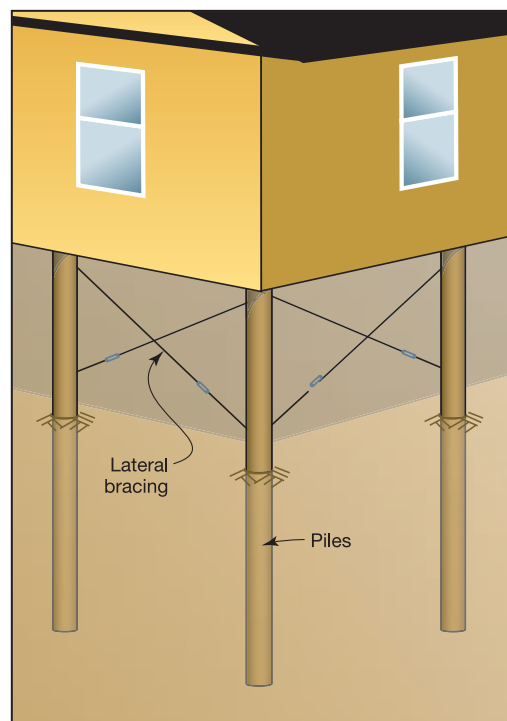

Figure 1-5.  
Elevation on piles

**Figure 1-6.**  
Structure elevated on piles



Table 1-1 provides advantages and disadvantages associated with elevating a home.

**Table 1-1. Advantages and Disadvantages of Elevation**

Advantages	Disadvantages
Brings a substantially damaged or improved building into compliance with the NFIP if the lowest horizontal structural member of the lowest floor is elevated to the BFE	May be cost-prohibitive
Reduces flood risk to the structure and its contents	May adversely affect the structure's appearance
Eliminates the need to relocate vulnerable items above the flood level during flooding	Does not eliminate the need to evacuate during floods
Often reduces flood insurance premiums	May adversely affect access to the structure
Uses established techniques	Cannot be used in areas with high-velocity water flow, fast-moving ice or debris flow, or erosion unless special measures are taken
Can be initiated quickly because qualified contractors are often readily available	May require additional costs to bring the structure up to current building codes for plumbing, electrical, and energy systems
Reduces the physical, financial, and emotional strains that accompany flood events	Requires consideration of forces from wind and seismic hazards and possible changes to building design
Does not require the additional land that may be needed for floodwalls or levees	

NFIP = National Flood Insurance Program    BFE = Base Flood Elevation

### 1.3.2 Relocation

Relocation involves moving a structure to a location that is less prone to flooding or flood-related hazards such as erosion. The structure may be relocated to another portion of the current site or to a different site. The surest way to eliminate the risk of flood damage is to relocate the structure out of the floodplain. Relocation normally involves placing the structure on a wheeled vehicle, as shown in Figure 1-7. The structure is then transported to a new location and set on a new foundation.



**Figure 1-7.**  
Structure placed on  
a wheeled vehicle for  
relocation to a new site

Relocation is an appropriate measure in high hazard areas where continued occupancy is unsafe or owners want to be free from flood worries. It is also a viable option in communities that are considering using the resulting open space for more appropriate floodplain activities. Relocation may offer an alternative to elevation for substantially damaged structures that are required under local regulations to meet NFIP requirements.

Relocation of a structure requires steps that typically increase the cost of implementing this retrofitting method compared to elevation. These additional costs include moving the structure to its new location, purchase and preparation of a new site to receive the structure (with utilities), construction of a new foundation, and restoration of the old site. Most types and sizes of structures can be relocated either as a unit or in segments. One-story wood-frame houses are usually the easiest to move, particularly if they are located over a crawlspace or basement that provides easy access to floor joists. Smaller, lighter wood-frame structures may also be lifted with ordinary house-moving equipment and often can be moved without partitioning. Homes constructed of brick, concrete, or masonry are also movable, but usually with more difficulty and increased costs. A schematic of a home prepared to be relocated is shown in Figure 1-8.

Structural relocation professionals should help owners to consider many factors in the decision to relocate. The structural soundness should be thoroughly checked and arrangements should be made for temporary housing and storage of belongings. Many States and communities have requirements governing the movement of structures in public rights-of-way.

Figure 1-8.  
Structure to be relocated

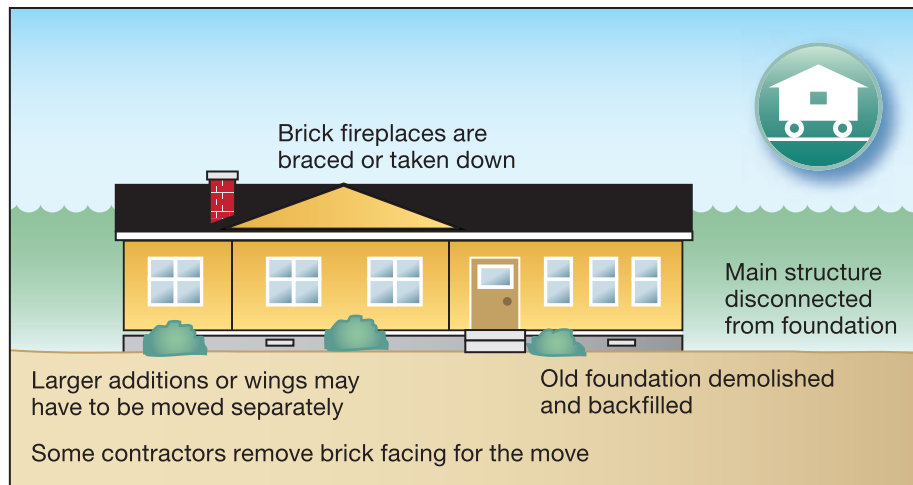

Table 1-2 provides advantages and disadvantages associated with relocating a home.

Table 1-2. Advantages and Disadvantages of Relocation

Advantages	Disadvantages
Allows substantially damaged or improved structure to be brought into compliance with the NFIP	May be cost-prohibitive
Significantly reduces flood risk to the structure and its contents	A new site must be located
Uses established techniques	Requires addressing disposition of the flood-prone site
Can be initiated quickly because qualified contractors are often readily available	May require additional costs to bring the structure up to current building codes for plumbing, electrical, and energy systems
Can eliminate the need to purchase flood insurance or reduce the premium because the home is no longer in the floodplain	
Reduces the physical, financial, and emotional strains that accompany flood events	

NFIP = National Flood Insurance Program

### 1.3.3 Dry Floodproofing

In dry floodproofing, the portion of a structure that is below the DFE (walls and other exterior components) is sealed to make it watertight and substantially impermeable to floodwaters. Such watertight impervious membrane sealant systems can include wall coatings, waterproofing compounds, impermeable sheeting and supplemental impermeable wall systems, such as cast-in-place concrete. Doors, windows, sewer and water lines, and vents are closed with permanent or removable shields or valves. Figure 1-9 is a schematic of a dry floodproofed home.

The expected duration of flooding is critical when deciding which sealant systems to use because seepage can increase over time, rendering the floodproofing ineffective. Waterproofing compounds, sheeting, or

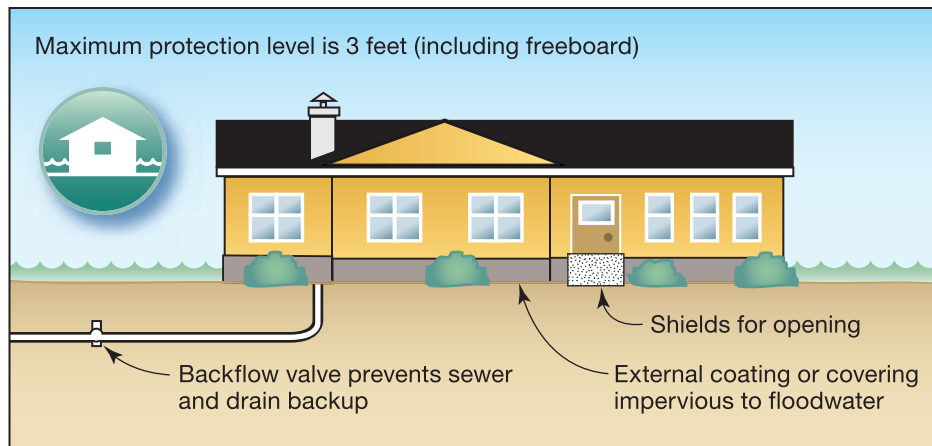

Figure 1-9.  
Dry floodproofed  
structure

sheathing may fail or deteriorate if exposed to floodwaters for extended periods. Sealant systems are also subject to damage (puncture) in areas that experience water flow of significant velocity, or ice or debris flow. The USACE National Flood Proofing Committee has investigated the effect of various depths of water on masonry walls. The results of their work show that, as a general rule, no more than 3 feet of water should be allowed on a non-reinforced concrete block wall that has not previously been designed and constructed to withstand flood loads. Therefore, application of sealants and shields should involve a determination of the structural soundness of a building and its corresponding ability to resist flood and flood-related loads. An engineer should be involved in any design of dry floodproofing mitigation systems so that they can evaluate the building and run calculations to determine the appropriate height of dry floodproofing. Research in this subject area is available in *Flood Proofing Tests – Tests of Materials and Systems for Flood Proofing Structures* (USACE, 1988).



#### WARNING

Dry floodproofing is not allowed under the NFIP for new and substantially damaged or improved residential structures located in a SFHA. Additional information on dry floodproofing can be obtained from FEMA Technical Bulletin 3-93, *Non-Residential Floodproofing Requirements and Certification for Buildings Located in Special Flood Hazard Areas in Accordance with the NFIP* (FEMA, 1993). Non-residential techniques are also applicable in residential situations.

Table 2 of FEMA's NFIP Technical Bulletin 2-08, *Flood Damage-Resistant Materials Requirements for Buildings Located in Special Flood Hazard Areas in accordance with the National Flood Insurance Program* (FEMA, 2008a), provides class ratings with regards to flood damage-resistance for standard construction materials. It needs to be noted, however, that the materials are deemed "acceptable" and "unacceptable" for use below the BFE in a Special Flood Hazard Area (SFHA) within the confines of the NFIP. The NFIP does not allow for dry floodproofing for new and substantially damaged or improved residential structures located in a SFHA. Table 1-3 provides advantages and disadvantages associated with dry floodproofing a home.



#### WARNING

Even brick or concrete block walls should not be floodproofed above a height of 3 feet (without an extensive engineering analysis) due to the danger of structural failure from excessive hydrostatic and other flood-related forces.



Table 1-3. Advantages and Disadvantages of Dry Floodproofing

Advantages	Disadvantages
Reduces the flood risk to the structure and contents if the design flood level is not exceeded	Does not satisfy the NFIP requirement for bringing substantially damaged or improved residential structures into compliance
May be less costly than other retrofitting measures	Requires ongoing maintenance
Does not require the extra land that may be needed for floodwalls or reduced levees	Does not reduce flood insurance premiums for residential structures
Reduces the physical, financial, and emotional strains that accompany flood events	Usually requires human intervention and adequate warning time for installation of protective measures
Retains the structure in its present environment and may avoid significant changes in appearance	May not provide protection if measures fail or the flood event exceeds the design parameters of the measure
	May result in more damage than flooding if design loads are exceeded, walls collapse, floors buckle, or the building floats
	Does not eliminate the need to evacuate during floods
	May adversely affect the appearance of the building if shields are not aesthetically pleasing
	May not reduce damage to the exterior of the building and other property
	May lead to damage of the building and its contents if the sealant system leaks

NFIP = National Flood Insurance Program

Dry floodproofing is also not recommended for structures with a basement. These types of structures can be susceptible to significant lateral and uplift (buoyancy) forces. Dry floodproofing may not be appropriate for a wood-frame superstructure; however, in some instances, buildings constructed of concrete block or faced with brick veneer may be considered for dry floodproofing retrofits. Weaker construction materials, such as wood-frame superstructure with siding, will often fail at much lower water depths from hydrostatic forces.



**NOTE**

The designer should consider incorporating freeboard into the 3-foot height constraint as a factor of safety against structural failure (limiting flood height to a maximum of 2 feet). Other factors of safety might include additional pumping capacity and stiffened walls.

**1.3.4 Wet Floodproofing**

Another approach to retrofitting involves modifying a structure to allow floodwaters to enter it in such a way that damage to the structure and its contents is minimized. This type of protection is classified as wet floodproofing. A schematic of a home that is wet floodproofed is shown in Figure 1-10.



**WARNING**

Wet floodproofing is not allowed under the NFIP for new and substantially damaged or improved structures located in a SFHA. Refer to FEMA's Technical Bulletin 7-93, *Wet Floodproofing Requirements for Structures Located in Special Flood Hazard Areas in Accordance with the NFIP* (FEMA, 1993).

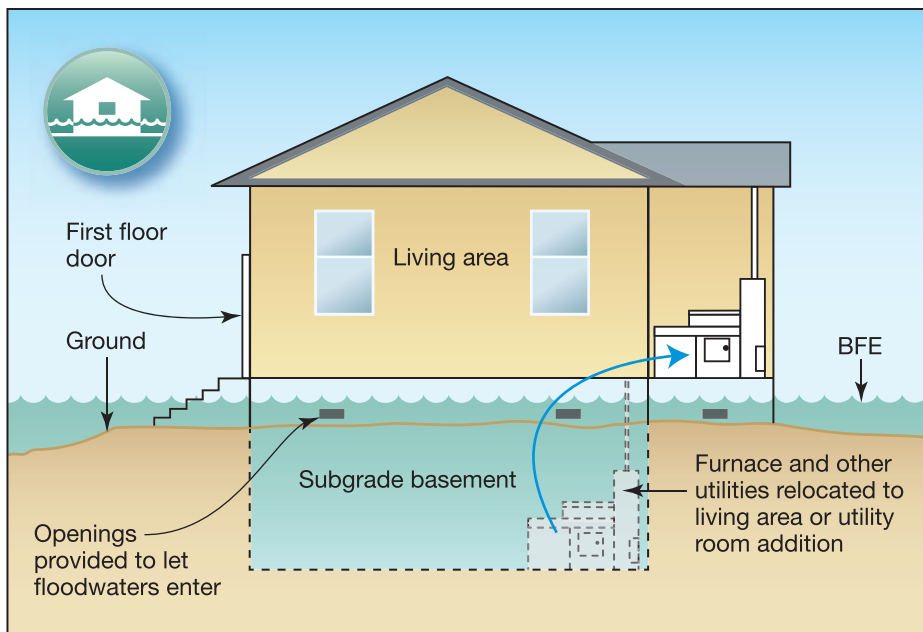

Figure 1-10.  
Wet floodproofed  
structure

Wet floodproofing is often used when all other mitigation techniques are technically infeasible or are too costly. Wet floodproofing is generally appropriate if a structure has available space where damageable items can be stored temporarily. Utilities and furnaces may need to be relocated or protected along with other non-movable items with flood damage-resistant building materials. Wet floodproofing may also be appropriate for structures with basements and crawlspaces that cannot be protected technically or cost-effectively by other retrofitting measures.



#### NOTE

For additional information, refer to FEMA 348, *Protecting Building Utilities From Flood Damage: Principles and Practices for the Design and Construction of Flood Resistant Building Utility Systems* (FEMA, 1999).

Compared with the more extensive flood protection measures described in this manual, wet floodproofing is generally the least expensive. The major costs of this measure involve the rearrangement of utility systems, installation of flood damage-resistant materials, acquisition of labor and equipment to move items, and organization of cleanup when floodwaters recede. Major disruptions to structure occupancy often result during conditions of flooding.

Table 2 in FEMA's NFIP Technical Bulletin 2-08, *Flood Damage-Resistant Materials Requirements for Buildings Located in Special Flood Hazard Areas in accordance with the National Flood Insurance Program* (FEMA, 2008a), provides class ratings with regards to flood damage-resistance for standard construction materials. It needs to be noted, however, that the materials are deemed "acceptable" and "unacceptable" for use below the BFE in a SFHA within the confines of the NFIP. The NFIP does not allow for wet floodproofing for new and substantially damaged or improved residential structures located in a SFHA.

Table 1-4 provides advantages and disadvantages associated with wet floodproofing a home.

Table 1-4. Advantages and Disadvantages of Wet Floodproofing

Advantages	Disadvantages
Reduces the risk of flood damage to a building and its contents, even with minor mitigation	Does not satisfy the NFIP requirement for bringing substantially damaged or improved structures into compliance
Greatly reduces loads on walls and floors due to equalized hydrostatic pressure	Usually requires a flood warning to prepare the building and contents for flooding
May be eligible for flood insurance coverage of cost of relocating or storing contents, except basement contents, after a flood warning is issued	Requires human intervention to evacuate contents from the flood-prone area
Costs less than other measures	Results in a structure that is wet on the inside and possibly contaminated by sewage, chemicals, and other materials borne by floodwaters and may require extensive cleanup
Does not require extra land	Does not eliminate the need to evacuate during floods
Reduces the physical, financial, and emotional strains that accompany flood events	May make the structure uninhabitable for some period after flooding
	Limits the use of the floodable area
	May require ongoing maintenance
	May require additional costs to bring the structure up to current building codes for plumbing, electrical, and energy systems
	Requires care when pumping out basements to avoid foundation wall collapse

NFIP = National Flood Insurance Program

### 1.3.5 Floodwalls and Levees

Another retrofitting approach is to construct a barrier between the structure and source of flooding. There are two basic types of barriers: floodwalls and levees. They can be built to any height, but are usually limited to 4 feet for floodwalls and 6 feet for levees due to cost, aesthetics, access, water pressure, and space. Local zoning and building codes may also restrict use, size, and location.



**NOTE**

Generally, residential floodwalls are only cost-beneficial at providing protection up to 4 feet and levees up to 6 feet, including 1 foot of freeboard.

Floodwalls are engineered barriers designed to keep floodwaters from coming into contact with the structure. Floodwalls can be constructed in a wide variety of shapes and sizes, but are typically built of reinforced concrete and/or masonry materials.

A floodwall can surround an entire structure or, depending on the flood levels, site topography, and design preferences; it can also protect isolated structure openings such as doors, windows, or basement entrances. Floodwalls can be designed as attractive features to a residence, utilizing decorative bricks or blocks, landscaping, and garden areas, or they can be designed for utility at a considerable savings in cost.

Figure 1-11 shows a schematic of a home protected by a floodwall and a levee.



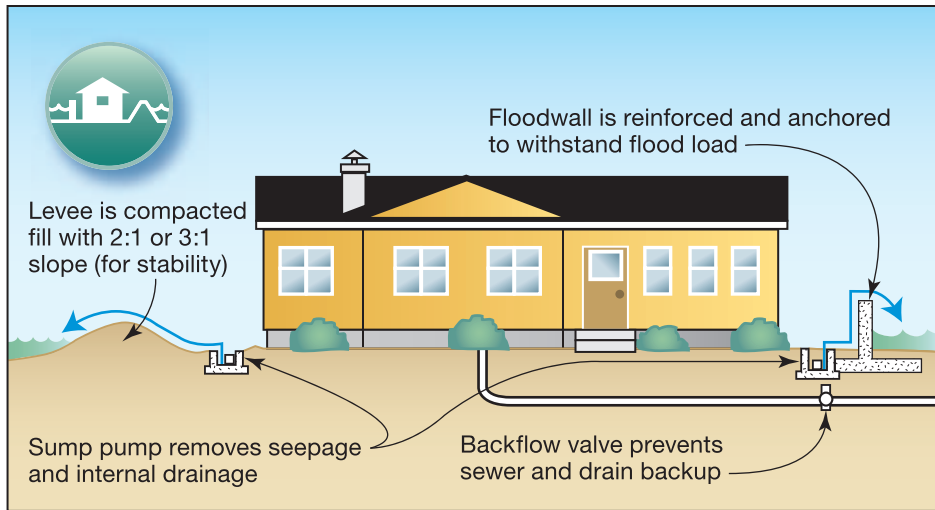

Figure 1-11.  
Structure protected by floodwall and levee

Because their cost is usually greater than that of levees, floodwalls would normally be considered only on sites that are too small to have room for levees or where flood velocities may erode earthen levees. Some owners may believe that floodwalls are more aesthetically pleasing and allow preservation of site features, such as trees. Figure 1-12 shows a home protected by a levee.



**WARNING**

While floodwalls and levees are allowed under NFIP regulations, they do not make a non-compliant structure compliant with the NFIP.

A levee is typically a compacted earthen structure that blocks floodwaters from coming into contact with the structure. To be effective over time, levees must be constructed of suitable materials (i.e., impervious soils) and with correct side slopes for stability. Levees may completely surround the structure or tie to high ground at each end.



Figure 1-12.  
Home protected by a levee

Levees are generally limited to homes where floodwaters are less than 5 feet deep. Otherwise, the cost and the land area required for such barriers usually make them impractical for the average owner.

Special design considerations must be taken into account when floodwalls or levees are used to protect homes with basements because they are susceptible to seepage that can result in hydrostatic and saturated soil pressure on foundation elements.

The costs of floodwalls and levees can vary greatly, depending on height, length, availability of construction materials, labor, access closures, and the interior drainage system. A levee could be constructed at a lower cost if the proper fill material is available nearby.

Table 1-5 provides advantages and disadvantages associated with protecting a home with a floodwall or a levee.



**NOTE**

Provisions for closing access openings must be included as part of the floodwall or levee design.

**Table 1-5. Advantages and Disadvantages of Floodways and Levees**

Advantages	Disadvantages
Protects the area around the structure from inundation without significant changes to the structure	Does not satisfy the NFIP requirements for bringing substantially damaged or improved structures into compliance
Eliminates pressure from floodwaters that would cause structural damage to the home or other structures in the protected area	May fail or be overtopped by large floods or floods of long duration
Costs less to build than elevating or relocating the structure	May be expensive
Allows the structure to be occupied during construction	Requires periodic maintenance
Reduces flood risk to the structure and its contents	Requires interior drainage
Reduces the physical, financial, and emotional strains that accompany flood events	May affect local drainage, possibly resulting in water problems for others
	Does not reduce flood insurance premiums
	May restrict access to structure
	Requires considerable land (levees only)
	Does not eliminate the need to evacuate during floods
	May require warning and human intervention for closures
	May violate applicable codes or regulations

NFIP = National Flood Insurance Program

## 1.4 Considerations When Retrofitting

Appropriately applied retrofitting measures have several advantages over other damage reduction methods. Individual owners can undertake retrofitting projects without waiting for government action to construct flood control projects. Retrofitting may also provide protection in areas where large structural projects, such as dams or major waterway improvements, are not feasible, warranted, or appropriate. Some general considerations when implementing a retrofitting strategy include:

- Substantial damage or improvement requirements under the NFIP, local building codes, and floodplain management ordinances render some retrofitting measures illegal.
- Codes, ordinances, and regulations for other restrictions, such as setbacks and wetlands, should be observed.
- Retrofitted structures should not be used nor occupied during conditions of flooding.
- Most retrofitting measures should be designed and constructed by experienced professionals (engineers, architects, or contractors) to ensure proper consideration of all factors influencing effectiveness.
- Most retrofitting measures cannot be installed and forgotten. Maintenance must be performed on a scheduled basis to ensure that the retrofitting measures adequately protect the structure over time.
- Floods may exceed the level of protection provided in retrofitting measures. In addition to implementing these protective measures, owners should consider continuing (and may be required to purchase) flood insurance. In some cases, owners may be required by lending institutions to continue flood insurance coverage.
- When human intervention is most often needed for successful flood protection, a plan of action must be in place and an awareness of flood conditions is required.

## 1.5 Retrofitting Process

A good retrofitting project should follow a careful path of exploration, fact finding, analysis, detailed design, and construction steps as depicted in Figure 1-13. The successful completion of a retrofitting project will require a series of homeowner coordination and design input meetings. Ultimately, the homeowner will be living with the retrofitting measure, so every effort should be made to incorporate the homeowner's concerns and preferences into the final product. The primary steps in the overall process are shown in Figure 1-13 and discussed in the following steps.

**Step 1. Homeowner Motivation:** The decision to consider retrofitting options usually stems from having experienced or witnessed a flooding event in or near the structure in question; having experienced substantial damage from a flood or an event other than a flood; or embarking on a substantial improvement, which requires



### NOTE

Within each of these steps, homeowners are involved in providing input into the evaluations, analyses, decisions, and design concepts to ensure that the final product meets their requirements. Finally, maintenance of the constructed retrofitting measure is the responsibility of the homeowner.

adherence to local floodplain regulations. The homeowner may contact other homeowners, community officials, contractors, or design professionals to obtain information on retrofitting techniques, available technical and financial assistance, and other possible options.

**Step 2. Parameters of Retrofitting:** The goal of this step is to conduct the necessary field investigations, regulatory reviews, and preliminary technical evaluations to select applicable and technically feasible retrofitting techniques that warrant further analysis.

**Step 3. Determination of Hazards:** This step involves the detailed analysis of flood, flood-related, and non-flood-related hazards and the evaluation of specific sites and structures to be retrofitted.

**Step 4. Benefit-Cost Analysis:** This step is critical in the overall ranking of technically feasible retrofitting techniques, and it combines an objective economic analysis of each retrofitting measure considered with any subjective decision factors introduced by the homeowner or others.

**Step 5. Design:** During this phase, specific retrofitting measures are designed, construction details developed, cost estimates prepared, and construction permits obtained.

**Step 6. Construction:** Upon final design approvals, a contractor is selected and the retrofitting measure is constructed.

**Step 7. Operation and Maintenance:** The development of a well-conceived operation and maintenance plan is critical to the overall success of the project.



## NOTE

You can download the newest version (Version 4.5.5) of the BCA software free of charge from the Web site: <http://www.fema.gov/government/grant/bca.shtm#1>.

Figure 1-13.  
Primary steps in  
retrofitting process

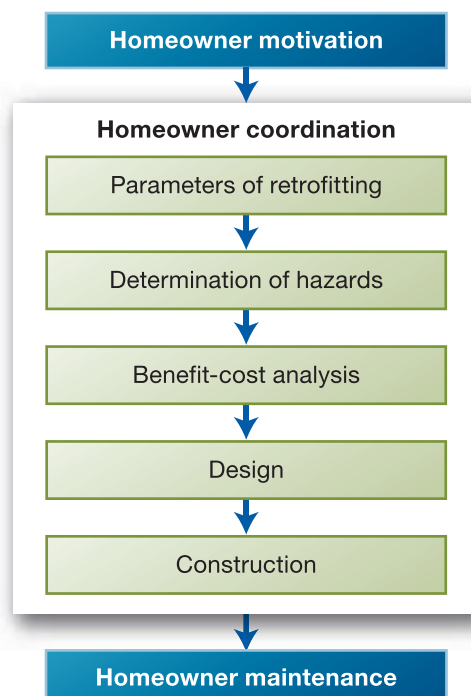

### 1.5.1 Other Retrofitting Guides

When considering retrofitting a structure, it is important to approach the retrofitting method selection and design process with a multi-hazard perspective. Improvements to a building that are made to increase resistance to the effects of natural hazards should focus on those items that will potentially return the largest benefit to the building owner. If the existing building is considered inadequate to resist natural hazard loads, retrofit improvements should be considered for the following building elements:

- Decks and porches
- Exterior metal (handrails, connectors, etc.)
- Windows and doors
- Foundation
- Exterior equipment
- Roof
- Siding

All relevant hazards to the home need be considered. FEMA has several other retrofit publications available:

- NFIP Technical Bulletins 1 through 11 (available at <http://www.fema.gov/plan/prevent/floodplain/techbul.shtm>)
- FEMA P-312, *Homeowner's Guide to Retrofitting* (FEMA, 2009a)
- FEMA 232, *Homebuilder's Guide to Earthquake-Resistant Design and Construction* (FEMA, 2006a)
- FEMA 347, *Above the Flood: Elevating Your Floodprone House* (FEMA, 2000a)
- FEMA P-348, *Protecting Building Utilities from Flood Damage: Principles and Practices for the Design and Construction of Flood Resistant Building Utility Systems* (FEMA, 1999a)
- FEMA 356, *Prestandard and Commentary for the Seismic Rehabilitation of Buildings* (FEMA, 2000b) later replaced by ASCE 41-06, *Seismic Rehabilitation of Existing Buildings* (ASCE, 2006)
- FEMA P-499, *Home Builder's Guide to Coastal Construction* (FEMA, 2010a)
  - Technical Fact Sheet Number 9.1: "Repairs, Remodeling, Additions, and Retrofitting – Flood"
  - Technical Fact Sheet Number 9.2: "Repairs, Remodeling, Additions, and Retrofitting – Wind"
- FEMA P-804, *Wind Retrofit Guide for Residential Buildings* (FEMA, 2010b)

Chapter 15 of FEMA P-55, *Coastal Construction Manual* (FEMA, 2011) also discusses retrofit options and solutions for different hazards, as well as the importance of retrofitting with a multi-hazard perspective.

An engineer or design professional should be consulted to ensure that a retrofit project for one hazard type will not impede the structure's resistance to other types of natural hazards.







# 2 Regulatory Requirements

Most flood retrofitting projects are regulated by local floodplain, zoning, and building codes, regulations, and ordinances. In addition to governing the extent and type of activities allowable in the regulatory floodplain, these codes and ordinances set construction standards and regulations. These construction standards and regulations must be followed in new construction as well as in substantial improvement and repair of substantially damaged buildings. The portions of these ordinances dealing with retrofitting are generally derived from guidance issued by FEMA under the NFIP, and USACE.

This chapter discusses the typical community floodplain management and building code environment, including:

- the various tenets of the NFIP;
- the role of local officials in a retrofitting project; and
- the compatibility of items covered in international building codes with the NFIP.

Each jurisdiction may adopt standards that are more restrictive than the minimum NFIP requirements, but this section will examine only the minimum Federal regulations governing construction in a SFHA. Adoption of national model building codes establishes a certain level of consistency between State and local jurisdictions. However, State and local governments often amend or adopt only portions of the national model building codes, so the extent to which local building codes are more, or less, stringent than minimum model code requirements can vary widely.



## NOTE

In individual communities, local regulations are the mechanism by which NFIP requirements are enforced. The reader is encouraged to contact local floodplain management and building code officials to determine if more restrictive requirements are in place.

## 2.1 National Flood Insurance Program

The NFIP is a voluntary program that operates through a partnership between the Federal Government and individual communities such as State, Tribal governments, counties, parishes, and incorporated cities, towns, townships, boroughs, and villages. The NFIP provides federally backed flood insurance to property owners and renters in participating communities. In return, each community adopts and enforces floodplain management regulations that meet or exceed the minimum NFIP requirements. The creation of the NFIP was a major step in the evolution of floodplain management. During the 1960s, Congress became concerned with problems related to the traditional methods of dealing with flood damage. It concluded:

- flood protection structures are expensive and cannot protect everyone;
- people are still building in floodplains and, therefore, are risking disaster;
- disaster relief is inadequate and expensive;
- the private insurance industry cannot sell affordable flood insurance because only those at significant risk will buy it; and
- Federal flood control programs are funded by all taxpayers, but they primarily help only those who live in the floodplains.

In 1968, Congress passed the National Flood Insurance Act to correct some of the shortcomings of the traditional flood control and flood relief programs. The Act created the NFIP to:

- guide future development away from flood hazard areas;
- require that new and substantially improved buildings be constructed to resist flood damage;
- provide floodplain residents and owners with financial assistance after floods, especially after smaller floods that do not warrant Federal disaster aid; and
- transfer some of the costs of flood losses from the taxpayers to floodplain property owners through flood insurance premiums.

Congress originally charged the Department of Housing and Urban Development's (HUD's) Federal Insurance Administration (FIA) with responsibility for the program. In 1979, the FIA and the NFIP were transferred to the newly created Federal Emergency Management Agency. Currently, the NFIP is administered by the Federal Insurance and Mitigation Administration (FIMA) within FEMA.

FEMA has focused particular attention on mitigating buildings and facilities subject to repetitive losses. A building is considered to be a repetitive loss structure when it has had at least two losses of \$1,000 or more within any



### CROSS REFERENCE

The floodplain management requirements of the NFIP are listed in the Code of Federal Regulations (CFR) Title 44, Chapter 1, Section 60.3 (44 CFR 60.3).



### NOTE

To obtain information on repetitive loss structures in your community, contact your State Community Rating System (CRS) program coordinator or your FEMA Regional office.



10-year period. There is an even more concerted effort to mitigate severe repetitive loss (SRL) properties. Severe repetitive loss is defined as either:

- (a) at least four NFIP claim payments (including building and contents) over \$5,000 each, and the cumulative amount of such claims payments exceeds \$20,000; or
- (b) at least two separate claims payments (building payments only) have been made with the cumulative amount of the building portion of such claims exceeding the market value of the building.

These buildings represent significant losses for the NFIP each year. FEMA is continuing to focus NFIP and retrofitting mitigation efforts on properties that have sustained or are likely to sustain repetitive losses and severe repetitive losses. Possible FEMA funding sources for these activities include:

- Increased Cost of Compliance (ICC) coverage
- Hazard Mitigation Assistance (HMA) grant programs
  - Hazard Mitigation Grant Program (HMGP)
  - Pre-Disaster Mitigation (PDM)
  - Flood Mitigation Assistance (FMA)
  - Repetitive Flood Claims (RFC)
  - Severe Repetitive Loss (SRL)

See Appendix A for additional information on these sources of funding. For more information on FEMA and non-FEMA sources of funding, readers are encouraged to contact their State NFIP and HMGP Coordinators or State Hazard Mitigation Officers.

## 2.1.1 Flood Hazard Information

The requirements of the NFIP are based on the BFE, which is the flood level that has a 1-percent chance of being equaled or exceeded in any given year. The associated flood is called the base flood event. Communities that participate in the NFIP's Regular Program typically have a detailed Flood Insurance Study (FIS), which presents flood elevations of varying frequency, including the base flood, areas inundated by the various magnitudes of flooding, and floodway boundaries. This information is presented on a Flood Insurance Rate Map (FIRM). Retrofitting designers may use data from FIRMs and FIS reports to determine floodplain limits, flood depth, flood elevation, and flood frequency.



### WARNING

FIRMs use the North American Vertical Datum (NAVD) of 1988. Older FIRMs may use National Geodetic Vertical Datum (NGVD) of 1929. Communities normally use NAVD 88 for surveying purposes; if the community's FIRM uses NGVD 29, then NGVD 29 must be used for all elevations on FEMA Elevation Certificates and other NFIP applications.

### 2.1.1.1 Flood Insurance Rate Maps

A FIRM is the official map of an NFIP community that delineates the SFHAs and the risk premium zones applicable to the community. FIRMs are developed based on detailed study and analysis, including historic,

meteorological, hydrologic, and hydraulic data. Communities and homeowners can use the FIRM to locate properties and buildings in flood insurance risk areas. FIRMs can be obtained through a community's floodplain manager, or online at the FEMA Map Service Center (MSC) (<http://www.msc.fema.gov/>). For more instruction on reading a FIRM, view the FIRM tutorial course ([http://www.fema.gov/plan/prevent/fhm/ot\\_firmr.shtm](http://www.fema.gov/plan/prevent/fhm/ot_firmr.shtm)). Digitized FIRMs are also known as digital FIRMs (DFIRMs). Beginning on or after October 1, 2009, FEMA will provide a single paper flood map and FIS to each mapped community. FEMA will convert all other distribution of maps and FIS reports for digital delivery.

A FIRM generally shows areas inundated during the base flood as either Zone A or Zone V. An example of a DFIRM for riverine flooding is shown in Figure 2-1; a DFIRM for coastal flooding is shown in Figure 2-2.

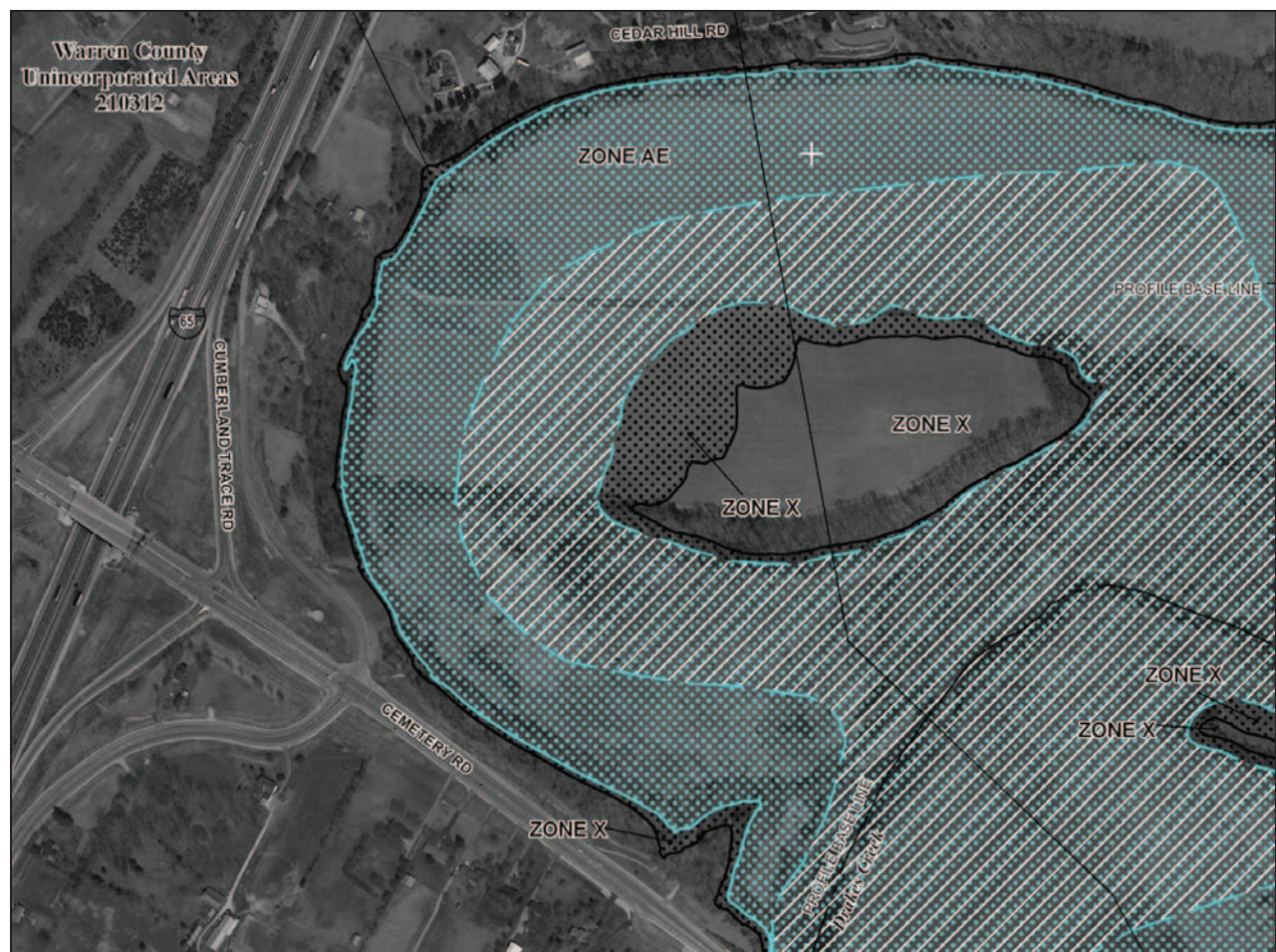

Figure 2-1. Typical DFIRM for riverine flooding

The insurance zone designations shown on FIRMs indicate the severity or type of flooding in the area. Areas of moderate to low risk include:

- **Zone X (shaded) and Zone B:** Areas of moderate flood hazard, usually depicted on FIRMs as between the limits of the base and 0.2-percent-annual-chance floods (also called the 500-year flood). These zones





Figure 2-2. Typical DFIRM for coastal flooding showing the Limit of Moderate Wave Action (LimWA)

are also used to designate base floodplains with low risk of hazards, such as those with average depths of less than 1 foot or drainage areas less than 1 square mile, and areas protected by levees from the base flood. Zone B is used on older FIRMs;

- **Zone X (unshaded) and Zone C:** Areas of minimal flood hazard, usually depicted on FIRMs as above the 0.2-percent-annual-chance flood level. These zones may have flooding that does not meet the criteria to be mapped as a SFHA, such as ponding and local drainage problems. Zone C is used on older FIRMs; and
- **Zone D:** Areas of undetermined, but possible flood hazards.
- **Zone A:** The SFHA subject to inundation by the 1-percent-annual-chance flood event (except Zone V) mapped on a community's FIRM. The six types of Zone A are:
  - **A:** Determined using approximate methodologies where no BFE or flood depths are shown;
  - **AE and A1-A30:** Determined using detailed methodologies where the FIRM shows a BFE. Zone AE delineations are used on newer FIRMs instead of numbered zones;
  - **AH:** Shallow flooding (usually areas of ponding) where average depths are between 1 and 3 feet. BFEs derived from detailed analysis are shown;

- **AO:** Shallow flooding (usually sheet flow on sloping terrain) where average depths are between 1 and 3 feet. Average flood depths derived from detailed analysis are shown. Some Zone AOs have been designated in areas with high flood velocities, such as alluvial fans and washes;
- **AR:** Areas that result from the decertification of a previously accredited flood protection system that is determined to be in the process of being restored to provide base flood protection; and
- **A99:** Areas subject to the 1-percent-annual-chance flood event, but which will ultimately be protected upon completion of an under-construction Federal flood protection system. No BFEs or depths are shown. Zone A99 may only be used when the flood protection system has reached specified statutory progress toward completion.

Starting in 2008, FEMA began mapping the LiMWA in coastal areas. The LiMWA represents the landward limit of the 1.5-foot wave (see Figure 2-2). The area between the LiMWA and the Zone V limit is known as the Moderate Wave Action (MoWA) area in flood maps, and the Coastal A Zone for building code and standard purposes (such as in ASCE 24, *Flood Resistant Design and Construction*). This area is subject to wave heights between 1.5 and 3 feet during the base flood. The area between the LiMWA and the landward limit of Zone A due to coastal flooding is known as the Minimal Wave Action (MiWA) area, and is subject to wave heights less than 1.5 feet during the base flood.



### NOTE

There presently are no NFIP floodplain management requirements or special insurance ratings associated with the designation of the LiMWA. However, in areas designated with a LiMWA, communities are encouraged to adopt Zone V requirements rather than the minimum NFIP requirements in MoWA areas to address the increased risks associated with waves and velocity action.

- **Zone V:** The Coastal High Hazard Area subject to inundation by the 1-percent-annual-chance flood event and high-velocity wave action. There are two types of Zone V, which correspond to the Zone A designations based on the level of detailed analysis used:
  - **V:** No BFEs or flood depths are shown; and
  - **VE and V1-30:** The FIRM shows a BFE. Zone VE delineations are used on newer FIRMs instead of numbered zones.

ASCE 24 warns that even the latest FIRMs and FISs may be based on limited or incomplete information and suggests that the community should always be contacted to obtain the latest information. Designers should not determine a zone designation from a FIRM with a higher degree of precision than intended. Several aspects of flood hazards and mapping should be considered: (1) the determination of flood hazard areas and maps involves detailed analysis, but also assumptions and judgment made by modelers; (2) the base flood is a statement of probability; (3) changes in land use over time contribute to increases in flood elevations in riverine areas; (4) coastal flood mapping is sensitive to topography, which may change over time due to erosion and development; (5) base maps do not include sufficient scale to capture all ground elevations; and (6) the scale of most FIRMs is such that the width of the lines delineating zones can be a factor in determining whether a structure is in or out of a certain flood zone.

### 2.1.1.2 Flood Insurance Studies

FIRMs are based on the information provided in an FIS. An FIS is based on detailed engineering studies. In addition to providing detailed information on the hydrology and hydraulics of the community, the FIS provides a narrative of the community's flood history and sources of flooding. FISs show discharges and flood profiles for riverine floodplains, and stillwater elevations and wave height transects for coastal floodplains. FISs can be obtained through a community's floodplain manager, or online at the FEMA Map Service Center (<http://www.msc.fema.gov/>). For more instruction on reading an FIS, view the FIS tutorial course ([http://www.fema.gov/plan/prevent/fhm/ot\\_fisr.shtm](http://www.fema.gov/plan/prevent/fhm/ot_fisr.shtm)).

**Riverine Floodplains:** An FIS for riverine floodplains describes in detail how the flood hazard information – including floodways, discharges, velocities, and flood profiles for major riverine areas – was developed for each community.

The area of the 100-year riverine floodplain is often divided into a floodway and a floodway fringe. The floodway is the channel of a watercourse plus any adjacent floodplain areas that must be kept free of encroachment so that the cumulative effect of the proposed encroachment, when combined with all other existing or proposed encroachments, will not increase the BFE more than 1 foot at any point within the community.

The area between the floodway and 100-year floodplain boundaries is termed the floodway fringe. The floodway fringe encompasses the portion of the floodplain that could be completely obstructed without increasing the water-surface elevation of the base flood by more than 1 foot at any point. Many States and communities limit the allowable increase to less than 1 foot. Figure 2-3 shows a typical riverine floodplain cross section, including the floodway and floodway fringe.

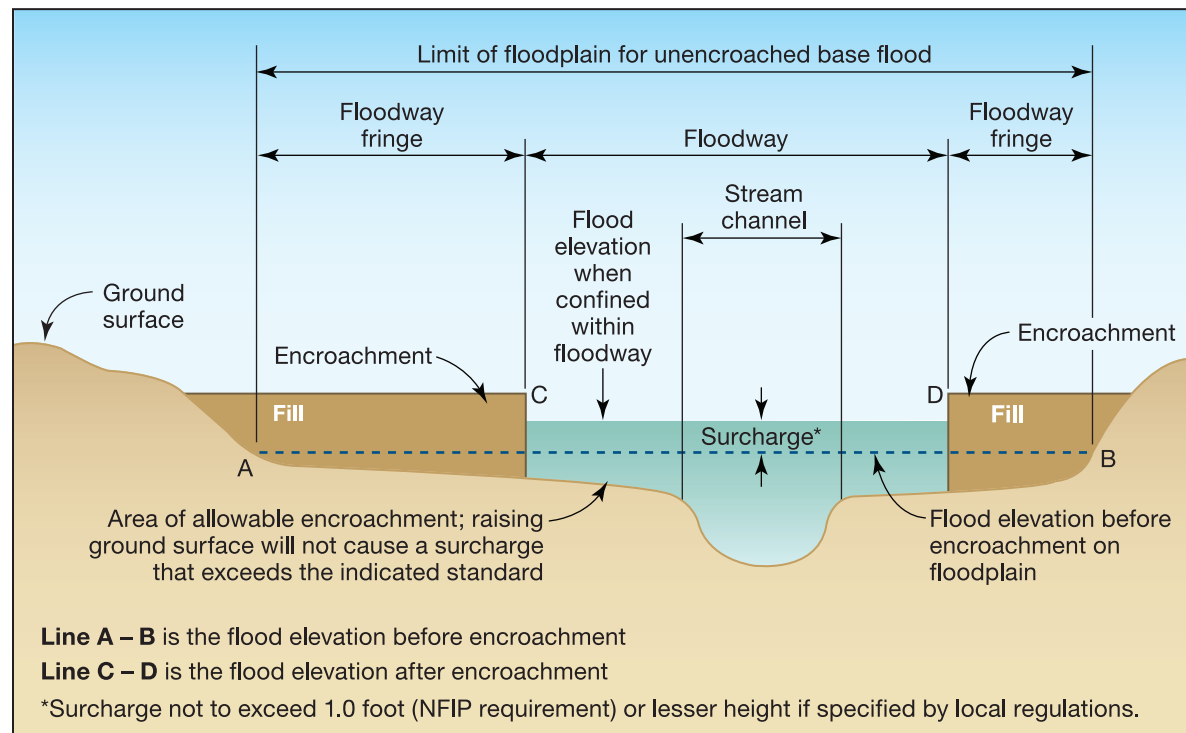

Figure 2-3. Typical riverine floodplain cross section



Discharges are determined for various locations and flood frequencies along the stream and are presented in a summary table in the FIS report. Flood profiles depict various flood frequency and channel bottom elevations along each studied stream. For most streams with significant flood hazards, the FIS for riverine floodplains normally contains discharges and water-surface elevations for the 10-, 50-, 100-, and 500-year floods, which have annual exceedance probabilities of 10, 2, 1, and 0.2 percent, respectively.

**Coastal Floodplains:** In coastal communities that contain both riverine and coastal floodplains, the FIS may contain information on both coastal and riverine hazards. The coastal analysis includes the determination of the storm surge stillwater elevations for the 10-, 2-, 1-, and 0.2-percent-chance floods (commonly referred to as the 10-, 50-, 100-, and 500- year floods, respectively) as shown in Table 4-2.

These stillwater elevations represent the potential flood elevations from tropical storms (hurricanes and typhoons), extra-tropical storms (nor'easters), tsunamis, or a combination of any of these events. The FIS wave analysis includes an estimate of the expected beach and dune erosion during the base flood and the increased flood hazards from wave heights and wave runup.

The increases from wave heights and runup are added to the stillwater elevations to yield the regulatory BFE. Figure 2-4 illustrates the wave height transect showing the effects of physical features on the wave heights and corresponding BFE.



**CROSS REFERENCE**

The example in Chapter 4 includes an example of a Summary of Discharges Table and Riverine Flood Profile.



**NOTE**

This manual does not cover design issues in Coastal High Hazard Areas (Zone V). For information on coastal design and construction, refer to FEMA's *Coastal Construction Manual* (FEMA P-55, Fourth Edition, 2011).



**CROSS REFERENCE**

The example in Chapter 4 includes an example of a Summary of Coastal Stillwater Elevations Table.

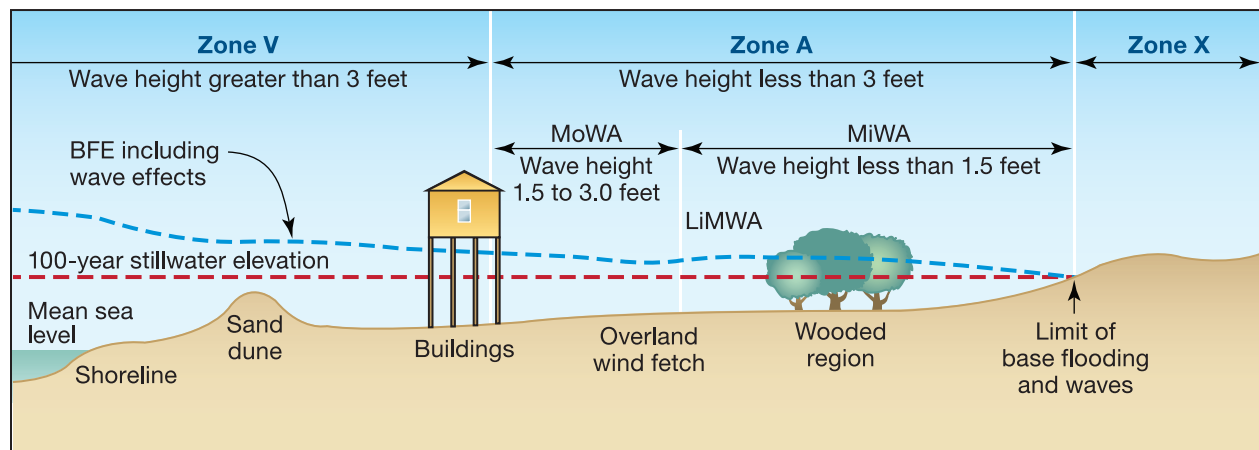

Figure 2-4. Wave height transect showing LimWA, MoWA, and MiWA

## 2.1.2 Floodplain Management Regulations

The floodplain management aspects of the NFIP are implemented by communities. A “community” is a governmental body with the statutory authority to enact and enforce development regulations. The authority of each unit of government varies by State. Eligible communities can include cities, villages, towns, townships, counties, parishes, States, and Indian Tribes. Over 21,000 communities participate in the NFIP.

To participate in the NFIP, communities must, at a minimum, regulate development in their floodplains in accordance with the NFIP criteria and State regulations. To do this, communities must require a permit before any development in the regulatory floodplain proceeds. Before the permit is issued, the community must ensure that two basic criteria are met:

- all new construction, substantial improvements, and repairs of substantial damage will be protected from damage by the base flood; and
- new floodplain development will not aggravate existing flood problems or increase damage to other properties.

Several definitions are needed to guide the designer through floodplain management regulations. The NFIP definitions of key terms are provided below.

**Basement:** Any area of the building having its floor subgrade (below ground level) on all sides.

**Enclosure:** That portion of an elevated building below the lowest elevated floor that is either partially or fully shut in by rigid walls.

**Lowest Floor:** The lowest floor of the lowest enclosed area (including basement). An unfinished or flood-resistant enclosure, usable solely for parking of vehicles, building access, or storage in an area other than a basement area is not considered a building’s lowest floor, provided that such enclosure is not built so as to render the structure in violation of the applicable non-elevation design requirement of 44 CFR 60.3.

**Post-FIRM:** A post-FIRM building (for floodplain management purposes) is a building for which the start of construction post-dates the effective date of the community’s NFIP-compliant floodplain management ordinance.



### CROSS REFERENCE

FEMA has developed two resources to assist State and local officials with NFIP requirements for substantially improved/substantially damaged buildings. The *Substantial Improvement/ Substantial Damage Desk Reference* (FEMA P-758, 2010c) provides practical guidance and suggested procedures to implement the NFIP requirements for substantially improved or substantially damaged buildings.

*The Substantial Damage Estimator* (FEMA P-784, 2010d) software assists State and local officials in determining substantial damage using data collected during the evaluation process.



### NOTE

The definitions of pre-FIRM and post-FIRM are different for insurance and floodplain management purposes. See Section 2.1.3 for the insurance definitions.

**Pre-FIRM:** A pre-FIRM building (for floodplain management purposes) is a building for which the start of construction occurred before the effective date of the community's NFIP-compliant floodplain management ordinance.

**Structure:** For floodplain management purposes, a walled and roofed building, including a gas or liquid storage tank, that is principally above ground, as well as a manufactured home.

**Substantial Damage:** Damage of any origin sustained by a structure whereby the cost of restoring the structure to its before-damaged condition would equal or exceed 50 percent of the market value of the structure before the damage occurred.

**Substantial Improvement:** Any reconstruction, rehabilitation, addition, or other improvement of a structure, the cost of which equals or exceeds 50 percent of the market value of the structure before the "start of construction" of the improvement. This term includes structures which have incurred "substantial damage," regardless of the actual repair work performed. The term does not, however, include either:

1. any project for improvement of a structure to correct existing violations of State or local health, sanitary, or safety code specifications which have been identified by the local code enforcement official and which are the minimum necessary to assure safe living conditions, or
2. any alteration of a "historic structure," provided that the alteration will not preclude the structure's continued designation as a "historic structure."

Under NFIP criteria, all new (post-FIRM) construction related to substantially improved or substantially damaged residential structures located within Zones A1-A30, AE, and AH must have the lowest floor at or above the BFE. Therefore, elevation and relocation are the retrofitting alternatives that enable a post-FIRM or a substantially improved or substantially damaged structure to be brought into compliance with the NFIP.

Utilizing the aforementioned definitions and local codes, the designer can begin to determine which retrofitting measures may be acceptable for each specific home.

### 2.1.3 Insurance Program

Federally-backed flood insurance is made available in communities that agree to implement NFIP-compliant floodplain management programs that regulate future floodplain development. Communities apply to participate in the program in order to make flood insurance and certain forms of Federal disaster assistance available in their community.

Everyone in a participating community can purchase flood insurance coverage, even for properties not located in mapped floodplains. Insurance provides relief for all floods, including those that are not big enough to warrant Federal disaster aid, as long as a general condition of flooding exists.

The Federal Government makes flood insurance available only in communities that adopt and enforce floodplain management regulations that meet or exceed NFIP criteria. Because the communities will ensure that future development will be resistant to flood damage, the Federal Government is willing to support insurance and help make it affordable.

The Flood Disaster Protection Act of 1973 expanded the program to require flood insurance coverage as a condition of Federal aid or loans from federally-insured banks and savings and loans institutions for buildings



located in identified flood hazard areas. Most communities joined the NFIP after 1973 in order to make this assistance available for their flood-prone properties.

NFIP flood insurance is available through many private flood insurance companies and independent agents, as well as directly from the Federal Government. All companies offer identical coverage and rates as prescribed by the NFIP.

For flood insurance rating purposes, residential buildings are classified as being either pre-FIRM or post-FIRM. Pre-FIRM construction is defined as construction or substantial improvement begun on or before December 31, 1974, or before the effective date of the community's initial FIRM, whichever is later. Post-FIRM construction includes construction or substantial improvement that began after December 31, 1974, or on or after the effective date of the community's initial FIRM, whichever is later.

Insurance rates for pre-FIRM buildings are set on a subsidized basis; while insurance rates for post-FIRM structures are set actuarially on the basis of designated flood hazard zones on the community's FIRM and the elevation of the lowest floor of the building in relation to the BFE. This rate structure provides owners an incentive to elevate buildings in exchange for receiving the financial benefits of lower insurance rates. Subsequent to substantial improvements, a pre-FIRM building will become a post-FIRM building for flood insurance rating purposes. Only elevation or relocation techniques may result in reduced flood insurance premiums or in eliminating the need for flood insurance.

To provide incentives for communities to adopt more stringent requirements, FEMA established the NFIP Community Rating System. For more information about the CRS, contact the NFIP Coordinating Agency for your State or the appropriate FEMA Regional Office. See also FEMA's CRS Web site (<http://www.fema.gov/business/nfip/crs.shtm>), which includes basic information and links to other CRS resources, including the CRS Resource Center (<http://training.fema.gov/EMIWeb/CRS/>).

## 2.1.4 NFIP Flood-Prone Building Performance Requirements

The NFIP has established minimum criteria and design performance requirements that communities participating in the NFIP must enforce for structures located in SFHAs. These criteria specify how a structure should be constructed in order to minimize or eliminate the potential for flood damage. Table 2-1 summarizes some of the key requirements of the NFIP for new construction, substantially improved, and substantially damaged buildings in Zone A.

FEMA, the USACE, the NRCS, and several State and local government entities have developed technical guidance manuals and information for public distribution to assist in the application of these requirements by the building community (i.e., building code and zoning officials, engineers, architects, builders, developers, and the general public). These resources (listed in Appendix F) contain guidelines for the use of certain techniques and materials for design and construction that meet the intent of the NFIP's general design criteria. These publications also contain information on the generally accepted practices for flood-resistant design and construction.



### CROSS REFERENCE

For more information on NFIP requirements and recommendations to exceed those requirements, see Appendix G of this Manual. Appendix G includes information for Zone A, Coastal A Zone, and Zone V.

Table 2-1. Summary of Key NFIP Requirements for Zone A

Provision	Requirement
<b>Design and Construction</b> 44 CFR 60.3(a)(3)(i)	Building and foundation must be designed, constructed, and adequately anchored to prevent flotation, collapse, and lateral movement resulting from hydrodynamic and hydrostatic loads, including the effects of buoyancy.
<b>Lowest Floor Elevation</b> 44 CFR 60.3(c)(2)	Top of lowest floor must be at or above BFE.
<b>Flood Damage-Resistant Materials</b> 44 CFR 60.3(a)(3)(ii)	Structural and nonstructural building materials below the BFE must be flood damage-resistant.
<b>Enclosures</b> 44 CFR 60.3(c)(5)	Use of enclosures is restricted to parking of vehicles, building access, and storage. Walls of enclosures must have a minimum of two flood openings to allow passage of flood waters.
<b>Utilities</b> 44 CFR 60.3(a)(3)(iv)	Utilities and equipment must be located (elevated) at or above the BFE or designed to prevent flood waters from entering and accumulating in components during flooding.

FEMA has also been involved in a multi-year effort to incorporate the NFIP flood-damage-resistant design standards into the nation’s model building codes and standards, which are then adopted by either States or communities. This effort has resulted in the inclusion of the standards in the International Building Code Series (I-Codes) published by the International Code Council and in ASCE 7, *Minimum Design Loads for Buildings and Other Structures* (ASCE, 2010) and ASCE 24, *Flood Resistant Design and Construction* (ASCE, 2005).

## 2.2 Community Regulations and the Permitting Process

Regulation of the use of floodplain lands is a responsibility of State and local governments and, in limited applications, the Federal Government (wetlands, navigable waterways, Federal lands, etc.). It can be accomplished by a variety of procedures, such as establishment of designated floodways and encroachment lines, zoning ordinances, subdivision regulations, special use permits, floodplain ordinances, and building codes. These land-use controls are intended to reduce or eliminate flood damage by guiding and regulating floodplain development.



### TERMINOLOGY: FLOODWAY

The floodway is the channel of a river or other watercourse and the adjacent land areas that must be reserved in order to discharge the base flood without cumulatively increasing the water surface elevation more than a designated height.

As was explained in Chapter 1, flood-prone communities that participate in the NFIP are required to adopt and enforce, at a minimum, NFIP-compliant floodplain regulations to qualify for many forms of Federal disaster assistance and for the availability of flood insurance. State and local floodplain ordinances are essentially the NFIP requirements with additional requirements set by the State or community. Many States and communities have more restrictive requirements than those established by the NFIP. In fact, State and community officials, using

knowledge of local conditions and in the interest of safety, may set higher standards, the most common of which are listed below.

- Freeboard means a factor of safety usually expressed in feet above a flood level for purposes of flood plain management. Freeboard tends to compensate for the many unknown factors that could contribute to flood heights greater than the height calculated for a selected size flood and floodway conditions, such as wave action, bridge openings, and the hydrological effect of urbanization of the watershed.
- Restrictive standards prohibit building in certain areas, such as the floodplain, conservation zones, and the floodway.
- The use of building materials and practices that have previously proven ineffective during flooding may be prohibited.
- The use and type of construction fill material may be further restricted by the higher standards adopted by some States and communities.

Before committing a significant investment of time and money in retrofitting, the design professional should contact the local building official for building code and floodplain management requirements and information on obtaining necessary permits. The ultimate decision on the application of building codes and floodplain requirements lies with the local building code official. When obtaining a permit and doing construction, the local building official or floodplain manager may add to the scope of work proposed by the homeowner in order to bring the retrofit project into compliance with applicable codes, standards, and regulations.

## 2.3 National Model Building Codes

The National Model Building Codes currently include the I-Codes and the National Fire Protection Association (NFPA) *Building Construction Safety Code* (NFPA 5000, 2009). The I-Codes have been widely adopted and used by local communities (in whole or in part with amendments). The I-Codes include a comprehensive set of requirements for building systems that meet or exceed the minimum NFIP requirements for flood-resistant design and construction requirements of the building types and systems for which they are written. The I-Codes include:

- IBC Appendix G addresses other NFIP requirements such as floodplain management issues;
- *The International Residential Code (IRC) for One- and Two-Family Dwellings*;
- *The International Existing Building Code (IEBC)*;



### WARNING

The adoption and enforcement of building codes and standards is not consistent across the United States. Codes and standards in some States and communities may be more restrictive than those in others. In addition, some communities have not adopted a building code. In communities where building codes have not been adopted or where the existing codes are not applied to one- and two-family residential buildings, design professionals, contractors, and others engaged in the design and construction of residential buildings are encouraged to follow the requirements of a model building code.

Some States, local governments, and communities, however, make their own amendments to the national model building codes. In these cases, it may be unclear if the adopted code is still consistent with NFIP floodplain management regulations.

- *The International Plumbing Code (IPC)*;
- *The International Mechanical Code (IMC)*;
- *The International Fuel Gas Code (IFGC)*;
- *The International Private Sewage Disposal Code (IPSDC)*; and
- *The International Fire Code (IFC)*

The NFPA 5000 addresses construction, protection, and occupancy, and is consistent with the flood-resistant design requirements of the NFIP.

At the time of this revision, 47 percent of floodprone communities have adopted a flood-resistant building code that meets or exceeds NFIP requirements (ISO 2011). Prior to the availability of the 2000 I-Codes, most communities adopted stand-alone floodplain management regulations. With the I-Codes, it is possible to integrate building codes and floodplain management into a single administrative process. In order to participate in the NFIP using this approach, all of the IBC, including Appendix G, must be adopted. Otherwise, not all “development,” as defined by the NFIP, is regulated adequately. If Appendix G is not adopted, then provisions regulating “development” would need to be included in a stand-alone ordinance. The IRC includes flood-resistant construction requirements as part of the code and thus are adopted when the IRC is adopted. For more information about the IBC adoption process, contact the State or local building and permitting officials.

### 2.4 Consensus Standards

Numerous standards related to design and construction practices and construction materials are incorporated into a building code by reference rather than by inclusion of all of the text of the standard in the code. ASCE, with FEMA’s assistance, worked to develop flood loads for inclusion in ASCE 7 and ASCE 24. These standards were developed by a committee of nationally recognized experts following the consensus standards process. Relevant consensus standards include:

- American Concrete Institute (ACI) 530, *Building Code Requirements for Masonry Structures*. ACI 530 is a referenced standard in the IBC and IRC;
- ASCE 7, *Minimum Design Loads for Buildings and Other Structures*. ASCE 7 is a referenced standard in the IBC, IRC, and NFPA 5000; and
- ASCE 24, *Flood-Resistant Design and Construction*. ASCE 24 is a referenced standard in the IBC and NFPA. The IRC allows, but does not require, the design provisions of ASCE 24.

ASCE 24 specifies minimum requirements for flood-resistant design and construction of structures located in flood hazard areas. The basic design requirements that are addressed in ASCE 24 include flood loads, load combinations, elevation of the lowest floor, foundation requirements, materials, wet and dry floodproofing, utility installations, and building access. In addition, ASCE 24 includes specifications for the design of pile, post, pier, column, and shear wall foundations.

The requirements of codes and standards meet or exceed the minimum NFIP requirements. Appendix G of this publication provides a summary of selected key NFIP provisions and recommended best practices for exceeding the requirements. It cross-references the I-Codes and the ASCE consensus standards.





# 3 Parameters of Retrofitting

In this chapter, the factors that influence retrofitting decisions are examined and compared with various methods to determine the viability of specific retrofitting techniques. These factors include:

- homeowner preferences;
- community regulations and permitting requirements; and
- technical parameters.

Factors such as homeowner preference and technical parameters are key elements in identifying appropriate retrofitting measures, while consideration of the multiple flood-related and non-flood-related hazards is critical in designing the retrofitting measure and/or avoiding the selection of a poor retrofitting method.

This selection of alternatives can be streamlined through the use of two generic retrofitting matrices, which are designed to help the designer narrow the range of floodproofing options:

- **Preliminary Floodproofing/Retrofitting Preference Matrix** (Figure 3-1), which focuses on factors that influence homeowner preference and those measures allowable under local regulations.
- **Retrofitting Screening Matrix** (Figure 3-3), which focuses on the objective physical factors that influence the selection of appropriate retrofitting techniques.



## 3.1 Determination of Homeowner Preferences

The proper evaluation of retrofitting parameters will require a series of homeowner coordination and design input meetings. Ultimately, the homeowner will have to deal with the flood protection environment on a daily basis. Therefore, the functional and cosmetic aspects of the retrofitting measure, such as access, egress, landscaping, appearance, etc., need to be developed by including the homeowner's thoughts and ideas. Most retrofitting measures are permanent and should be considered similar to a major home addition or renovation project. The design should incorporate the concepts of those who will be using the retrofitted structure.

Issues that should be addressed include:

- retrofitting aesthetics;
- economic considerations;
- risk considerations;
- accessibility;
- local code requirements;
- building mechanical/electrical/plumbing system upgrades; and
- off-site flooding impacts.



### NOTE

In order to avoid any future misunderstandings, designers should use their skills and knowledge of retrofitting projects to address technical implications while working with homeowners. Many owners have little or no technical knowledge of retrofitting and naturally look to the designer or local official for guidance and expert advice.

The Preliminary Floodproofing/Retrofitting Preference Matrix (Figure 3-1) assists the designer in documenting the initial consultation with the homeowner. The first consideration, Measure Allowed [by community] or Owner Requirement, enables the designer to screen alternatives that are not permissible and must be eliminated from further consideration. Discussion of the considerations for the remaining measures should lead to a “no” or “yes” for each of the boxes (see the instructions under Figure 3-1 for instructions to fill out the matrix). Examination of the responses will help the homeowner and designer select retrofitting measures for further examination that are both viable and preferable to the owner. If a “no” or “yes” cannot be determined, then more research may be required. In some cases, conservative assumptions should be made and later revisited to keep the process moving forward.

### 3.1.1 The Initial Homeowner Meeting

The first step in the homeowner coordination effort is the educational process for both the designer and the property owner. This step is a very important one.

The homeowner learns:

- how it was determined that the home is in the floodplain;
- possible impacts of an actual flood;
- benefits of flood insurance;



### NOTE

The evaluation of information obtained during the initial meeting with the homeowner will help the designer and owner address the flood threat to the entire structure and the vulnerability of specific openings to floodwater intrusion.



Preliminary Floodproofing/Retrofitting Preference Matrix									
Owner Name: _____ Prepared By: _____					Address: _____ Date: _____				
Property Location: _____									
Floodproofing Measures									
Considerations									
	Elevation on Foundation Walls	Elevation on Fill	Elevation on Piers	Elevation on Posts and Columns	Elevation on Piles	Relocation	Dry Flood-proofing	Wet Flood-proofing	Floodwalls and Levees
Note the measures NOT allowed									
Homeowner Concerns									
Aesthetic Concerns									
High Cost Concerns									
Risk Concerns									
Accessibility Concerns									
Code Required Upgrade Concerns									
Off-Site Flooding Concerns									
Total "x's"									

Instructions: Determine whether or not floodproofing measure is allowed under local regulations or homeowner requirement. **Put an "x" in the box for each measure which is not allowed.**

Complete the matrix for only those measures that are allowable (no "x" in the first row). For those measures allowable or owner required, evaluate the considerations to determine if the homeowner has concerns that would affect its implementation. A concern is defined as a homeowner issue that, if unresolved, would make the retrofitting method(s) infeasible. If the homeowner has a concern, place an "x" in the box under the appropriate measure/consideration. Total the number of "x's". The floodproofing measure with the least number of "x's" is the most preferred.

Figure 3-1. Preliminary Floodproofing/Retrofitting Preference Matrix

- physical, economic, and risk considerations; and
- what to expect during each step in the retrofitting process.

The designer learns:

- flood history of the structure;
- homeowner preferences;
- financial considerations;
- special issues, such as accessibility requirements for the disabled; and
- information about the subject property such as:
  - topographic surveys;
  - site utility information; and
  - critical home dimensions.

During this initial meeting, the homeowner and designer should jointly conduct a preliminary assessment of the property to determine which portions of the structure require flood protection and the general condition of the structure. This initial evaluation will identify the elevation of the lowest floor and the elevation of potential openings throughout the structure through which floodwater may enter the residence.

#### 3.1.2 Initial Site Visit

A low point of entry determination, illustrated in Figure 3-2, identifies the elevation of the lowest floor and each of the structure's openings. and may include:

- lowest floor or basement slab;
- windows, doors, and vents;
- mechanical/electrical equipment and vents;
- drains and other floor penetrations; and
- water spigots, sump pump discharges, and other wall penetrations.

In addition to the lowest floor and structure openings, the following points should also be identified or established during the initial site visit:

- finished floor elevation of the structure (unless already identified as lowest floor);
- other site provisions that may require flood protection, such as storage sheds, wellheads, and storage tanks; and
- an elevation reference mark on or near the house.



#### NOTE

Sometimes it is necessary for a field survey to be conducted by a professional land surveyor before design documents are developed. However, frequently the homeowner and designer may be able to develop a rough elevation relationship between the expected flood elevation, the elevation of the lowest floor, and the low points of entry to the structure sufficient for an initial evaluation.

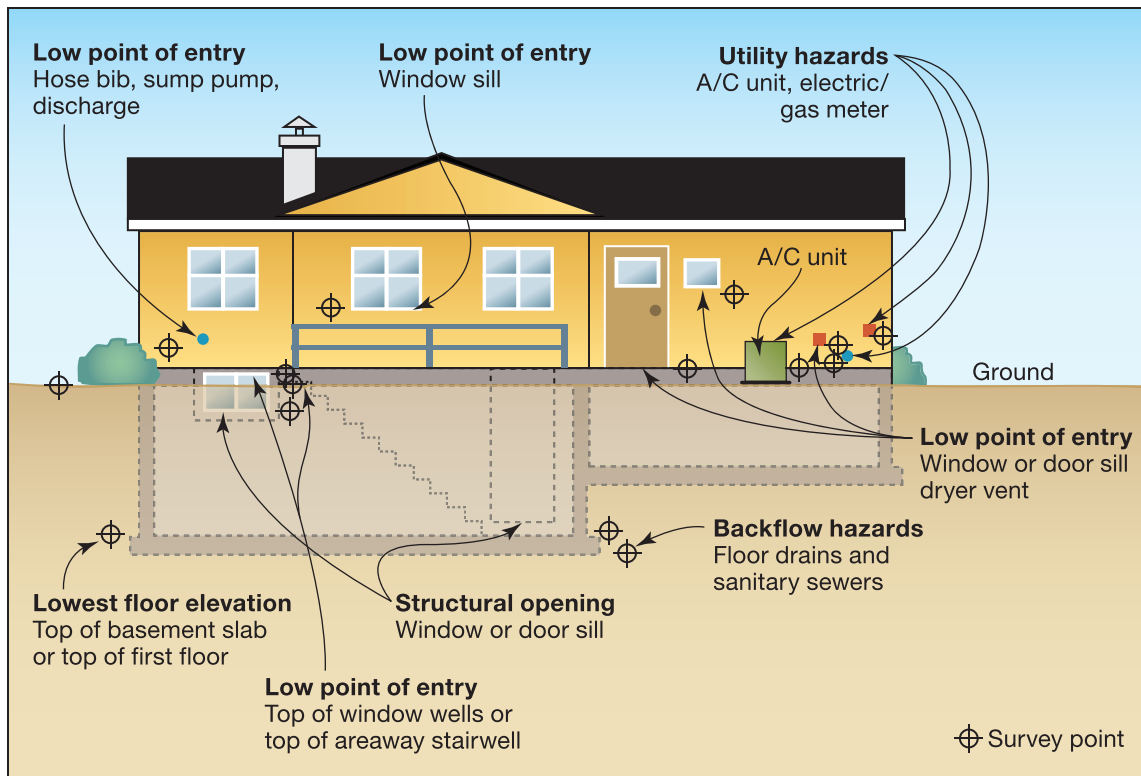

Figure 3-2. Survey to identify the low point of floodwater entry into a typical residential structure

Once the low point of entry determination has been completed, the homeowner and designer can determine the DFE and/or identify openings that need to be protected (as in the case of dry floodproofing in non-residential buildings).

The approximate height of the retrofitting measure can be used by the homeowner and designer as they evaluate each of the parameters of retrofitting discussed in this chapter. In addition to determining the low point of entry, this initial site visit should be used to assess the general overall condition of the structure.

### 3.1.3 Aesthetic Concerns

Although physical and economic considerations may help determine feasible retrofitting measures for individual buildings, the homeowner may consider other factors equally or more important. Aesthetics, for example, is a subjective issue.

The homeowner may reject a measure that scores high for all considerations except aesthetics. On the other hand, what may be aesthetically pleasing to the homeowner may not be technically appropriate for a project. Here, a designer must use skill and experience to achieve a common ground. In doing so, the homeowner's preference should be considered, while not jeopardizing the structural, functional, and overall success of the proposed project.

An aesthetically pleasing solution that also performs well as a retrofitting alternative can be achieved through an understanding of the relationship between the existing and proposed modifications, creative treatment and modification of surrounding landforms, proper landscaping techniques, and preservation of essential and scenic views.

### 3.1.4 Economic Considerations

At this point, the designer should not attempt to conduct a detailed cost analysis. Rather, general estimates of the cost of various retrofitting measures should be presented to the homeowner.



**NOTE**

In relocating a structure, the cost of preparing the new site and cleaning up the old site must be considered.

As discussed in Chapter 1, the cost of retrofitting will depend on a variety of factors, including the building’s condition, the retrofitting measure to be employed, the DFE, the choice of materials and their local availability, the availability and limitations of local labor, and other site-specific issues (i.e., soil conditions and flooding levels) and other hazards.

The costs in Tables 3-1 through 3-4 are provided to assist in economic analysis and preliminary planning purposes. Table 3-5 provides a comparison of relative costs and risks across all floodproofing methods.

Additional costs that may be incurred:

- temporary living quarters (displacement costs) that may be necessary during construction (estimate: relocation: 3 to 4 weeks; elevation: 2 to 3 weeks);
- professional or architectural design (10 percent of the costs of selected retrofitting measures);
- contractors’ profit (10 percent of the estimated costs); and
- contingency to account for unknown or unusual conditions.

**Table 3-1. Relative Costs of Elevating a Home**

Construction Type	Existing Foundation	Retrofit	Relative Cost
Frame	Basement, crawlspace, or open foundation	Elevate on continuous foundation walls or open foundation	Lowest Highest
Frame with masonry veneer		Elevate on continuous foundation walls or open foundation	
Loadbearing masonry		Extend existing walls and create new elevated living area	
Frame	Slab-on-grade	Elevate on continuous foundation walls or open foundation	
Frame with masonry veneer		Elevate on continuous foundation walls or open foundation	
Loadbearing masonry		Elevate on continuous foundation walls or open foundation	

Table 3-2. Relative Costs of Relocation

Construction Type	Existing Foundation	Retrofit	Relative Cost
Frame	Crawlspace or open foundation	Relocate existing home and install the home on a new foundation at the new site, hook up utilities, and restore the old site	Lowest  Highest
Frame with masonry veneer			
Loadbearing masonry			
Frame	Basement		
Frame with masonry veneer			
Loadbearing masonry			
Frame	Slab-on-grade		
Frame with masonry veneer			
Loadbearing masonry			



**WARNING**

The relative relocation costs shown here are based on a small home. Because relocation costs do not increase proportionally with the size of a home, the cost per square foot of moving a larger home may be less than that shown here.

Table 3-3. Relative Costs of Floodwalls and Levees

Construction Type	Existing Foundation	Retrofit	Relative Cost
Frame, frame with masonry veneer, or loadbearing masonry	Crawlspace	Wet floodproof crawlspace to a height of 2 ft to 4 ft above LAG	Lowest  Highest
	Basement	Wet floodproof unfinished basement to a height of 2 ft to 4 ft above the basement floor	
	Basement	Wet floodproof unfinished basement to a height of 8 ft above the basement floor	

LAG = Lowest Adjacent Grade

Table 3-4. Relative Costs of Wet Floodproofing

Construction Type	Existing Foundation	Retrofit	Relative Cost
Frame, frame with masonry veneer, or loadbearing masonry	Crawlspace	Wet floodproof crawlspace to a height of 2 ft to 4 ft above LAG	Lowest  Highest
	Basement	Wet floodproof unfinished basement to a height of 2 ft to 4 ft above the basement floor	
	Basement	Wet floodproof unfinished basement to a height of 8 ft above the basement floor	

LAG = Lowest Adjacent Grade



### 3.1.5 Risk Considerations

Another element that is included in the evaluation of retrofitting measures is the risk associated with a do-nothing approach. Risk can also be established among the various measures by knowing the exceedance probability of floods and the design flood levels for competing measures. Relocation is an example of how retrofitting can eliminate the risk of flood damage. On the other hand, a levee designed to protect against a 10-percent-chance-annual exceedance probability (10-year) flood would have an 88-percent chance of being overtopped during a 20-year period. Such information will assist the homeowner in evaluating the pros and cons of each measure. Table 3-6 provides the probabilities associated with one or more occurrences of a given flood magnitude occurring within a specific number of years.

Table 3-6. Flood Risk

	Recurrence Interval (Years)					
		10	25	50	100	500
Length of Period (Years)	1	10%	4%	2%	1%	0.2%
	10	65%	34%	18%	10%	2%
	20	88%	56%	33%	18%	2%
	25	93%	64%	40%	22%	5%
	30	96%	71%	45%	26%	6%
	50	99+%	87%	64%	39%	10%
	100	99.99+%	98%	87%	63%	18%

The table values represent the probabilities, expressed in percentages, of one or more occurrences of a flood of given magnitude or larger within a specified number of years. Probability ( $P$ ) may be calculated for any given Length of Period ( $n$ ) and Recurrence Interval ( $RI$ ) using the following equation:  $P = \left[ 1 - \left( 1 - \frac{1}{RI} \right)^n \right] \times 100\%$ , where  $RI$  and  $n$  are in years.

Flood probabilities are also useful in evaluating the inconvenience aspects of retrofitting. Reducing cleanup and repairs, lost time from work, and average non-use of a building from once in 2 years to once in 10 years could be a powerful incentive for retrofitting even though other aspects may be less convincing.

### 3.1.6 Accessibility for Individuals with Special Needs

Accessibility for individuals with special needs is an issue that must be addressed primarily on the specific needs of the owner. Many retrofitting measures can create access problems for a house that was previously fully accessible. The Americans with Disabilities Act (ADA) of 1990 and the Fair Housing Amendment Act (FHA) of 1988 and other accessibility codes and regulations do not specifically address private single-family residences, which are the focus of this manual. However, the above-mentioned regulations contain concepts that may be of assistance to a designer representing a property owner with special needs.

It is important for the designer to remember that the term “special needs” does not refer only to someone who uses a wheelchair. Other special needs may include:



#### NOTE

A designer should become familiar with the prevailing conditions, codes, and legal restrictions particular to a building's location.

- limited mobility requiring the use of a walker or cane, which can inhibit safe evacuation;
- a person's limited strength to open doors, climb stairs, install flood shields, or operate other devices; and
- partial or total loss of hearing or sight.

Special considerations such as small elevators may be needed.

Discussion of the above factors with the homeowner and utilization of the Preliminary Floodproofing/Retrofitting Preference Matrix in Figure 3-1 will allow the designer to rank the retrofitting methods by homeowner preference.

## 3.2 Community Regulations and Permitting

### 3.2.1 Local Codes

Most local governments regulate building activities by means of building codes as well as floodplain and zoning ordinances and regulations. With the intent of protecting health and safety, most local codes are fashioned around the model building codes discussed in Chapter 2. The designer should be aware that modifications may be undertaken to make the model codes more responsive to the local conditions and concerns in the area, such as seismic and hurricane activity, extreme cold, or humidity.

Determination of which retrofitting measures are allowed under local regulations is an important step in compiling the Preliminary Floodproofing/Retrofitting Preference Matrix (Figure 3-1). Retrofitting measures not allowed under local regulations will be screened and eliminated from further consideration.

### 3.2.2 Building Systems/Code Upgrades

Other local code requirements must be met by homeowners' building improvements. Most building codes require approval when elevation is considered, especially if structural modification and/or alteration and relocation of utilities and support services are involved.

If more stringent laws have been adopted since a building was constructed, local code restrictions can seriously affect the selection of a retrofitting method because construction may be expected to comply with new building codes.



#### CROSS REFERENCE

Chapter 4 of FEMA P-762, *Local Officials Guide to Coastal Construction* (FEMA, 2009b) provides in-depth coverage of permits and inspections.



#### WARNING

Some communities require that structures undergoing substantial rehabilitation, either because of previous damage or significant improvements/additions, be brought into compliance with current building codes. In addition to floodplain management requirements, these requirements could include items such as the addition of fire alarms, removal of lead water pipes, upgrades in electrical wiring, etc.



### 3.2.3 Off-Site Flooding Impacts

Where a chosen retrofitting measure requires the modification of site elements, a designer shall consider how adjacent properties will be affected.

- Will construction of levees and floodwalls create diversions in the natural drainage patterns?
- Will new runoffs be created that may be detrimental to nearby properties?
- If floodproofing disturbs the existing landscape, will re-grading and re-landscaping undermine adjacent streets and structures?
- Will the measure be unsightly or increase the possibility of sliding and subsidence at a later date?
- If a building is to be relocated to another portion of the current site, or if it is to be elevated, will it encroach on established easements or rights-of-way?
- Will the relocated building infringe on wetland areas or regulated floodplains?



#### NOTE

Addressing off-site impacts and issues is as much a matter of responsible practice and conscience as it is a requirement of most building codes and floodplain management ordinances.



#### WARNING

NFIP, state, and local regulations do not allow construction within a floodway or, in some cases, within a floodplain that would back up and increase flood levels.

These and other questions must be addressed and satisfactorily answered by the homeowner and designer in selecting the most appropriate retrofitting measure. Both must be aware of the liabilities that may be incurred by altering drainage patterns and other large-scale site characteristics. The designer should ensure that any modified runoffs do not cause negative impacts on the surrounding properties. The means necessary to collect, conduct, and dispose of unwanted flood or surface water resulting from retrofitting modifications must be understood and clearly resolved.

## 3.3 Technical Parameters

Once the designer has resolved preliminary retrofitting preference issues with the owner, a more intensive evaluation of the technical parameters is normally conducted, including flooding, site, and building characteristics. Figure 3-4 provides a worksheet that can be used to evaluate which measures are appropriate for individual structures. Instructions for using this matrix are presented in Figure 3-5. The remainder of this chapter provides background information on each of the technical parameters, which will be useful to the designer in completing the worksheet.

### 3 PARAMETERS OF RETROFITTING







Owner Name: _____ Prepared By: _____								
Address: _____ Date: _____								
Property Location: _____								
<b>Measures</b>								
<b>Parameters</b>								
	<b>Elevation on Foundation Walls</b>	<b>Elevation on Fill</b>	<b>Elevation on Piers, Posts, Columns, and Piles</b>	<b>Relocation</b>	<b>Dry Flood-proofing</b>	<b>Wet Flood-proofing</b>	<b>Floodwalls and Levees</b>	
<b>Measures Permitted by Community or Preferred by Homeowner</b>								
<b>Flooding Characteristics</b>	<b>Flood Depth</b>							
	Shallow (<3 ft)							
	Moderate (3 to 6 ft)					N/A		
	Deep (>6 ft)					N/A	N/A	N/A
	<b>Flood Velocity</b>							
	Slow/Moderate (≤5 ft/sec)							
	Fast (>5 ft/sec)	1	1	1			N/A	1
	<b>Flash Flooding</b>							
	Yes (<1 hour)					2	2	2
	No							
<b>Site Characteristics</b>	<b>Ice and Debris Flow</b>							
	Yes	6		4		N/A		4
	No							
	<b>Site Location</b>							
Floodway	5	5	5	5	5	5	5	
Other Zone A								
<b>Building Characteristics</b>	<b>Soil Type</b>							
	Permeable					3		3
	Impermeable							
	<b>Building Foundation</b>							
	Slab-on-Grade							
	Crawlspace					N/A		
Basement		6	6		6			
<b>Building Characteristics</b>	<b>Building Construction (Framing)</b>							
	Concrete or Masonry							
	Wood and Others							
	<b>Building Condition</b>							
	Excellent to Good							
	Fair to Poor	6	6	6	6	6		

Figure 3-4. Retrofitting Screening Matrix

The Retrofitting Screening Matrix (Figure 3-4) is designed to screen and eliminate retrofitting techniques that should not be considered for a specific situation.

Steps to Complete Matrix	
<b>Step 1:</b>	Screen alternatives that are neither permitted nor preferable to the homeowner and are eliminated from further consideration, by inserting N/P (not permitted) in the appropriate box(es) on the Measures Permitted by Community or Preferred by Homeowner row. If an N/P is placed in a column representing a retrofitting measure, that alternative is eliminated from consideration.
<b>Step 2:</b>	Select the appropriate row for each of the characteristics that best reflect the flooding, site, and building characteristics.
<b>Step 3:</b>	Circle the N/A (not advisable) boxes that apply in the rows of characteristics selected. Do not circle any N/A boxes where there is a plan to engineer a solution to address the specific characteristic.
<b>Step 4:</b>	Examine each column representing the different retrofitting measures. If one or more N/A boxes are circled in a column representing a retrofitting measure, that alternative is eliminated from consideration.
<b>Step 5:</b>	The numbers enclosed in the boxes represent special considerations (detailed below) that must be accounted for to make the measure applicable. If the consideration cannot be addressed, the number should be circled and the measure eliminated from consideration.
<b>Step 6:</b>	Retrofitting measures that remain should be further evaluated for technical, benefit-cost, and other considerations. A preferred measure should evolve from the evaluation.
Matrix Keys	
<b>N/A</b>	Not advisable in this situation.
<b>N/P</b>	Not permitted in this situation.
<b>1</b>	Fast flood velocity is conducive to erosion and special features to resist anticipated erosion may be required.
<b>2</b>	Flash flooding usually does not allow time for human intervention; thus, these measures must perform without human intervention. Openings in foundation walls must be large enough to equalize water forces and should not have removable covers. Closures and shields must be permanently in place, and wet floodproofing cannot include last-minute modifications.
<b>3</b>	Permeable soils allow seepage under floodwalls and levees; therefore, some type of subsurface cutoff feature would be needed beneath structures. Permeable soils become saturated under flood conditions, potentially increasing soil pressures against a structure; therefore, some type of foundation drain system or structure may be needed.
<b>4</b>	Ice and debris loads should be considered and accounted for in the design of foundations and floodwall/levee closures.
<b>5</b>	Any retrofitting alternative considered for the floodway must meet NFIP, state, local, and community floodplain requirements concerning encroachment/obstruction of the floodway conveyance area.
<b>6</b>	Not advisable in this situation, unless a specific engineering solution is developed to address the specific characteristic or constraint.

Figure 3-5. Instructions for Retrofitting Screening Matrix

### 3.3.1 Flooding Characteristics

Riverine flooding is usually the result of heavy or prolonged rainfall or snowmelt occurring in upstream inland watersheds. In some cases, especially in and around urban areas, flooding can also be caused by inadequate or improper drainage. In coastal areas subject to tidal effects, flooding can result from wind-driven and prolonged high tides, poor drainage, storm surges with waves, and tsunamis.

There are several important flood characteristics that must be examined to determine which retrofitting measure will be best suited for a specific location: depth and elevation, flow velocity, frequency, rates of rise and fall, duration, and debris impact. These characteristics not only indicate the precise nature of flooding for a given area, but can also be used to anticipate the performance of different retrofitting measures based on the potential hazards associated with each. These factors are outlined below.

#### 3.3.1.1 Flood Depth and Elevation

The depth and elevation of flooding are directly related. Flood depth is measured from the floodwater surface to the adjacent ground level, while flood elevation is measured against an established standard datum. Determining the potential depth of flooding for certain flood frequencies is a critical step because it is often the primary factor in evaluating the potential for flood damage.

A building is susceptible to floods of various depths. Floods of greater depth occur less frequently than those of lesser depths. Potential flood elevations from significant flooding sources are shown in FISs for most participating NFIP communities. For the purpose of assessing the depth of flooding a structure is likely to endure, it is convenient to use the flood levels shown in the study, historical flood levels, and flood information from other sources. The depth of flooding affecting a structure can be calculated by determining the height of the flood above the ground elevation at the site of the structure. Figure 3-6 illustrates historic flood depths documented by measuring mud lines or high water marks on a building.

For those areas outside the limits of an FIS or State, community, or privately prepared local floodplain study, determination of flood depth may require a detailed engineering evaluation of local drainage conditions to develop the necessary relationship between flow (discharge), water-surface elevation, and flood frequency. The designer should contact the local municipal engineer, building official, or floodplain administrator for guidance on computing flood depth in areas outside existing study limits.

Floodwater can impose hydrostatic forces on buildings. These forces result from the static mass of water acting on any point where floodwater contacts a structure. They are equal in all directions and always act perpendicularly (or normally) to the surfaces on which they are applied. Hydrostatic loads can act vertically on structural members such as floors and decks (buoyancy forces) and laterally (hydrostatic forces) on upright structural members such as walls, piers, and foundations. Hydrostatic forces increase linearly as the depth of water increases. Figure 3-7 illustrates the hydrostatic and buoyancy forces generated by water depth.

**Figure 3-6.**  
Measuring mud lines  
or high water marks to  
establish flood depth



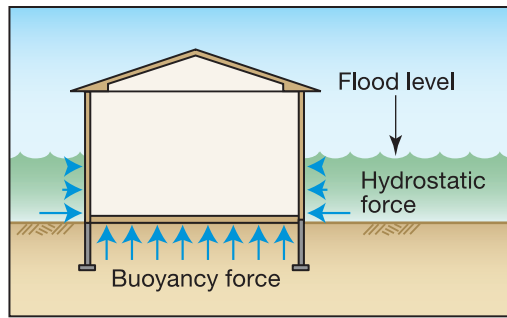

Figure 3-7. Hydrostatic and buoyancy forces

If a well-constructed building is subject to flooding depths of less than 3 feet, it is possible that unequalized hydrostatic forces may not cause significant damage. Therefore, consideration can be given to using barriers, sealants, and closures as retrofitting measures. If shallow flooding (less than 3 feet) causes a basement to fill with water, then wet floodproofing methods can be used to reduce flood damage to basements.

If a residential building is subject to flooding depths greater than 3 feet, either elevation or relocation is often the most effective method of retrofitting. Water depths greater than 3 feet can often create hydrostatic forces with enough load to cause structural damage or collapse if the house is not moved or elevated. One other potential method (provided the cost is not prohibitive) is the use of floodwalls and levees designed to withstand flooding depths greater than 3 feet.

### 3.3.1.2 Flood Flow Velocity

The speed at which floodwater moves (flood flow velocity) is normally expressed in terms of feet per second (ft/sec). Riverine floodwater velocity depends primarily on the slope and roughness of the ground surface. In coastal areas, wind speed also frequently influences flow velocity. Beyond the potential structural damage from hydrodynamic forces and potential debris impact described below, flowing water often causes erosion and scour. Both erosion and scour can weaken structures by undermining the building foundation. Erosion and scour are discussed further in Section 3.3.2.

As floodwater velocity increases, hydrodynamic forces imposed by moving water are added to the hydrostatic forces from the depth of still water, significantly increasing the possibility of structural failure. Hydrodynamic forces are caused by water moving around an object and consist of positive frontal pressure against the structure, drag forces along the sides, and negative pressures on the building's downstream face. Greater velocities can quickly erode, or scour, the soil supporting and/or surrounding buildings. Thus, the frontal pressure, drag, and suction from these fast-moving waters may move a building from its foundation or otherwise cause structural damage or failure.

Unfortunately, there is usually no definitive source of information to determine potential flood velocities in the vicinity of specific buildings. Hydraulic computer models or hand computations based on existing



#### NOTE

The use of existing and historical data can be very useful in analyzing the flood threat. Through interviews with residents, approximate dates of flooding may be established, as well as remembered depths of flooding, types of velocity (moving or standing water), duration of flooding, etc. Once the dates have been established, the designer can check other sources such as newspapers and the National Weather Service for additional information.



floodplain studies may provide flood velocities in the channel and overbank areas. Where current analysis data is not available, historical information from past flood events is probably the most reliable source.

#### 3.3.1.3 Flood Frequency

As discussed in Section 3.1.5, flood frequency analyses define the probability that a flood of a specific size will be equaled or exceeded in any given year. Therefore, a flood elevation with a 1-percent-annual-chance of being equaled or exceeded in any given year is referred to as the “100-year flood.” Table 3-6 illustrates the relationship between flood RIs and the probability of that event occurring within a given period. While the 100-year flood serves as the basis for NFIP insurance rates and regulatory floodplain management requirements, the relative frequency of any given flood (2-year vs. 10-year) can also be helpful when choosing between retrofitting options.

#### 3.3.1.4 Rates of Rise and Fall

In areas of steep topography or those areas with a small drainage area, floodwater can rise very quickly with little or no warning. This condition is known as flash flooding. High velocities usually accompany these floods and may preclude certain types of retrofitting, especially those requiring human intervention. In a flash flooding situation, damage usually begins to occur within 1 hour after significant rainfall. If a building is susceptible to flash floods, insufficient warning time can preclude the installation of shields on windows, doors, and floodwalls, as well as the activation of pump systems and backup energy sources. Temporarily relocating movable contents to a higher level may also be impractical. However, such measures may be effective if a building is not subject to flash flooding and the area has adequate flood warning systems, such as television and radio alerts.



#### WARNING

Flash flooding will usually preclude the use of any retrofitting measure that requires human intervention.

High rates of floodwater rise and fall may also lead to increased hydrostatic pressures. This is due primarily to the fact that the water level inside the structure rises and falls more slowly than the level outside.

#### 3.3.1.5 Flood Duration

In many floodplains, duration is related to rates of rise and fall. With long-duration flooding, certain measures such as dry floodproofing may be inappropriate due to the increased chance of seepage and failure caused by prolonged exposure to floodwater. Long periods of inundation are also more likely to cause greater damage to structural members, interior finishes, and service equipment than short periods.



#### NOTE

A detailed hydrograph can provide information on duration of flooding. However, such information is usually not available, and the cost of creating a new study is usually prohibitive. One potential source of information is to check similarly sized drainage basins in neighboring areas to see if historical data exists.

#### 3.3.1.6 Debris Impact

While not intrinsic to flooding itself, debris impact is a flood hazard directly related to flood characteristics—depth,



velocity, rate of rise and fall—with respect to upstream site characteristics. Rising floodwater can dislodge objects of all types and sizes such as cars, sheds, boulders, rocks, and trees. Once unrestrained, high-velocity and flash floodwater may transport the debris downstream and endanger any object that intersects its path. In colder climates and spring thaws, floodwater may carry chunks of ice that can act as a battering ram on structural and non-structural elements alike. Debris impact can destroy most retrofitting measures as well as the structure itself.

Retrofitting measures suitable for debris impact may include relocation, levees, and armored floodwalls.



#### NOTE

Another flood-related hazard besides debris impact is alluvial fans. Because of the potential for high flood velocities, significant debris flow, and varying channel locations, alluvial fans present many unique challenges. The hazards associated with alluvial fan flooding are discussed in detail in Appendix D of this manual.

### 3.3.2 Site Characteristics

Site characteristics such as site location, erosion vulnerability, and underlying soil conditions play a critical role in the determination of an applicable retrofitting method.

#### 3.3.2.1 Site Location

The floodplain is usually defined as the area inundated by a flood having a 100-year flood frequency. The riverine floodplain is often further divided into a floodway and a floodway fringe.

As defined earlier, the floodway is the portion of the floodplain that contains the channel and enough of the surrounding land to enable floodwater to pass without increasing flood depths greater than a predetermined amount. If there are high flood depths and/or velocities, this area is the most dangerous portion of the riverine floodplain. Also, since the floodway carries most of the flood flow, any obstruction may cause floodwater to back up and increase flood levels. For these reasons, the NFIP and local communities prohibit new construction or substantial improvement in identified floodways that would increase flood levels. Relocation is the recommended retrofitting option for a structure located in a floodway. Community and state regulations may prohibit elevation of structures in this area. However, elevation on an open foundation will allow for more flow conveyance than a structure on a solid foundation.

The portion of the floodplain outside the floodway is called the floodway fringe. This area normally experiences shallower flood depths and lower velocities. With proper precautions, it is often possible to retrofit structures in this area with an acceptable degree of safety.

#### 3.3.2.2 Vulnerability to Erosion

Erosion refers to the wearing or washing away of land masses and occurs in both coastal and riverine environments. Difficult to predict, erosion is capable of threatening existing coastal structures by destroying dunes, lowering ground elevations, transporting sediments landward (overwash), breaching low-lying barrier islands, and undermining coastal bluffs. Erosion may be caused by natural or manmade actions including, but not limited to flood inducing storms, construction, and human activities such as dredging channels, damming rivers and altering surface vegetation. Section 3.3 of FEMA P-55, *Coastal Construction Manual*,

(FEMA, 2011) includes an extensive discussion on the phenomenon of coastal erosion. Similarly, riverine erosion impacts the stability of stream banks and adjacent structures through the interaction of multiple geophysical and geotechnical factors that are listed in Section 4.2 of this publication. Consideration of siting and the erodibility of in situ land masses is critical when retrofitting in the floodplain as fast-moving floodwater can undermine buildings and cause building, floodwall, and levee failure.

Shallow foundation systems generally do not provide sufficient protection against soil erosion without some type of protection or armoring measure of below-grade elements. Shallow foundation systems are prohibited altogether in Zone V new construction for reasons evidenced in Figure 3-8. Significant scour in coastal areas can potentially undermine deep foundation piles, individually and in groups, as described in Section 4.2.2 of this publication. The local office of the NRCS will generally have information concerning the erodibility of the soils native to a specific site. FEMA conducted an erosion mapping feasibility study that concluded that mapping of erosion-prone areas was feasible (FEMA, 1999b).



#### CROSS REFERENCE

The *Riverine Erosion Hazard Areas Mapping Feasibility Study*, (FEMA, 1999b) is located in FEMA's electronic library at <http://www.fema.gov/library/viewRecord.do?id=2209>.

**Figure 3-8.**  
Large, fast-moving waves combined with erosion and scour to destroy this Gulf of Mexico home during Hurricane Opal



#### 3.3.2.3 Soil Type

Permeable soils, such as sand and gravel, are those that allow groundwater flow. In flooding situations, these soils may allow water to pass under floodwalls and levees unless extensive seepage control measures are employed as part of the retrofitting measures. Also, saturated soil pressure may build up against basement walls and floors. These conditions cause seepage, disintegration of certain building materials and structural damage. Floodwalls, levees, sealants, shields, and closures may not be effective in areas with highly permeable soil types.

Saturated soils subject horizontal surfaces, such as floors, to uplift forces, called buoyancy. Like lateral hydrostatic forces, buoyancy forces increase in proportion to the depth of water/saturated soil above the horizontal surface. Figure 3-9 illustrates the combined lateral and buoyancy forces resulting from saturated soil.

For example, a typical wood-frame home without a basement or proper anchoring to the foundation may float if floodwater reaches 3 feet above the first floor. A basement without floodwater in it could fail when the ground is saturated up to 4 feet above the floor. Uplift forces occur in the presence of saturated soil. Therefore, well-designed, high-capacity subsurface drainage systems with sump pumps may be an effective solution and may allow the use of dry floodproofing measures.

Other problems with soil saturated by floodwater need to be considered. If a building is located on unconsolidated soil, wetting of the soil may cause uneven (differential) settlement. The building may then be damaged by inadequate support and subject to rotational, pulling, or bending forces. Some soils, such as clay or silt, may expand when exposed to floodwater, causing massive forces against basement walls and floors. As a result, buildings may sustain serious damage even though floodwater does not enter or even make contact with the structure itself.



#### NOTE

Contact the local office of the NRCS or a local geotechnical engineering firm to obtain guidance on the permeability or consolidation features of soils native to the area. Because the site may have been backfilled with non-native materials during original construction, NRCS data should be carefully used.

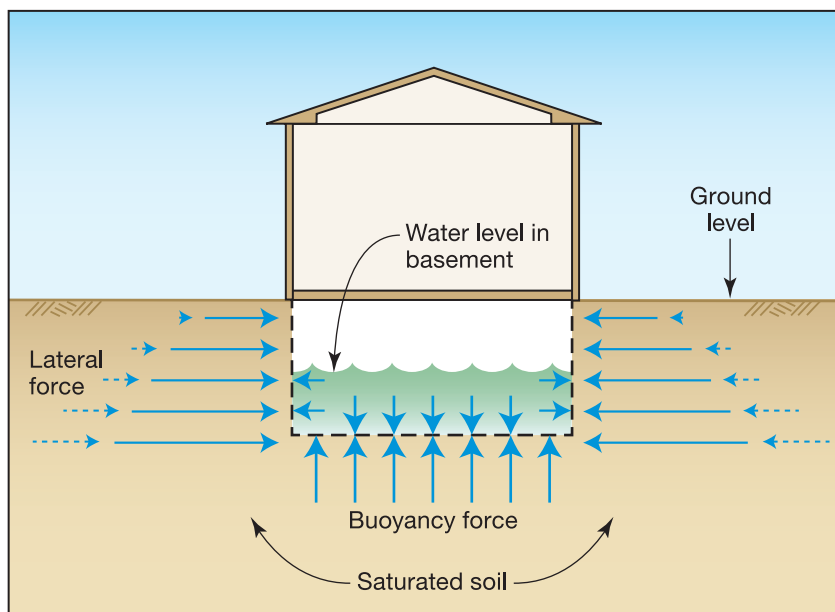

Figure 3-9.  
Lateral and buoyancy  
forces resulting from  
saturated soil

### 3.3.3 Building Characteristics

Ideally, a building consists of three different components: substructure, superstructure, and support services. The substructure consists of the foundation system. The superstructure consists of the structural elements and the building envelope (cladding, roofing, windows and doors, etc.) above the foundation system. The support services are those elements that are introduced into a building to make it habitable.

These components are integrally linked together to help a building maintain its habitability and structural integrity. Any action that considerably affects one may have a minimal or sometimes drastic effect on the others. An understanding of building characteristics and types of construction involved is therefore an important consideration in deciding upon an appropriate retrofitting measure.

#### 3.3.3.1 Substructure

The substructure of a building supports the building envelope. It includes components found beneath the earth's surface, as well as above-grade foundation elements. This system consists of both the vertical foundation elements such as walls, posts, piers, and piles, which support the building loads and transmit them to the ground, and the footings that bear directly on the soil.

At any given time, there are a number of different kinds of loads acting on a building. The foundation system transfers these loads safely into the ground. In addition to dead and live loads, retrofitting decisions must take into account the buoyant uplift thrust on the foundation, the horizontal pressure of floodwater against the building, and any loads imposed by multiple hazards such as wind and earthquake events.

The ability of a foundation system to successfully withstand these and other loads or forces, directly or indirectly, is dependent to a large extent on its structural integrity. A designer should determine the type and condition of a building's foundation system early in the retrofitting evaluation.

All foundations are classified as either shallow or deep. Shallow foundation systems consist of column/piers and wall footings, slab-on-grade, crawlspace, and basement substructures. Deep foundation systems primarily include piles. Even though each of these foundation types may be utilized either individually or in combination with others, most residential buildings located outside coastal high hazard areas are supported on shallow foundations. Each type has its own advantages and limitations when retrofitting measures are being evaluated. Whichever is used in a building, a designer should carefully check for the structural soundness of the foundation system.

Basement walls may be subject to increased hydrostatic and buoyancy forces; thus, retrofitting a building with a basement is often more involved and costly.

#### 3.3.3.2 Superstructure

The superstructure is the portion of the building that includes the load bearing members and the exterior envelope systems above the foundation system (e.g., walls, floors, roofs, ceilings, doors, and other openings). A designer should carefully and thoroughly analyze the existing conditions and component parts of the superstructure to determine the best retrofitting options available. Flood- and non-flood-related hazard effects should also be considered; the uplift, suction, shear, and other pressures exerted on building and roof surfaces by wind and other environmental hazards may be the only reasons needed to rule out elevation as a retrofitting measure.



#### NOTE

A cracked foundation is one indication of a weak foundation. The use of floodwalls and levees may be the easiest and most practical approach to retrofitting a structure with a poor foundation. Another solution may be an entire relocation of the building's super-structure onto a new foundation.

### 3.3.3.3 Support Services

These are elements that help maintain a human comfort zone and provide needed energy, communications, and disposal of water and waste. For a typical residential building, the combination of the mechanical, electrical, telephone, cable TV, water supply, sanitary, and drainage systems provides these services. An understanding of the nature and type of services used in a building is necessary for a designer to be able to correctly predict how they may be affected by retrofitting measures.

For example, the introduction of new materials or the alteration of a building's existing features may require resizing existing services to allow for the change in requirements. Retrofitting may also require some form of relocated ductwork and electrical rewiring. Water supply and waste disposal systems may have to be modified to prevent future damage. This is particularly true when septic tanks and groundwater wells are involved. If relocation is being considered, the designer must consider all these parameters and weigh the cost of repairs and renovation against the cost of total replacement.

### 3.3.3.4 Building Construction

Modern buildings are constructed with a limitless palette of materials integrated into various structural systems. A building may be constructed with a combination of various materials. Thus, the suitability of applying a specific retrofitting measure may be difficult to assess.

Concrete and masonry construction may be considered for all types of retrofitting measures, whereas other materials may not be structurally sound or flood damage-resistant and therefore not suitable for some measures. When classifying building construction as concrete and masonry, it is important that all walls and foundations be constructed of this material. Otherwise, there may be a weak link in the retrofitting measure, raising the potential for failure when floods exert hydrostatic or hydrodynamic forces on the structure.

Masonry-veneer-over-wood-frame construction must be identified since wood-frame construction is less resistant to lateral loading than a brick-and-block wall section.

### 3.3.3.5 Building Condition

A building's condition may be difficult to evaluate, as many structural defects are not readily apparent. However, careful inspection of the property should provide for a classification of "excellent to good" or "fair to poor." This classification is only for the reconnaissance phase of selecting appropriate retrofitting measures. More in-depth planning and design may alter the initial judgment regarding building condition, thereby eliminating some retrofitting measures from consideration at a later time.



#### NOTE

For general consideration of retrofitting measures, all construction should be classified as wood material unless all walls and foundations are concrete and masonry.



#### NOTE

Typically, a designer will begin a retrofitting project with an initial analysis of the present conditions. Decisions based on early findings may be revised after a more detailed analysis.



Analysis of a building's substructure, superstructure, and support services may be done in two stages: an initial analysis usually based on visual inspection, and a detailed analysis (discussed in Section 5.2) that is often more informative, involves greater scrutiny, and usually requires detailed engineering calculations.

In the course of an analysis, a designer should visually inspect the walls, floors, roof, ceiling, doors, windows, and other superstructure and substructure components. Walls should be examined for type of material, structural stability, cracks, and signs of distress. A crack on a wall or dampness on concrete, plaster, wood siding, or other wall finishes may be a sign of concealed problems. Doors, windows, skylights, and other openings should be checked for cracks, rigidity, structural strength, and weather resistance.

Metal-clad wood doors or panel doors with moisture-resistant paint, plastic, or plywood exterior finishes may appear fine even though the interior cores may be damaged. Aluminum windows should be checked for deterioration due to galvanic action or oxidation from contact with floodwater. Steel windows may be damage-free if they are well protected against corrosion. Wood windows require inspection for shrinkage and warping, and for damage from moisture, mold, fungi, and insects.

Flooring in a building can include a vast range of treatments. It involves the use of virtually every material that can be walked upon, from painted concrete slabs to elegant, custom-designed wood parquet floors. A designer should investigate the nature of both the floor finishes and the underlying subfloor. Vinyl or rubberized plastic finishes may appear untouched due to their resistance to indentations and water; however, the concrete or wood subfloor may have suffered some damage. Likewise, a damage-free subfloor may be covered with a scarred finish.

An initial analysis of the conditions of the roof and ceiling of a building can be done by observation during the early decision-making stage. An understanding of the materials and construction methods will be necessary at a later date to fully evaluate the extent of possible damage and need to retrofit. The roofs over most residential buildings consist of simple to fairly complex wood framing that carries the ceilings below and plywood roof decks above, over which the roof finishes are placed. Finish materials include asphalt, wood, metal, clay and concrete tile, asbestos, and plastic and are available in various compositions, shapes, and sizes. In some cases, observation may be enough to determine the suitability, structural rigidity, and continuing durability of a roof system. However, it may be necessary to pop up a ceiling tile; remove some shingles, slate, or roof tiles, or even bore into a roof to achieve a thorough inspection.

The inspection also determines if the building materials and component parts are sound enough for the building to easily undergo the process of elevation, relocation, or dry or wet floodproofing. If not, floodwalls or levees around the structure may be the best alternative if allowable.

Figure 3-10 presents a two-page worksheet that a designer can use to document findings during the initial building condition survey.



Preliminary Building Condition Worksheet – Superstructure				
Owner Name: _____			Prepared By: _____	
Address: _____			Date: _____	
Property Location: _____				
Exterior Finish: <input type="checkbox"/> Siding <input type="checkbox"/> Brick <input type="checkbox"/> Stucco <input type="checkbox"/> Other _____				
Structure Level Floor/Wall	Composition Material/Spacing	Covering/Subfloor	Condition	Cracks/Water Damage Description/Location
<b>First: Floor</b>				
<b>First: Walls</b>				
Exterior				
Interior				
<b>Second: Floors</b>				
<b>Second: Walls</b>				
Exterior				
Interior				
<b>Attic: Floors</b>				
<b>Attic: Walls</b>				
Exterior				
Interior				
<b>Roof</b>				
<b>Decks/Porches</b>				
Structure Level Component	Total #	Composition	Condition	Cracks/Water Damage Description/Location
<b>First: Windows</b>				
<b>First: Exterior Doors</b>				
<b>Second: Windows</b>				
<b>Second: Exterior Doors</b>				
<b>Attic Windows</b>				
<b>Skylights</b>				

Figure 3-10. Preliminary Building Condition Worksheet (page 1 of 2)

### 3 PARAMETERS OF RETROFITTING

Preliminary Building Condition Worksheet – Substructure and Service				
Owner Name: _____		Prepared By: _____		
Address: _____		Date: _____		
Property Location: _____				
Exterior Finish: <input type="checkbox"/> Siding <input type="checkbox"/> Brick <input type="checkbox"/> Stucco <input type="checkbox"/> Other _____				
Foundation				
Foundation Type	Wall Composition	Wall Thickness or Pile Size	Condition	Cracks/Water Damage Description/Location
<input type="checkbox"/> Monolithic slab	<input type="checkbox"/> Masonry; CMU only			
<input type="checkbox"/> Stem wall slab	<input type="checkbox"/> Masonry; CMU and brick			
<input type="checkbox"/> Basement	<input type="checkbox"/> ICF*			
<input type="checkbox"/> Crawlspace	<input type="checkbox"/> Poured concrete			
<input type="checkbox"/> Timber piles	<input type="checkbox"/> Pre-cast			
<input type="checkbox"/> Other _____	<input type="checkbox"/> Other _____			
Support Services				
Service	Type	Location	Condition	Comment
Water Supply	<input type="checkbox"/> Municipal <input type="checkbox"/> Well			
Wastewater Removal	<input type="checkbox"/> Municipal <input type="checkbox"/> Septic			
Electrical	<input type="checkbox"/> Above-ground supply <input type="checkbox"/> Below-ground supply <input type="checkbox"/> Other			
Gas	<input type="checkbox"/> Municipal <input type="checkbox"/> Other _____			
Heat	<input type="checkbox"/> Gas furnace <input type="checkbox"/> Other _____			
Air Conditioning	<input type="checkbox"/> Central <input type="checkbox"/> Other _____			
Ventilation				
Cable/Fiber Optic				
Telephone				

\* ICF = insulated concrete forms

Figure 3-10. Preliminary Building Condition Worksheet (page 2 of 2)

## 3.4 Balancing Historic Preservation With Flood Protection

Many historic building features were developed, either deliberately or intuitively, as responses to natural and environmental hazards, and to local climate or topography. Recognizing how and why these features were intended to work can help in designing a program of preventive measures that is historically appropriate and that minimizes incongruous modifications to historic residential properties.

There are retrofitting steps that will not have a negative or even significant impact upon the historic character of a site or its particular features. Preventive measures can be carried out without harming or detracting from historic character, as long as design and installation are carefully supervised by a professional knowledgeable in historic preservation. State and local historic preservation offices may require plan review and approval for flood retrofit projects on historic buildings.

There may well be instances, however, when a measure that best protects the site also may result in some loss of historic character. In such a case, the owner and the designer will have to weigh the costs of compromising character or historic authenticity against the benefits of safeguarding the site or a particular site feature against damage or total destruction. One example of such a choice is the decision whether to elevate a historic structure located in a flood hazard area, relocate it out of the area, retrofit it with dry or wet floodproofing techniques, or leave it in its existing state to face the risks of damage or loss. It is difficult to prescribe an equation for such a decision, since each situation will be unique, considering location, structural or site conditions, the variety of preventive alternatives available, cost, and degree of potential loss of historic character. Here are some questions the designer may wish to pose in deliberating such a decision:

- What is the risk that the historic feature or the entire site could be totally destroyed or substantially damaged if the preventive measure is not taken? If the measure is taken, to what degree will this reduce the risk of damage or total destruction?
- Are there preventive alternatives that provide less protection from flood damage, but also detract less from historic character? What are they, and what is the trade-off between protection and loss of character?
- Is there a design treatment that could be applied to the preventive measure to lessen detracting of historic character?

## 3.5 Multiple Hazards

The selection of a retrofitting method may expose the structure to additional non-flood environmental hazards that could jeopardize the safety of the structure. These multiple hazards can be accommodated through careful design of the retrofitting measures or may necessitate selection of a different retrofitting method. Detailed information concerning the analysis and design for these multiple hazards is contained in Chapters 4 and 5.

Significant flood-related hazards to consider include ice and debris flow, impact forces, erosion forces. These hazards were discussed in Sections 3.3.1 and 3.3.2. Mudslide or alluvial fan impacts are addressed in Appendix D. The major non-flood-related hazards to consider include earthquake and wind forces. Less significant hazards addressed in Chapter 4 include land subsidence, fire hazards, snow loads, movable bed

streams, and closed basin lakes. Multiple hazards may affect a structure independently, as with flood and earthquakes, or concurrently, as with flood and wind in a coastal area.

Older buildings and structures were typically constructed to resist gravity loads only. Gravity loads consisted of vertical downward loads (its own weight or dead load) plus loads that considered building contents and people (live loads) on the floors. The roofs of the structures were constructed to resist rain and snow. However, the designer of the structures may not have considered lateral and uplift loads from earthquakes and winds.

#### 3.5.1 Earthquake Forces

Earthquakes generate dynamic seismic ground motion acceleration forces that may be simplified into static lateral forces using methods like the Equivalent Lateral Force Procedure in ASCE 7-10. Subsequently, the designer divides and distributes the resultant lateral force vertically across the different levels of the modeled structure. The structural configuration of the overall building, height above base, and the vertical combination of individual structural systems affect the load distribution and therefore demand critical consideration in the retrofitting process. Shear walls, lateral connections between each level, foundation reinforcement, and anchorage must be analyzed and, in some cases, retrofitted to withstand earthquake forces as part of the complete retrofit project.



#### NOTE

FEMA 530, *Earthquake Safety Guide for Homeowners* (FEMA, 2005b) introduces the basics of strengthening homes against earthquake damage and illustrates the relative cost of prevention versus repair or replacement.

For guidance on seismic retrofits of existing homes, see FEMA 232, *Homebuilders' Guide to Earthquake Resistant Design and Construction* (FEMA, 2006a).

#### 3.5.2 Wind Forces

High winds impose forces on a home and the structural elements of its foundation. Damage potential is increased when the wind forces occur in combination with flood forces. In addition, when a structure or home is elevated to minimize the effects of flood forces, the wind loads on the elevated structure may be increased. FEMA P-762, *Local Officials Guide for Coastal Construction* (FEMA, 2009b) provides a detailed discussion of this topic. Occasionally, structural elements are laid on top of each other with minimal fastening. However, wind forces can be upwards, or from any direction exerting considerable pressure on structural components such as walls, roofs, connections, and anchorage. Therefore, wind loads should be considered in the design process at the same time as hydrostatic, hydrodynamic, and impact dead and live loads as prescribed under the applicable codes.



#### NOTE

FEMA P-804, *Wind Retrofit Guide for Residential Buildings* (FEMA, 2010b) provides guidance to improve the performance of homes in hurricane-prone regions throughout the U.S. Wind damage is mitigated through the implementation of groups of mitigation actions or packages that strengthen the building structure and its components.



# 4 Determination of Hazards

Chapters 1 through 3 introduced retrofitting and guided the designer through the technical process of pre-selecting retrofitting techniques for consideration. In this chapter, the analyses necessary to determine the flood- and non-flood-related forces and other site-specific considerations that control the design of a retrofitting measure are presented. This information may be useful in determining which retrofitting alternatives are technically feasible, and in preparing BCAs for those alternatives. The analysis of hazards contributes to the design criteria for retrofitting measures, which are described in Chapter 5.

Retrofitting measures must be designed, constructed, connected, and anchored to resist flotation, collapse, and movement due to all combinations of loads and geotechnical conditions appropriate to the situation, including:

- flood-related hazards, such as hydrostatic and hydrodynamic forces, flood-borne debris impact forces, and site drainage considerations;
- site-specific flood-related hazards, such as alluvial fans, closed basin lakes, and movable bed streams;
- non-flood-related environmental loads, such as earthquake and wind forces; and
- site-specific soil or geotechnical considerations, such as soil pressure, bearing capacity, land subsidence, erosion, scour, and shrink-swell potential.

## 4.1 Analysis of Flood-Related Hazards

The success of any retrofitting measure depends on an accurate assessment of the flood-related forces acting upon a structure. Floodwater surrounding a building exerts a number of forces on the structure, including



## 4 DETERMINATION OF HAZARDS

lateral and vertical hydrostatic forces, hydrodynamic forces, and debris impact forces. In addition, certain flood-related conditions may pose a danger and require evaluation (e.g., site drainage, lake flooding, erosion debris flows) (see Figure 4-1).

Standing water or slow moving water can induce horizontal hydrostatic forces (pressures) against a structure, especially when floodwater levels on different sides of the structure are not equal. Saturated soils beneath the ground surface also impose hydrostatic loads on foundation components.



Figure 4-1. Flood-related hazards (top left: alluvial fan; top right: moveable bed stream; bottom left: closed basin lake; bottom right: interior drainage)

Hydrodynamic forces result from the velocity flow of water against or around a structure. These velocity flows, if fast enough, are capable of destroying solid walls and dislodging buildings with inadequate foundations. Impact loads are imposed on the structure by water-borne objects and their effects become greater as the velocity of flow and the weight of the objects increase. The basic equations for analyzing and considering these flood-related forces are provided in this chapter.

Minimum standards for flood-resistant design may be found in *Minimum Design Loads for Buildings and Other Structures* (ASCE 7) and *Flood Resistant Design and Construction* (ASCE 24). Equations for calculating the aforementioned forces for flood-related hazards can be found in technical publications from FEMA, such as FEMA P-55, *Coastal Construction Manual* (FEMA, 2011). FEMA P-55 provides guidance for designing and constructing residential buildings in coastal areas that will be more resistant to the damaging effects of natural hazards. The focus of this manual, FEMA 259, is on new residential construction and substantial improvement to existing residential buildings, principally detached single-family homes, attached single-family homes (townhouses), and low-rise (three-story or less) multi-family buildings.

**NOTE**

Additional information concerning the determination of flood-related forces is available in Section 5 of ASCE 7, *Minimum Design Loads for Buildings and Other Structures* (2010).

Minimum standards for flood-resistant design are available in ASCE 24, *Flood Resistant Design and Construction Standard* (2005).

### 4.1.1 Determining Flood Elevations

Determining the expected flood depth at a site is critical for the overall determination of flood-related hazards. The method for making this determination can vary depending on whether the site is subject to riverine or coastal flooding.

#### 4.1.1.1 Riverine Areas

One method of determining the 100-year water-surface elevation involves using a DFIRM panel or a FIRM panel. The DFIRM or FIRM panel identifies the specific flood zone(s) and BFEs of the project area in question. For simplicity purposes, this manual, FEMA 259, determines flood depths using the DFIRM. On most DFIRMs, floodplain limits are delineated for the 1- and 0.2-percent-annual-chance flood. As an example, Figure 4-2 shows the portion of a community's DFIRM where a subject house is located.

In this example, the location of the house was determined by measuring the distance from the intersection of Anderson Drive and Shaftsberry Court. The house is located approximately 325 feet southeast of the intersection. Converting this distance to the map's scale (1 inch equals 500 feet), the house is 0.65 inch along Shaftsberry Court from its intersection with Anderson Drive.

The blue-dotted shading on the map represents the 100-year floodplain. The black-dotted shading denotes the 500-year floodplain. The house is located within the 100-year floodplain, in between the two wavy lines labeled 214. These lines denote

**NOTE**

Note that for maps with small scales (greater than 1"=400'), converting feet to inches can introduce inaccuracies in locating the home and in specifying the flood elevations impacting the site.





Figure 4-2. House and stream location on the DFIRM

the 100-year flood elevation at that location of Big Branch (Stream 21). Therefore, the 100-year flood elevation affecting the house in this example is 214 feet, based on the NAVD.

Flood elevations for the other frequencies are shown on the stream's water-surface profile in the FIS. For the above example, the position of the house on Big Branch (Stream 21) was determined by using the cross section line perpendicular to the stream labeled 023 as a reference point and measuring approximately 25 feet or 0.05 inch south on the DFIRM. The location of the stream is shown in Figure 4-2.

The house can be located on the Big Branch (Stream 21) flood profile (Figure 4-3) and measured 0.125 inch downstream of cross section 023 (25 divided by 200 feet per inch, which is the horizontal scale of the profile). This location is marked as the point on Big Branch (Stream 21) with water-surface elevations equivalent to the house. The elevations on the profile at this point are 207.0, 213.9, and 219.0 feet for the 10-, 100-, and 500-year floods, respectively. The bottom of the Big Branch (Stream 21) channel shown on the profile is at 191.7 feet.

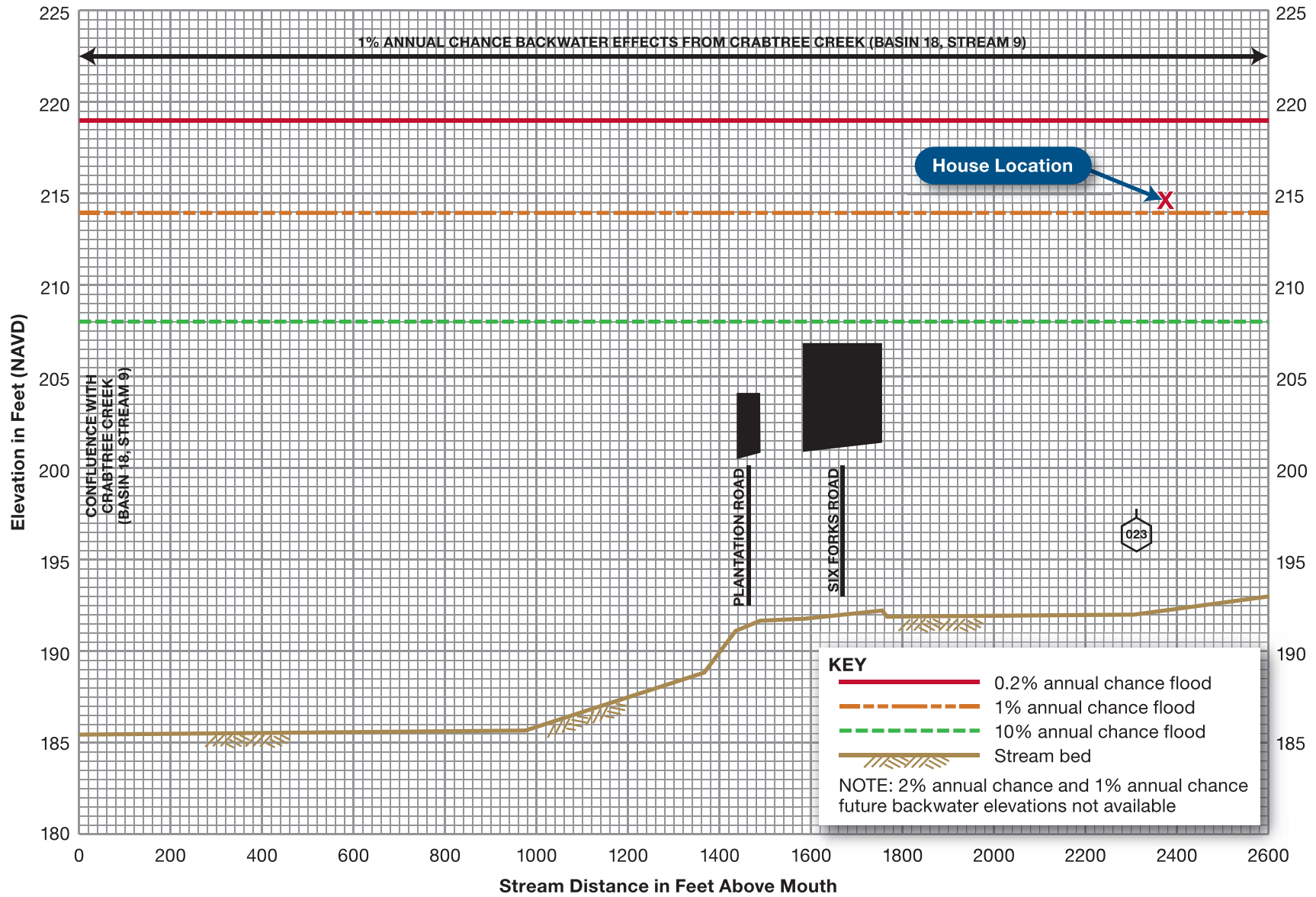

Figure 4-3. House location on flood profile for Big Branch (Stream 21)

## 4 DETERMINATION OF HAZARDS

Since Big Branch (Basin 18, Stream 21) is mapped as a Zone AE and has a floodway, a floodway data summary table can be obtained from the FIS. Table 4-1 depicts the floodway data table for this example. The regulatory BFE is listed as 213.9 feet below.

Table 4-1. Floodway Data Summary Table for Big Branch (Stream 21)

Flooding Source		Floodway			Base Flood Water-Surface Elevation (ft NAVD 88)			
Cross Section	Distance <sup>a</sup>	Width (ft)	Section Area (ft <sup>2</sup> )	Mean Velocity (ft/sec)	Regulatory	Without Floodway	With Floodway	Increase
Big Branch (Basin 10, Stream 8)								
013	1,255	110	419	3.3	254.0	253.6 <sup>b</sup>	254.6	1.0
054	5,360	70	156	6.5	276.3	276.3	276.3	0.0
Big Branch (Basin 18, Stream 21)								
023	2,308	140	1,193	3.0	213.9	209.0 <sup>c</sup>	209.4	0.4
028	2,765	110	1,024	3.5	213.9	209.5 <sup>c</sup>	209.8	0.3
034	3,358	120	773	4.6	213.9	210.1 <sup>c</sup>	210.6	0.5
043	4,297	70	439	7.6	213.9	214.0 <sup>c</sup>	214.9	0.9
048	4,813	40	430	7.8	220.1	220.1	220.2	0.1
058	5,774	100	1,918	2.1	232.8	232.8	233.5	0.7

SOURCE: FEMA FIS REPORT FOR WAKE COUNTY, NC

a. Feet above mouth

b. Elevation computed without consideration of backwater effects from Little River (Basin 10, Stream 1)

c. Elevation computed without consideration of backwater effects from Crabtree Creek (Basin 18, Stream 9)

### 4.1.1.2 Coastal Areas

In coastal areas, the determination of the expected water surface elevation for the various RI floods is made by locating the structure and its flooding source on the DFIRM, identifying the corresponding flooding source/location row on the summary of stillwater elevation table, and selecting the appropriate elevation for the RI in question.

As an example, consider a building located on Marsh Bay Drive (as depicted on Figure 4-4). From the DFIRM, we can identify the flooding source as the Atlantic Ocean. The marked structure is located in a Zone AE, and has a BFE of 14 feet. In coastal areas, the BFE is equal to the stillwater elevation plus the associated wave height.

A review of the entire area map for the FIS would indicate the structure on Marsh Bay Drive is located between transect lines 46 and 47.



#### CROSS REFERENCE

A detailed discussion of the methodologies involved in computing wave heights and runup is beyond the scope of this manual. For more information, refer to:

- *Guidance for Wave Elevation Determination and V Zone Mapping* (FEMA, 2003)
- *Guidance for Pacific Coast of the United States* (FEMA, 2005a)
- *Guidance for Atlantic and Gulf Coasts of the United States* (FEMA, 2007)
- FEMA P-55, *Coastal Construction Manual*, Fourth Edition, (FEMA, 2011)



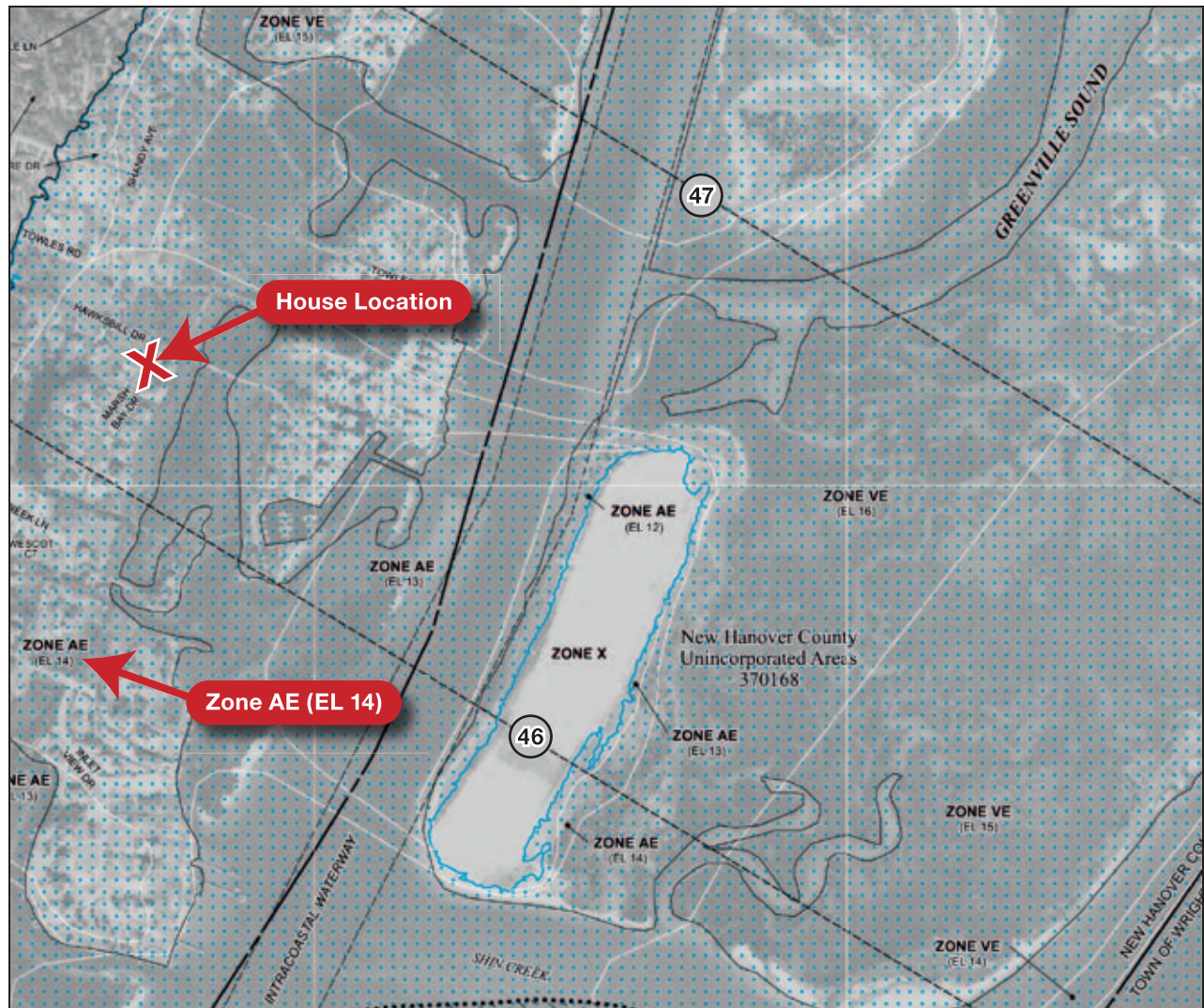

Figure 4-4. Coastal DFIRM showing house location and flood elevation

This flooding source/location is on the summary of stillwater elevations table (Table 4-2). From this table, the identified transect numbers are used to determine the stillwater flood elevations. Stillwater flood elevations of 5.7, 8.7, 12.2, and 12.4 feet in NAVD are identified for the 10-, 50-, 100-, and 500-year frequency floods (10-percent, 2-percent, 1-percent, and 0.2-percent-annual-exceedance probabilities), respectively.

**Table 4-2. Summary of Coastal Analysis for the Atlantic Ocean Flooding Source**

No.	Transect Location	Stillwater Elevation in ft NAVD 88				Wave Runup Analysis Zone Designation and BFE in ft NAVD 88	Wave Height Analysis Zone Designation and BFE in ft NAVD 88	Primary Frontal Dune Identified
		10% Annual Chance	2% Annual Chance	1% Annual Chance	0.2% Annual Chance			
45	Approximately 1.87 miles southeast of the intersection of Orchard Trc and Masonboro Sound Rd	5.7	8.7	12.2	12.4	N/A	VE 14-19 AE 12-14	Yes
46	Approximately 690 ft southeast of intersection of Jack Parker Blvd and S Lumina Ave	5.7	8.7	12.2	12.4	N/A	VE 14-19 AE 12-14	Yes
47	Approximately 580 ft southeast of the intersection of S Lumina Ave and Sunset Ave	5.7	8.7	12.2	12.4	N/A	VE 14-19 AE 12-14	Yes
48	Approximately 550 ft east of the intersection of S Lumina Ave and Bridgers St	5.7	8.7	12.2	12.4	N/A	VE 14-19 AE 12-14	Yes

SOURCE: FEMA FIS REPORT FOR NEW HANOVER COUNTY, NC

### 4.1.2 Flood Forces and Loads

Floodwater can exert a variety of forces on a building. This section describes these forces, which include hydrostatic, saturated soil, hydrodynamic, debris impact, and erosive forces and illustrates how they are computed.

#### 4.1.2.1 Flood Depth and Floodproofing Design Depth

After gathering flood data from the riverine or coastal DFIRM and FIS, it is possible to compute the depth of flooding at a structure for any of the RIs defined along the flooding source. Flood depth can be computed by subtracting the lowest ground surface elevation (grade) adjacent to the structure from the flood elevation for each flood frequency, as shown in Equation 4-1. Sample calculations using these equations are presented in Appendix C.

Many communities have chosen to exceed minimum NFIP building elevation requirements, usually by requiring freeboard above the BFE, but sometimes by regulating to a more severe flood than the base flood. In this manual, “design flood elevation” refers to the locally adopted regulatory flood elevation. If a community regulates to minimum NFIP requirements, the DFE is identical to the BFE. If a community has chosen to exceed minimum NFIP elevation requirements, the DFE exceeds the BFE. The DFE is always



### EQUATION 4-1: FLOOD DEPTH

$$d = FE - GS \quad (\text{Eq. 4-1})$$

where:

- $d$  = depth of flooding (ft)
- $FE$  = flood elevation for a specific flood frequency (ft)
- $GS$  = lowest ground surface elevation (grade) adjacent to a structure (ft)

#### NOTE

When computing flood depth, be sure to use the lowest ground surface adjacent to the structure in question as shown in Figure 4-5.

equal to or greater than the BFE and includes wave effects. One common way of specifying the DFE, using freeboard above BFE, is illustrated in Equation 4-2. Communities incorporate freeboard with the intent that structures be elevated above this level, but they may or may not intend that all design loads be based on this elevation (many communities require freeboard to achieve flood insurance premium savings or Community Rating System [CRS] discount points). The rationale for freeboard adoption should be investigated before flood loads are calculated.



### EQUATION 4-2: COMMON DEFINITION OF DESIGN FLOOD ELEVATION

$$DFE = FE + f \quad (\text{Eq. 4-2})$$

where:

- $DFE$  = design flood elevation (ft)
- $FE$  = flood elevation for a specific flood frequency (ft)
- $f$  = factor of safety (freeboard), typically a minimum of 1.0 ft

Determining the floodproofing design depth at the structure is very important for the flood load calculation process. Nearly every other flood load parameter or calculation (e.g., hydrostatic load, hydrodynamic load, vertical hydrostatic load, debris impact load, and local scour depth) depends directly or indirectly on the floodproofing design depth. The floodproofing design depth ( $H$ ) is the difference between the DFE and the lowest grade adjacent to the structure (Figure 4-5). This computation is shown in Equation 4-3.





## EQUATION 4-3: FLOODPROOFING DESIGN DEPTH

$$H = DFE - GS \quad (\text{Eq. 4-3})$$

where:

$H$  = floodproofing design depth over which flood forces are considered (ft)

$DFE$  = design flood elevation (ft)

$GS$  = lowest ground surface elevation (grade) adjacent to the structure (or other reference feature such as a slab or footing) (ft)

Figure 4-5.  
Flood depth and design depth

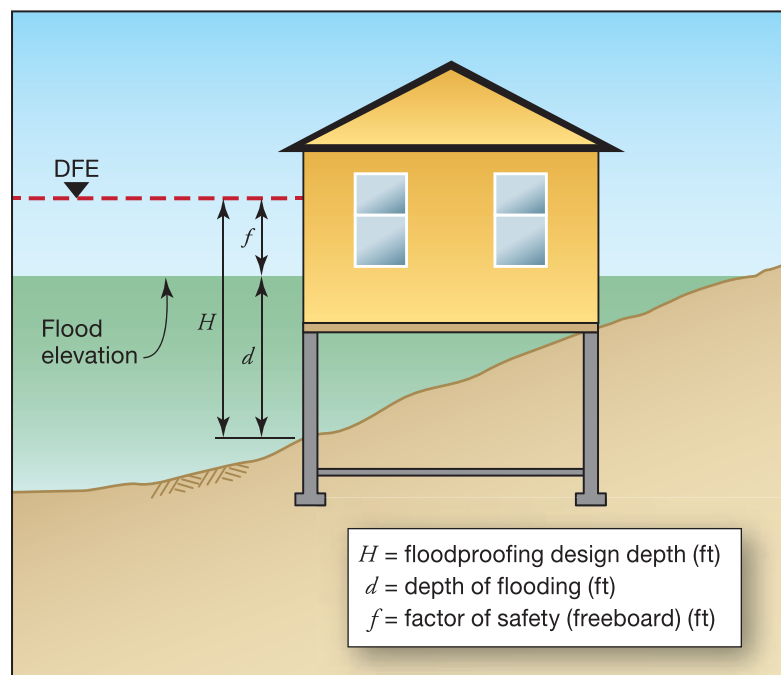

#### 4.1.2.2 Hydrostatic Forces

The pressure exerted by still and slow moving water is called “hydrostatic pressure.” During any point of floodwater contact with a structure, hydrostatic pressures are equal in all directions and always act perpendicular to the surface on which they are applied. Pressures increase linearly with depth or “head” of water above the point under consideration. The summation of pressures over the surface under consideration represents the load acting on that surface. For structural analysis, hydrostatic forces, as shown in Figures 4-6 and 4-7, are defined to act:

- vertically downward on structural elements such as flat roofs and similar overhead members having a depth of water above them;

Hydrostatic Forces
Lateral water pressure
Combined water and saturated soil pressure
Equivalent hydrostatic pressures due to velocity
Vertical (buoyancy) water pressure

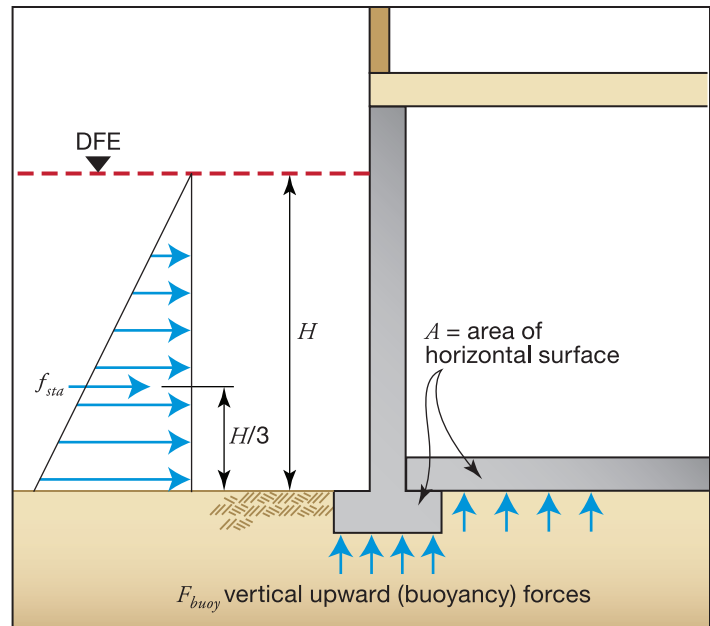

Figure 4-6. Hydrostatic forces

Figure 4-7. Diagram of hydrostatic forces

- vertically upward (uplift) from the underside of generally horizontal members such as slabs, floor diaphragms, and footings (also known as buoyancy); and
- laterally, in a horizontal direction on walls, piers, and similar vertical surfaces. (For design purposes, this lateral pressure is generally assumed to act on the receiving structure at a point one-third of the water depth above the base of the structure or two-thirds of the altitude from the water surface, which correlates to the center of gravity for a triangular pressure distribution.)

Hydrostatic forces include lateral water pressures, combined water and soil pressures, equivalent hydrostatic pressures due to velocity flows, and vertical (buoyancy) water pressures. The computation of each of these pressures is illustrated in the sections that follow.

For the purpose of this document, it has been assumed that hydrostatic conditions prevail for stillwater and water moving with a velocity of less than 10 ft/sec.

Hydrostatic loads generated by velocities up to 10 ft/sec may be converted to an equivalent hydrostatic load using the conversion equation, Equation 4-8, presented later in this chapter.

### 4.1.2.3 Lateral Hydrostatic Forces

The basic equation for analyzing the lateral force due to hydrostatic pressure from standing water above the surface of the ground is illustrated in Equation 4-4.



## EQUATION 4-4: LATERAL HYDROSTATIC FORCES

$$f_{sta} = \frac{1}{2} P_b H = \frac{1}{2} \gamma_w H^2 \quad (\text{Eq. 4-4})$$

where:

$f_{sta}$  = hydrostatic force from standing water (lb/lf) acting at a distance  $H/3$  above ground

$P_b$  = hydrostatic pressure due to standing water at a depth of  $H$  (lb/ft<sup>2</sup>), ( $P_b = \gamma_w H$ )

$\gamma_w$  = specific weight of water (62.4 lb/ft<sup>3</sup> for fresh water and 64.0 lb/ft<sup>3</sup> for saltwater)

$H$  = floodproofing design depth (ft)

## 4.1.2.4 Saturated Soil Forces

If any portion of the structure is below grade, saturated soil forces must be included in the computation in addition to the hydrostatic force. The equivalent fluid pressures for various soil types are presented in Tables 4-3 and 4-4. The equivalent fluid weight of saturated soil is not the same as the effective weight of saturated soil. Rather, the equivalent fluid weight of saturated soil is a combination of the unit weight of water and the effective saturated weight of soil.

Table 4-3. Effective Equivalent Fluid Weight of Submerged Soil and Water

Soil Type*	Equivalent Fluid Weight of Submerged Soil and Water (lb/ft <sup>3</sup> )
Clean sand and gravel (GW, GP, SW, SP)	75
Dirty sand and gravel of restricted permeability (GM, GM-GP, SM, SM-SP)	77
Stiff residual silts and clays, silty fine sands, clayey sands and gravels (CL, ML, CH, MH, SM, SC, GC)	82
Very soft to soft clay, silty clay, organic silt and clay (CL, ML, OL, CH, MH, OH)	106
Medium to stiff clay deposited in chunks and protected from infiltration (CL, CH)	142

\*Soil types are based on USDA Unified Soil Classification System; see Table 4-4 for soil type definitions.

Table 4-4. Soil Type Definitions Based on USDA Unified Soil Classification System

Soil Type	Group Symbol	Description
Gravels	GW	Well-graded gravels and gravel mixtures
	GP	Poorly graded gravel-sand-silt mixtures
	GM	Silty gravels, gravel-sand-silt mixtures
	GC	Clayey gravels, gravel-sand-clay mixtures
Sands	SW	Well-graded sands and gravelly sands
	SP	Poorly graded sands and gravelly sands
	SM	Silty sands, poorly graded sand-silt-mixtures
	SC	Clayey sands, poorly graded sand-clay mixtures
Fine Grain Silt and Clays	ML	Inorganic silts and clayey silts
	CL	Inorganic clays of low to medium plasticity
	OL	Organic silts and organic silty clays of low plasticity
	MH	Inorganic silts, micaceous or fine sands or silts, elastic silts
	CH	Inorganic clays of high plasticity, fine clays
	OH	Organic clays of medium to high plasticity

4.1.2.5 Combined Saturated Soil and Water Forces

When a structure is subject to hydrostatic forces from both saturated soil and standing water (illustrated in Figure 4-8), the resultant combined lateral force,  $f_{comb}$ , is the sum of the lateral water hydrostatic force,  $f_{sta}$ , and the differential between the water and soil pressures,  $f_{dif}$ . The basic equation for computing  $f_{dif}$  is shown in Equation 4-5.

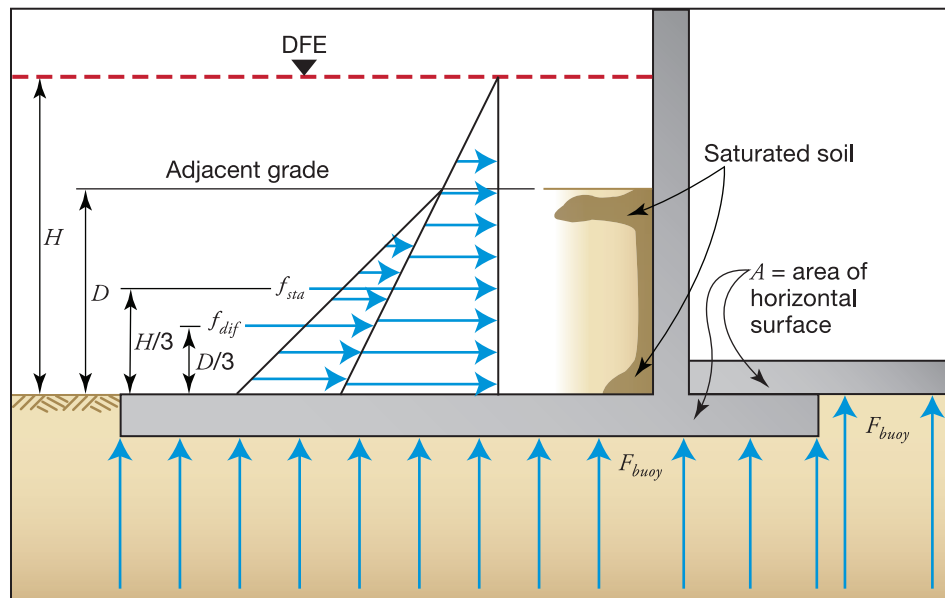

Figure 4-8. Combination soil/water hydrostatic and buoyancy forces



## EQUATION 4-5: SUBMERGED SOIL AND WATER FORCES

$$f_{dif} = \frac{1}{2}(S - \gamma_w)D^2 \quad (\text{Eq. 4-5})$$

where:

$f_{dif}$  = differential soil/water force acting at a distance  $D/3$  from the point under consideration (lb/lf)

$S$  = equivalent fluid weight of submerged soil and water (lb/ft<sup>3</sup>) as shown in Table 4-3

$D$  = depth of saturated soil from adjacent grade to the top of the footer (ft)

$\gamma_w$  = specific weight of water (62.4 lb/ft<sup>3</sup> for fresh water and 64.0 lb/ft<sup>3</sup> for saltwater)

## NOTE

$f_{dif}$  acts at a point  $D/3$  where  $D$  is the distance from the adjacent grade to the top of the foundation footer.

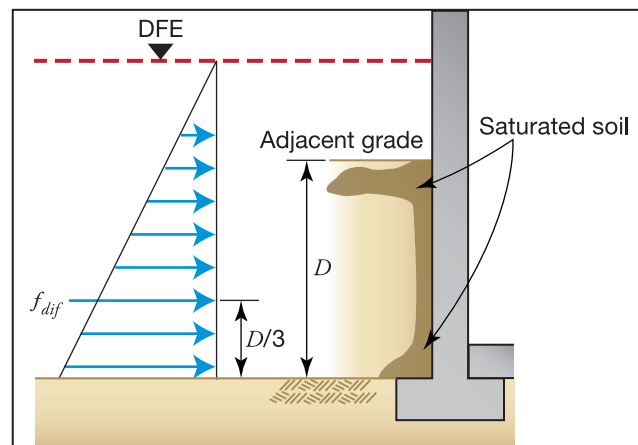

## 4.1.2.6 Vertical Hydrostatic Forces

The basic equation for analyzing the vertical hydrostatic force (buoyancy) due to standing water (illustrated by Figure 4-7) is shown in Equation 4-6.

The computation of hydrostatic forces is vital to the successful design of floodwalls, sealants, closures, shields, foundation walls, and a variety of other retrofitting measures. The Hydrostatic Force Computation Worksheet (Figure 4-9) can be used to conduct hydrostatic calculations.



**EQUATION 4-6: BUOYANCY FORCES**

$$F_{buoy} = \gamma_w (Vol) \tag{Eq. 4-6}$$

where:

$F_{buoy}$  = vertical hydrostatic force resulting from the displacement of a given volume of floodwater (lb)

$\gamma_w$  = specific weight of water (62.4 lb/ft<sup>3</sup> for fresh water and 64.0 lb/ft<sup>3</sup> for saltwater)

$Vol$  = volume of floodwater displaced by a submerged object (ft<sup>3</sup>)

Hydrostatic Force Computation Worksheet	
Owner Name: _____ Prepared By: _____	
Address: _____ Date: _____	
Property Location: _____	
<b>Constants</b>	<b>Summary of Loads</b>
$\gamma_w$ = specific weight of water = 62.4 lb/ft <sup>3</sup> for fresh water and 64.0 lb/ft <sup>3</sup> for saltwater	$f_{sta}$ = _____
<b>Variables</b>	$f_{dif}$ = _____
$H$ = floodproofing design depth (ft) = _____	$f_{comb}$ = _____
$D$ = depth of saturated soil (ft) = _____	$F_{buoy}$ = _____
$S$ = equivalent fluid weight of saturated soil (lb/ft <sup>3</sup> ) = _____	
$Vol$ = volume of floodwater displaced by a submerged object (ft <sup>3</sup> ) = _____	
<b>Lateral Hydrostatic Force (see Equation 4-4)</b>	
$f_{sta} = \frac{1}{2} P_b H = \frac{1}{2} \gamma_w H^2$	
<b>Submerged Soil and Water Forces (see Equation 4-5)</b>	
$f_{dif} = \frac{1}{2} (S - \gamma_w) D^2$	
<b>Buoyancy Force (see Equation 4-6)</b>	
$F_{buoy} = \gamma_w (Vol)$	

Note: Equations 4-4 and 4-5 do not account for equivalent hydrostatic loads due to the low velocity of floodwaters (less than 10 ft/sec). If velocity floodwater exists, use Equations 4-7 and 4-8. Refer to Chapter 8 of FEMA P-55, *Coastal Construction Manual* (FEMA, 2011) for discussion of hydrostatic loads.

Figure 4-9. Hydrostatic Force Computation Worksheet



## 4.1.2.7 Hydrodynamic Forces

When floodwater flows around a structure, it imposes additional loads on the structure, as shown in Figure 4-10. These loads are a function of flow velocity and structural geometry.

Low velocity hydrodynamic forces are defined as situations where floodwater velocities do not exceed 10 ft/sec, while high velocity hydrodynamic forces involve floodwater velocities in excess of 10 ft/sec.



## NOTE

Hydrodynamic forces have been shown to act on slab-on-grade houses to maximize their effects.

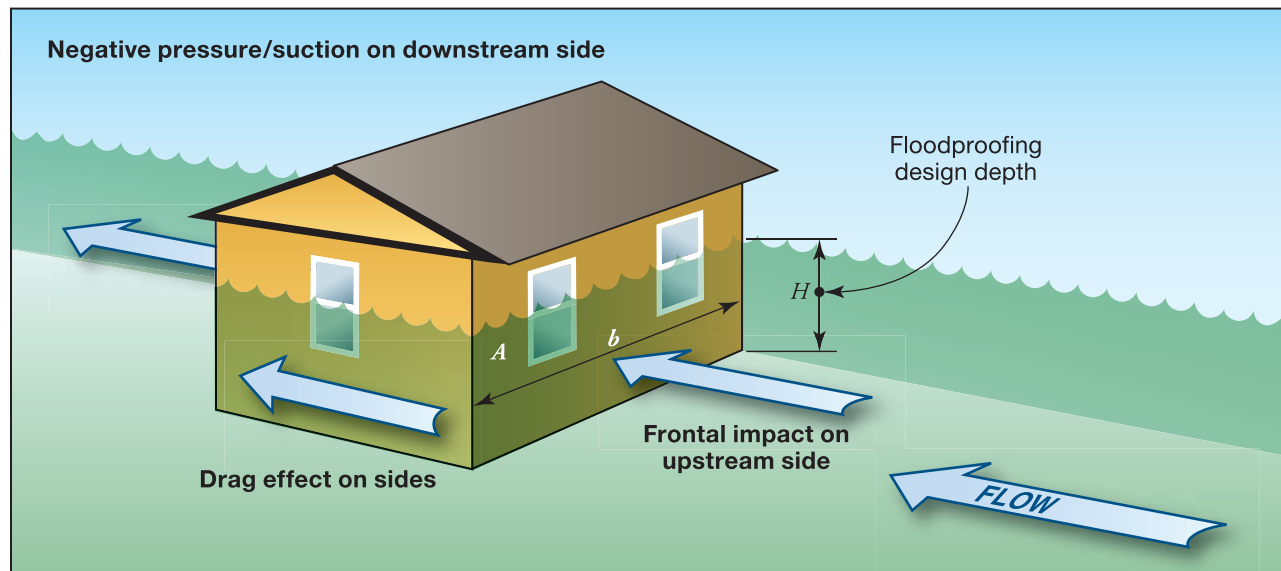

Figure 4-10. Hydrodynamic and impact forces

## Low Velocity Hydrodynamic Forces

In cases where velocities do not exceed 10 ft/sec, the hydrodynamic effects of moving water can be converted to an equivalent hydrostatic force by increasing the depth of the water (head) above the flood level by an amount  $dh$ , which is shown in Equation 4-7.

The drag coefficient used in Equation 4-7 is taken from the *Shore Protection Manual, Volume 2* (USACE, 1984) and additional guidance is provided in ASCE 7. The drag coefficient is a function of the shape of the object around which flow is directed. The value of  $C_d$ , unless otherwise evaluated, shall not be less than 1.25 and can be determined from the width-to-height ratio,  $b/H$ , of the structure in question. The width ( $b$ ) is the length of the side perpendicular to the flow, and the height ( $H$ ) is the distance from the floodproofing design depth to the LAG level. Table 4-5 gives  $C_d$  values for different width-to-height ratios.



## NOTE

Sources of data for determining flood flow velocity include hydraulic calculations, historical measurements, and rules of thumb. Floodwater that is 1 foot deep moving in excess of 5 ft/sec can knock an adult over and cause erosion of stream banks. Overbank velocities are usually less than stream channel velocities. If no data for flood flow velocity exists for a site, the reader should contact an experienced hydrologist or hydraulic engineer for estimates.



**EQUATION 4-7: CONVERSION OF LOW VELOCITY FLOW TO EQUIVALENT HEAD**

$$dh = \frac{C_d V^2}{2g} \tag{Eq. 4-7}$$

where:

- $dh$  = equivalent head due to low velocity flood flows (ft)
- $C_d$  = drag coefficient (from Table 4-5)
- $V$  = velocity of floodwater (ft/sec)
- $g$  = acceleration of gravity (equal to 32.2 ft/sec<sup>2</sup>)

Table 4-5. Drag Coefficients for Ratios of Width to Height (w/h)

Width to Height Ratio ( $b/H$ )	Drag Coefficient ( $C_d$ )
1-12	1.25
13-20	1.3
21-32	1.4
33-40	1.5
41-80	1.75
81-120	1.8
>120	2.0

The value  $dh$  is then converted to an equivalent hydrostatic pressure through use of the basic equation for lateral hydrostatic forces introduced earlier in this chapter and modified, as shown in Equation 4-8.



**EQUATION 4-8: CONVERSION OF EQUIVALENT HEAD TO EQUIVALENT HYDROSTATIC FORCE**

$$f_{dh} = \gamma_w (dh)H = P_{dh}H \tag{Eq. 4-8}$$

where:

- $f_{dh}$  = equivalent hydrostatic force due to low velocity flood flows (lb/lf)
- $\gamma_w$  = specific weight of water (62.4 lb/ft<sup>3</sup> for fresh water and 64.0 lb/ft<sup>3</sup> for saltwater)
- $dh$  = equivalent head due to low velocity flood flows (ft)
- $H$  = floodproofing design depth (ft)
- $P_{dh}$  = hydrostatic pressure due to low velocity flood flows (lb/ft<sup>2</sup>) ( $P_{dh} = \gamma_w(dh)$ )

**EQUATION 4-8:  
CONVERSION OF EQUIVALENT HEAD TO EQUIVALENT HYDROSTATIC FORCE**

(concluded)

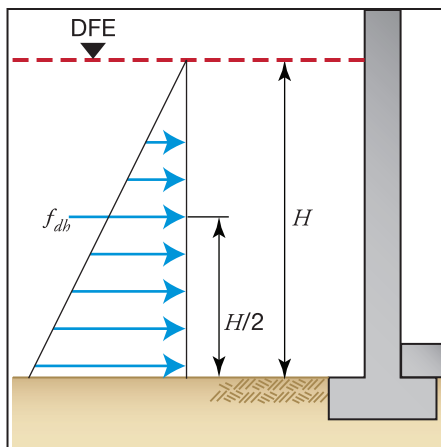
**NOTE**

Although  $f_{db}$  is considered a hydrostatic force for velocities under 10 ft/sec, it acts at a point  $H/2$ , similarly to lateral hydrodynamic forces.

Equivalent Hydrostatic Force Computation Worksheet	
Owner Name: _____	Prepared By: _____
Address: _____	Date: _____
Property Location: _____	
<b>Constants</b>	
$\gamma_w$ = specific weight of water = 62.4 lb/ft <sup>3</sup> for fresh water and 64.0 lb/ft <sup>3</sup> for saltwater	
$g$ = acceleration of gravity = 32.2 ft/sec <sup>2</sup>	
<b>Variables</b>	
$H$ = design floodproof depth (ft) =	
$V$ = velocity of floodwater (10 ft/sec or less) =	
$P_{db}$ = hydrostatic pressure due to low velocity flood flows (lb/ft <sup>2</sup> ) =	
$b$ = width of structure perpendicular to flow (ft) =	
<b>Summary of Loads</b>	
$f_{db}$ =	
$f_{sta}$ =	
$f_{dif}$ =	
$f_{comb}$ =	
Conversion of Low Velocity Flood Flow to Equivalent Head (see Equation 4-7)	
$f_{db} = \gamma_w (db)H = P_{db} H$	
Develop $C_d$ :	
$b/H =$	
From Table 4-5; $C_d =$	
Conversion of Equivalent Head to Equivalent Hydrostatic Force (see Equation 4-8)	
$P_d = C_d \rho \frac{V^2}{2}$	

Figure 4-11. Equivalent Hydrostatic Force Computation Worksheet

### 4.1.2.8 High Velocity Hydrodynamic Forces

For special structures and conditions, and for velocities greater than 10 ft/sec, a more detailed analysis and evaluation should be made utilizing basic concepts of fluid mechanics and/or hydraulic models. The basic equation for hydrodynamic pressure is shown in Equation 4-9.



#### EQUATION 4-9: HIGH VELOCITY HYDRODYNAMIC PRESSURE

$$P_d = C_d \rho \frac{V^2}{2} \quad (\text{Eq. 4-9})$$

where:

$P_d$  = hydrodynamic pressure (lb/ft<sup>2</sup>)

$C_d$  = drag coefficient (taken from Table 4-5)

$\rho$  = mass density of fluid (1.94 slugs/ft<sup>3</sup> for fresh water and 1.99 slugs/ft<sup>3</sup> for saltwater)

$V$  = velocity of floodwater (ft/sec)

After determination of the hydrodynamic pressure ( $P_d$ ), the total force ( $F_d$ ) against the structure (see Figure 4-10) can be computed as the pressure times the area over which the water is affecting (see Equation 4-10).



#### EQUATION 4-10: TOTAL HYDRODYNAMIC FORCE

$$F_d = P_d A \quad (\text{Eq. 4-10})$$

where:

$F_d$  = total force against the structure (lb)

$P_d$  = hydrodynamic pressure (lb/ft<sup>2</sup>)

$A$  = submerged area of the upstream face of the structure (ft<sup>2</sup>)

Figure 4-12 can be used in the computation of high velocity hydrodynamic forces.

Hydrodynamic Force (High Velocity) Computation Worksheet	
Owner Name: _____	Prepared By: _____
Address: _____	Date: _____
Property Location: _____	
<b>Constants</b>	<b>Summary of Loads</b>
$\rho$ = mass density of fluid (1.94 slugs/ft <sup>3</sup> for fresh water and 1.99 slugs/ft <sup>3</sup> for saltwater)	$P_d$ =
	$F_d$ =
<b>Variables</b>	
$V$ = velocity of floodwater, >10 ft/sec =	
$C_d$ = drag coefficient =	
$A$ = submerged area of upstream face of structure (ft <sup>2</sup> ) =	
High Velocity Hydrodynamic Pressure (see Equation 4-9)	
$P_d = C_d \rho \frac{V^2}{2}$ <p>Develop <math>C_d</math>:</p> $b/H =$ <p>From Table 4-5; <math>C_d =</math></p>	
Total Hydrodynamic Force (see Equation 4-10)	
$F_d = P_d A$	

Figure 4-12. Hydrodynamic Force (High Velocity) Computation Worksheet

### 4.1.2.9 Impact Loads

Impact loads are imposed on the structure by objects carried by the moving water. The magnitude of these loads is very difficult to predict, but some reasonable allowance must be made for them in the design of retrofitting measures for potentially affected buildings. To arrive at a realistic allowance, considerable judgment must be used, along with the designer’s knowledge of debris problems at the site and consideration of the degree of exposure of the structure. Impact loads are classified as:

- no impact (for areas of little or no velocity or potential source of debris);
- normal impact;
- special impact; and
- extreme impact.



#### CROSS REFERENCE

Section 5.4.5 of ASCE 7-10 and the corresponding commentary contain an extensive discussion on computing riverine and coastal impact loads.



### Normal Impact Forces

Normal impact forces relate to isolated occurrences of typically sized debris or floating objects striking the structure (see Figure 4-10 for location of frontal impact from debris). For design purposes, this can be considered a concentrated load acting horizontally at the flood elevation, or any point below it, equal to the impact force created by a typical object traveling at the velocity of the floodwater acting on a 1-square-foot surface of the submerged structure area perpendicular to the flow. Typical object size and mass will vary by location, but ASCE 7-10 *Commentary*, section C5.4.5 (Debris Weight), provides some guidance. The calculation of normal impact forces (loads) is shown in Equation 4-11.

The equation for calculating debris loads is given in the ASCE 7, *Commentary*. The equation has been converted into Equation 4-11, based on assumptions appropriate for the typical structures that are covered in this document.



#### NOTE

The assumption that debris velocity is equal to the flood velocity may overstate the velocities of large debris objects; therefore, engineering judgment may be required in some instances. Designers may wish to reduce debris velocity for larger objects.



#### EQUATION 4-11: NORMAL IMPACT LOADS

$$F_i = W V C_D C_B C_{Str} \quad (\text{Eq. 4-11})$$

where:

- $F_i$  = impact force acting at the BFE (lb)
- $W$  = weight of the object (lb)
- $V$  = velocity of water (ft/sec)
- $C_D$  = depth coefficient (see Table 4-6)
- $C_B$  = blockage coefficient (taken as 1.0 for no upstream screening, flow path greater than 30 ft; see Table 4-7 for more information)
- $C_{Str}$  = building structure coefficient
  - = 0.2 for timber pile and masonry column supported structures 3 stories or less in height above grade
  - = 0.4 for concrete pile or concrete or steel moment resisting frames 3 stories or less in height above grade
  - = 0.8 for reinforced concrete (including insulated concrete) and reinforced masonry foundation walls

Table 4-6. Depth Coefficient ( $C_D$ ) by Flood Hazard Zone and Water Depth

Flood Hazard Zone and Water Depth	$C_D$
Floodway <sup>1</sup> or Zone V	1.0
Zone A, stillwater flood depth > 5 ft	1.0
Zone A, stillwater flood depth = 4 ft	0.75
Zone A, stillwater flood depth = 3 ft	0.5
Zone A, stillwater flood depth = 2 ft	0.25
Zone A, stillwater flood depth < 1 ft	0.0

<sup>1</sup> Per ASCE 24, a “floodway” is a “channel and that portion of the floodplain reserved to convey the base flood without cumulatively increasing the water surface elevation more than a designated height.”

Table 4-7. Values of Blockage Coefficient ( $C_B$ )

Degree of Screening or Sheltering within 100 ft Upstream	$C_B$
No upstream screening, flow path wider than 30 ft	1.0
Limited upstream screening, flow path 20 ft wide	0.6
Moderate upstream screening, flow path 10 ft wide	0.2
Dense upstream screening, flow path less than 5 ft wide	0.0

Often, there are regional differences between the size, shape, and weight of water-borne debris, and the debris velocity. Designers should consider locally adopted guidance because it may be based on more recent information or information specific to the local hazards than the information in ASCE 7.

The parameters in Equation 4-11 are also discussed in detail in Chapter 8 of FEMA P-55, *Coastal Construction Manual* (FEMA, 2011, Fourth Edition).

### Special and Extreme Impact Forces

Special impact forces occur when large objects or conglomerates of floating objects, such as ice floes or accumulations of floating debris, strike a structure. Where stable natural or artificial barriers exist that would effectively prevent these special impact forces from occurring, these forces may not need to be considered in the design. Details for calculating special impact loads are outlined in the ASCE 7 commentary section C5.4.5.



#### NOTE

Where extreme impact loads are a threat, the preferred retrofitting alternative is relocation.

Extreme impact forces occur when large, floating objects, such as runaway barges or collapsed buildings and structures, strike the structure (or a component of the structure). These forces generally occur within the floodway or areas of the floodplain that experience the highest velocity flows. It is impractical to design residential buildings to have adequate strength to resist extreme impact forces.

Impact forces are critical design considerations that must be thoroughly evaluated. The following Impact Force Computation Worksheet, Figure 4-13, can be used to conduct normal impact force calculations.

Impact Force Computation Worksheet	
Owner Name: _____	Prepared By: _____
Address: _____	Date: _____
Property Location: _____	
<b>Variables</b>	
$W$ = weight of the object (lb)	
$V$ = velocity of water (ft/sec)	
$C_D$ = depth coefficient (see Table 4-6)	
$C_B$ = blockage coefficient (taken as 1.0 for no upstream screening, flow path greater than 30 ft; see Table 4-7 for more information)	
$C_{Str}$ = building structure coefficient	
= 0.2 for timber pile and masonry column supported structures 3 stories or less in height above grade	
= 0.4 for concrete pile or concrete or steel moment resisting frames 3 stories or less in height above grade	
= 0.8 for reinforced concrete foundation walls (including insulated concrete forms)	
<b>Summary of Loads</b>	
$F_i$ =	
Normal Impact Loads (see Equation 4-11)	
$F_i = W V C_D C_B C_{Str}$	

Figure 4-13. Impact Force Computation Worksheet

#### 4.1.2.10 Riverine Erosion

The analysis of erosion that impacts stream banks and nearby overbank structures is a detailed effort that is usually accompanied by detailed geotechnical investigations. Some of the variables that impact the stability (or erodibility) of the stream banks include the following:

- critical height of the slope;
- inclination of the slope;
- cohesive strength of the soil in the slope;
- distance of the structure in question from the shoulder of the stream bank;
- degree of stabilization of the surface of the slope;



#### CROSS REFERENCE

1- to 24-hour rainfall intensities for each State are available from the National Weather Service (NWS) *Technical Memorandum NWS HYDRO-35*, “Technical Paper 40, NOAA Atlas 2” or “NOAA Atlas 14” available for download at: <http://www.nws.noaa.gov/oh/hdsc/currentpf.htm>.

Rainfall intensities are available for a range of storm frequencies, including the 2-, 10-, 25-, 50-, and 100-year events. The 2- or 10-year intensity rainfall is considered a minimum design value for pumping rates when floodwater prevents gravity discharge from floodwalls and levees. The 100-year intensity rainfall should be the maximum design value for sizing gravity flow pipes and/or closures.

- level and variation of groundwater within the slope;
- level and variation in level of water on the toe of the slope;
- tractive shear stress of the soil; and
- frequency of rise and fall of the surface of the stream.

Both FEMA and the USACE have researched the stability of stream banks in an effort to quantify stream bank erosion. However, concerns over the universal applicability of the research results preclude their inclusion in this manual. It is suggested that, when dealing with stream banks susceptible to erosion, the designer contact a qualified geotechnical engineer or a hydraulic engineer experienced in channel stability.

### 4.1.3 Site Drainage

The drainage system for the area enclosed by a floodwall or levee must accommodate the precipitation runoff from this interior area (and any contributing areas such as roofs and higher ground parcels) and the anticipated seepage through or under the floodwall or levee during flooding conditions.

There are two general methods for removing interior drainage. The first is a gravity flow system, which provides a means for interior drainage of the protected area when there is no floodwater against the floodwall or levee. This is accomplished by placing a pipe(s) through the floodwall or levee with a flap gate attachment. The flap gate prevents flow from entering the interior area through the drainpipe when floodwater rises above the elevation of the pipe.

The second method, a pump system, removes accumulation of water when the elevation of the floodwater exceeds the elevation of the gravity drain system. A collection system composed of pervious trenches, underground tiles, or sloped surface areas transports the accumulating water to a sump area. In the levee application, these drains should be incorporated into the collection system. The anticipated seepage from under and through floodwalls and levees must also be taken into consideration by combining it with flow from precipitation (see Figure 4-14). It is important to verify that the pump system has a reliable power source that can handle the flooding in the area enclosed by the floodwall or levee. This is essential to the performance of the floodwall or levee system.

To determine the amount of precipitation that can collect in the contained area, the rainfall intensity, given in inches per hour, must be determined for a particular location. This value is multiplied by the enclosed area,  $A_a$ , in square feet, a residential terrain runoff coefficient ( $c$ ) of 0.7, and a conversion factor of 0.01. The answer is given in gallons per minute (gpm). See Equation 4-12.



#### NOTE

The rational equation  $Q = ci_r A$  is used to compute the amount of precipitation runoff from small areas. It is generally not applicable to drainage areas greater than 10 acres in size.



#### NOTE

The residential terrain runoff coefficient,  $c$ , is used to model the runoff characteristics of various land uses. Use the value for the predominant land use within a specific area or develop a weighted average for areas with multiple land uses. The most common coefficients are 0.70 for residential areas, 0.90, for commercial areas, and 0.40 for undeveloped land.

Figure 4-14. Rectangular area enclosed by a floodwall or levee

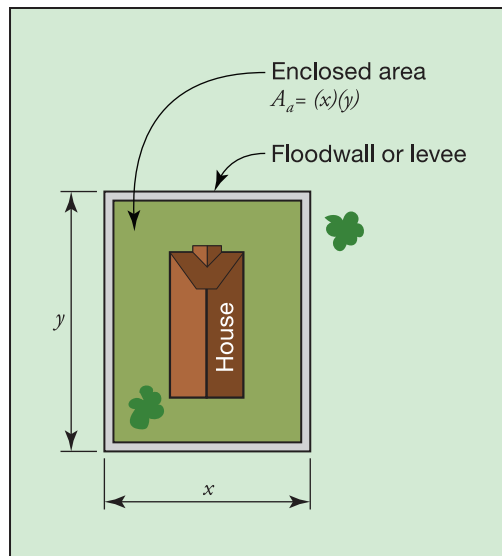

**EQUATION 4-12: RUNOFF QUANTITY IN AN ENCLOSED AREA**

$$Q_a = 0.01ci_r A_a \quad (\text{Eq. 4-12})$$

where:

- $Q_a$  = runoff from the enclosed area (gpm)
- 0.01 = factor converting the answer to gpm
- $c$  = residential terrain runoff coefficient of 0.7
- $i_r$  = intensity of rainfall (in./hr)
- $A_a$  = is the area enclosed by the floodwall or levee (ft<sup>2</sup>)

**NOTE**

When determining the minimum discharge size for pumps within enclosed areas, the designer should consider the impacts of lag time between storms that control the gravity flow mechanism (i.e., inside and outside the enclosed area) and the storage capacity within the enclosed area after the gravity discharge system closes. If the designer is not familiar with storm lag time and the computation of storage within an enclosed area, an experienced hydrologist or hydraulic engineer should be consulted.

In some cases, a levee or floodwall may extend only partially around the property and tie into higher ground (see Figure 4-15). For such cases, the amount of precipitation that can flow downhill as runoff into the protected area,  $A_a$ , must be included. To calculate this value, the additional area of land,  $A_b$ , that can discharge water into the enclosure should be estimated. This value is then multiplied by the previously determined rainfall intensity,  $i_r$ , by the most suitable terrain coefficient, and by 0.01. See Equation 4-13.

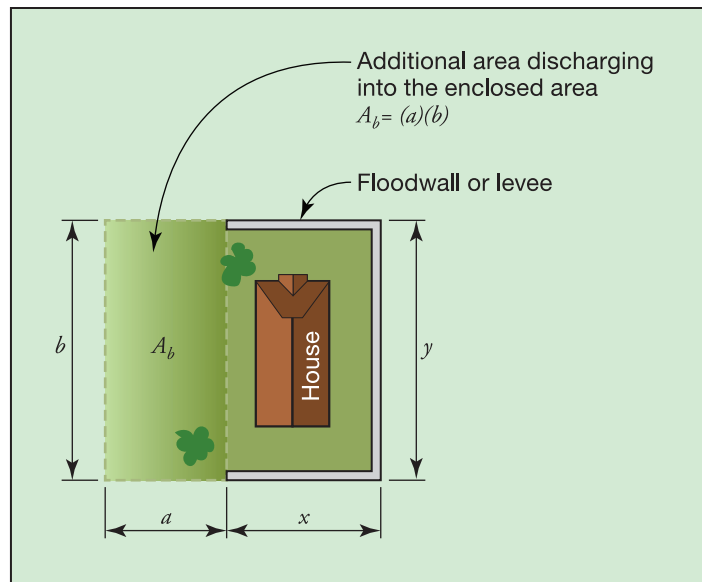

Figure 4-15.  
 Rectangular area partially enclosed by a floodwall or levee



**EQUATION 4-13:  
 RUNOFF QUANTITY FROM HIGHER GROUND INTO A PARTIALLY ENCLOSED AREA**

$$Q_b = 0.01ci_r A_b \quad (\text{Eq. 4-13})$$

where:

$Q_b$  = runoff from additional contributing area (gpm)

0.01 = factor converting the answer to gpm

$c$  = most suitable terrain runoff coefficient

$i_r$  = is the intensity of rainfall (in./hr)

$A_b$  = area discharging to the area partially enclosed by the floodwall or levee (ft<sup>2</sup>)

Seepage flow rates from the levee or floodwall,  $Q_c$ , must also be estimated. In general, unless the seepage rate is calculated by a qualified soils engineer, a value of 2 gpm for every 300 feet of levee or 1 gpm for every 300 feet of floodwall should be assumed during base 100-year-flood conditions. See Equation 4-14.





#### EQUATION 4-14: SEEPAGE FLOW RATE THROUGH A FLOODWALL OR LEVEE

$$Q_c = sr(l) \quad (\text{Eq. 4-14})$$

where:

$Q_c$  = seepage rate through the floodwall/levee (gpm)

$sr$  = seepage rate (gpm) per foot of floodwall/levee

$l$  = length of the floodwall/levee (ft)

The values for inflow within the enclosed area, runoff from uphill areas draining into the enclosure, and seepage through the floodwall/levee should be added together to obtain the minimum discharge size,  $Q_{sp}$ , in gpm for the pump. See Equation 4-15.



#### EQUATION 4-15: MINIMUM DISCHARGE FOR PUMP INSTALLATION

$$Q_{sp} = Q_a + Q_b + Q_c \quad (\text{Eq. 4-15})$$

where:

$Q_{sp}$  = minimum discharge for pump installation (gpm)

$Q_a$  = discharge from an enclosed area (from Equation 4-14) (gpm)

$Q_b$  = discharge from higher ground to partially enclosed area (from Equation 4-15) (gpm)

$Q_c$  = discharge from seepage through a floodwall or levee (from Equation 4-16) (gpm)

Important considerations in determining the minimum discharge size of a pump include storage available within the enclosed area and the lag time between storms that impact the enclosed area and the area to which the enclosed area drains. Pumps will continue to operate during flooding events (assuming power is constant or backup power is available), but gravity drains will close once the floodwater elevation outside of the enclosed area exceeds the elevation of the drain pipe/flap gate. Therefore, the critical design issue is to determine runoff and seepage that occurs once the flap gate closes. Typical design solutions incorporate a freeboard of several inches or more to safely control the 10-year flood event.

Figure 4-16 can be used to calculate the minimum discharge for pump installations.

Interior Drainage Computation Worksheet	
Owner Name: _____	Prepared By: _____
Address: _____	Date: _____
Property Location: _____	
<b>Constants</b>	
0.01 = factor converting the answer to gpm	
<b>Variables</b>	
$A_a$ = is the area enclosed by the floodwall or levee (ft <sup>2</sup> )	
$A_b$ = area discharging to the area partially enclosed by the floodwall or levee (ft <sup>2</sup> )	
$c$ = residential terrain runoff coefficient of 0.7	
$i_r$ = intensity of rainfall (in./hr)	
$sr$ = seepage rate (gpm) per foot of floodwall/levee	
$l$ = length of the floodwall/levee (ft)	
<b>Summary of Loads</b>	
$Q_{sp}$ =	
$Q_a$ =	
$Q_b$ =	
$Q_c$ =	
Runoff Quantity in an Enclosed Area (see Equation 4-12)	
$Q_a = 0.01ci_rA_a$	
Runoff Quantity From Higher Ground into a Partially Enclosed Area (see Equation 4-13)	
$Q_b = 0.01ci_rA_b$	
Seepage Flow Rate Through a Levee or Floodwall (see Equation 4-14)	
$Q_c = sr(l)$	
Minimum Discharge for Pump Installation (see Equation 4-15)	
$Q_{sp} = Q_a + Q_b + Q_c$	

Figure 4-16. Interior Drainage Computation Worksheet

#### 4.1.3.1 Closed Basin Lakes

Two types of lakes pose special hazards to adjacent development: lakes with no outlets, such as the Great Salt Lake and the Salton Sea (California); and lakes with inadequate or elevated outlets, such as the Great Lakes and many glacial lakes. These two types are referred to as “closed basin lakes.” Closed basin lakes are subject to very large fluctuations in elevation and can retain persistent high water levels.

Closed basin lakes occur in almost every part of the United States for a variety of reasons: lakes in the northern tier of States and Alaska were scoured out by glaciers; lakes with no outlets (playas) formed in the west due to tectonic action; oxbow lakes along the Mississippi and other large rivers formed as a result of channel migration; and sinkhole lakes form in areas with large limestone deposits at or near the surface where there is adequate surface water and rainfall to dissolve the limestone (Karst topography).

Determination of the flood elevations for closed basin lakes follows generally accepted hydrological methods, which incorporate statistical data, historical high water mark determinations, stage-frequency analysis, topographical analysis, water balance analysis, and combinations of these methods. The flood-prone area around a closed basin lake is referred to in affected DFIRM panels as an Area of Special Consideration (ASC). The ASC may include the 1- and 0.2-percent-annual-chance floodplains and additional areas to account for the continuous and often uncertain fluctuations in the water-surface elevation due to the closed-basin lake phenomenon. The ASC is an area subject to flooding, but the percent chance of being flooded in any given year is not defined.



### CROSS REFERENCE

More information on closed basin lakes, alluvial fan, and movable bed stream hazards can be obtained from the *National Flood Insurance Program Community Rating System, Special Hazards Supplement to the CRS Coordinator's Manual* (FEMA, 2006b).

#### 4.1.4 Movable Bed Streams

Erosion and sedimentation are factors in the delineation and regulation of almost all riverine floodplains. In many rivers and streams, these processes are relatively predictable and steady. In other streams, sedimentation and erosion are continual processes, often having a larger impact on the extent of flooding and flood damages than the peak flow.

Extreme cases of sedimentation and erosion are a result of both natural and engineered processes. They frequently occur in the arid west, where relatively recent tectonic activity has left steep slopes, rainfall and streamflow are infrequent, and recent and rapid development has disturbed the natural processes of sediment production and transport.

Movable bed streams include streams where erosion (degradation of the streambed), sedimentation (aggradation of the streambed), or channel migration cause a change in the topography of the stream sufficient to change the flood elevation or the delineation of the floodplain or floodway. Analysis of movable bed streams generally includes a study of the sources of sediment, changes in those sources, and the impact of sediment transport through the floodplain.

#### 4.1.5 Analysis of Non-Flood-Related Hazards

While floods continue to be a major hazard to homes nationwide, they are not the only natural hazard that causes damage to residential buildings. Parts of the United States are subject to high winds that can accompany thunderstorms, hurricanes, tornadoes, and frontal passages. In addition, many regions are threatened by earthquake fault areas, land subsidence, and fire and snow hazards (Figure 4-17).

Retrofitting measures can be designed to modify structures to reduce the chance of damage from wind and other non-flood-related hazards. Fortunately, strengthening a home to resist earthquake damage can also increase its ability to withstand wind damage and flood-related impact and velocity forces.

Non-Flood-Related Hazards
Wind forces
Seismic forces
Land subsidence

Figure 4-17.  
Non-flood-related  
natural hazards

### 4.1.6 Wind Forces

High winds impose significant forces on a home and the structural elements of its foundation. Damage potential is increased when the wind forces occur in combination with flood forces, often in coastal areas. In addition, as a structure is elevated to minimize the effects of flood forces, the wind loads on the elevated structure may be increased, depending on the amount of elevation and the structure's exposure to wind forces.

Wind forces exert pressure on structural components such as walls, roofs, connections, and foundations. Therefore, wind loads should be considered in the design process at the same time as hydrostatic, hydrodynamic, impact, and building dead and live loads, and loads from other natural hazards such as earthquakes.

A detailed discussion for computation of wind forces is beyond the scope of this publication. However, FEMA P-55, *Coastal Construction Manual*, (FEMA, 2011) provides details on the basic parameters for determining wind loads:

- basic wind speed (see ASCE 7 or IRC wind speed map,  $V$ );
- wind directionality factor,  $K_d$  (see ASCE 7);
- building exposure category, B, C, or D (see ASCE 7);
- topographic factor,  $K_{zt}$  (see ASCE 7);
- gust effect factor, typically 0.85 (see ASCE 7);
- enclosure classification, open, partially enclosed, or enclosed (see ASCE 7); and
- internal pressure coefficient,  $GC_{pi}$  (see ASCE 7).

When wind interacts with a building, both positive and negative pressures simultaneously occur (see Figure 4-18). To prevent wind induced building failure, buildings must have sufficient strength to resist the applied loads from these pressures. As previously mentioned, the magnitude of pressure is a function of several primary factors: exposure, basic wind speed, topography, building height, building shape, and internal



#### NOTE

The designer must be aware that retrofitting actions may trigger a threat from multiple natural hazards and be prepared to address these issues.



#### CROSS REFERENCE

Refer to FEMA P-55, *Coastal Construction Manual* (FEMA, 2011), and ASCE 7 for a detailed discussion of wind forces.

Figure 4-18.  
Wind-induced pressures on a building

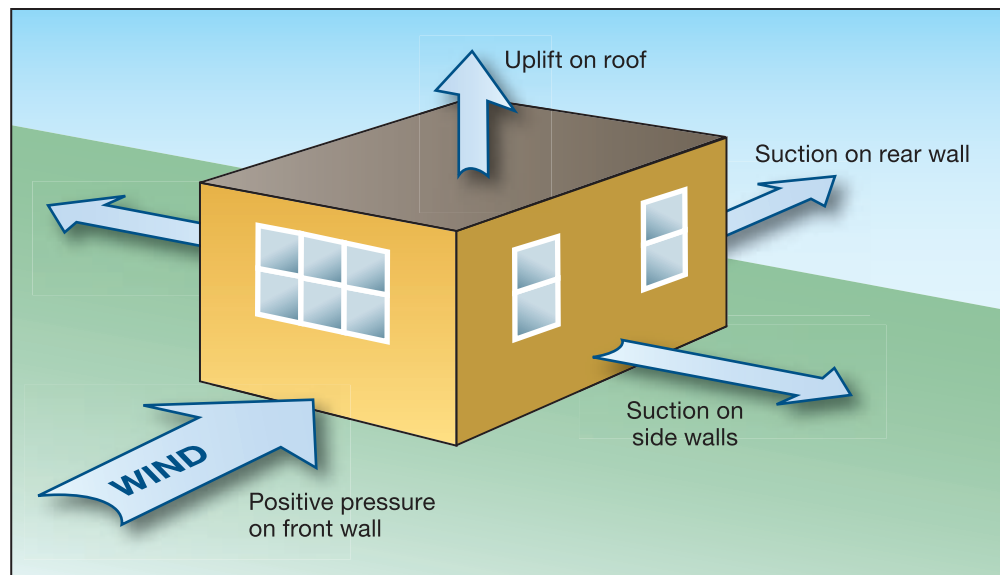

pressure classification. Once these parameters are defined, the engineer can determine the design pressures, and apply these pressures to the appropriate tributary area for the element or connection to be analyzed.

The concept of wind producing significant forces on a structure is based on the velocity difference of a medium (air) striking an obstruction (the structure). Wind speeds vary, depending on the location within the United States and the frequency with which these loads occur. ASCE 7 and the IRC provide basic wind speed maps showing these wind velocities and frequencies. The design velocity for a particular site can be determined from these maps. If the local code enforced is the IRC, the designer should refer to the IRC wind speed maps (Figures 4-19 A and B). If no local code is in force, the designer should refer to ASCE 7, *Minimum Design Loads for Buildings and Other Structures*.

FEMA has completed several building performance assessments following Hurricanes, including Andrew (1992), Iniki (1992), Opal (1995), Fran (1996), Georges (1998), Ivan (2004), Charley (2004), Katrina (2005), and Ike (2008). FEMA assessed the structural performance of residential building systems damaged by hurricane winds; provided findings and recommendations for enhancing building performance under hurricane wind conditions; and addressed building materials, code compliance, plan review, construction techniques, quality of construction, and construction inspection issues.



### CROSS REFERENCE

Copies of the building performance assessment reports can be obtained from the FEMA library: <http://www.fema.gov/library>

FEMA 488, *Hurricane Charley in Florida – Observations, Recommendations, and Technical Guidance*, 2005

FEMA 489, *Hurricane Ivan in Alabama and Florida – Observations, Recommendations, and Technical Guidance*, 2005

FEMA 549, *Hurricane Katrina in the Gulf Coast – Building Performance Observations, Recommendations, and Technical Guidance*, 2006

FEMA P-757, *Hurricane Ike in Texas and Louisiana – Building Performance Observations, Recommendations, and Technical Guidance*, 2009

FEMA P-765, *Midwest Floods of 2008 in Iowa and Wisconsin – Building Performance Observations, Recommendations, and Technical Guidance*, 2009

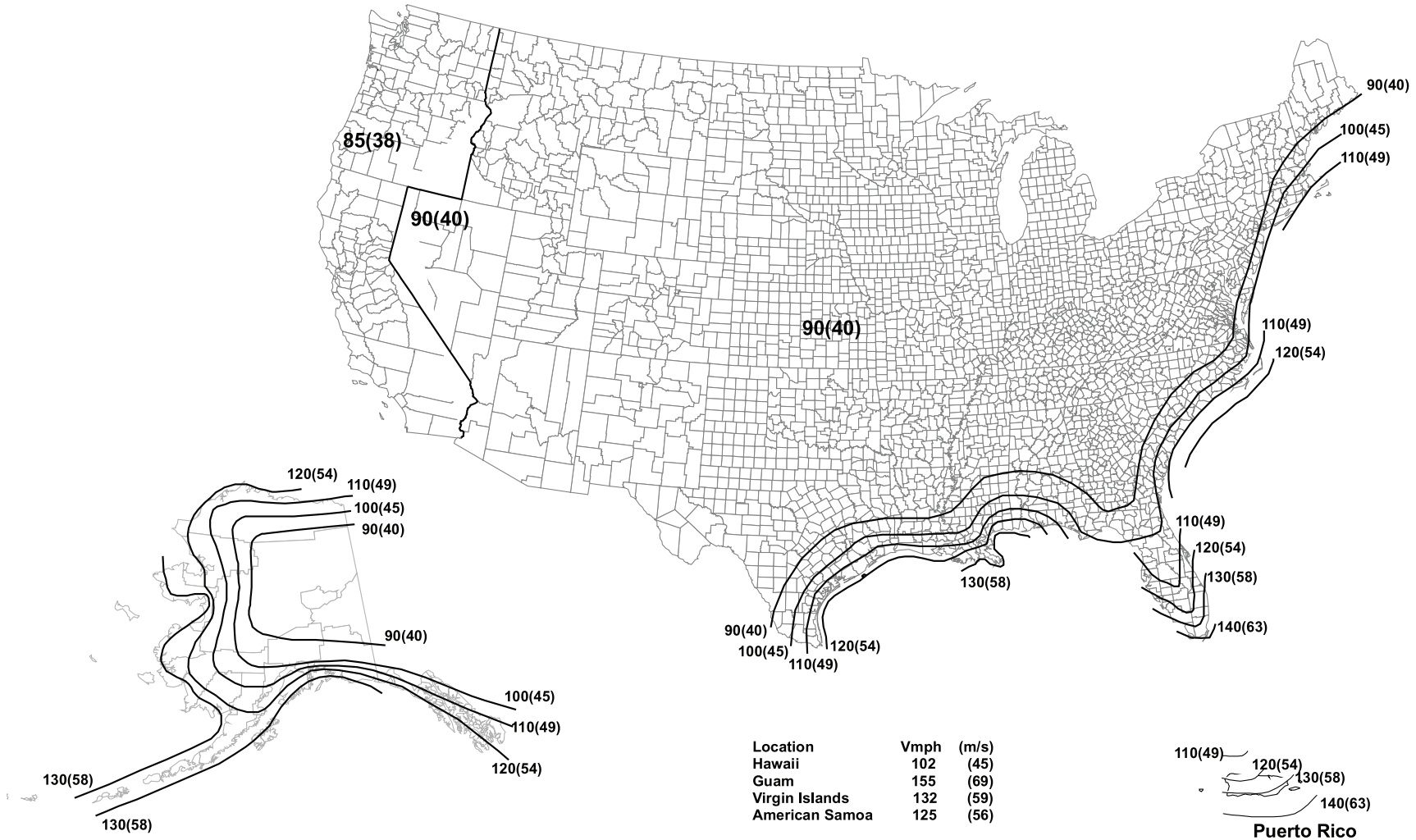

**Notes:**

1. Values are nominal design 3-second gust wind speeds in miles per hour (m/s) at 33 ft (10 m) above ground for Exposure C category.
2. Linear interpolation between contours is permitted.
3. Islands and coastal areas outside the last contour shall use the last wind speed contour of the coastal area.
4. Mountainous terrain, gorges, ocean promontories, and special wind regions shall be examined for unusual wind conditions.

Figure 4-19A. Basic wind speed map

SOURCE: IRC, USED WITH PERMISSION



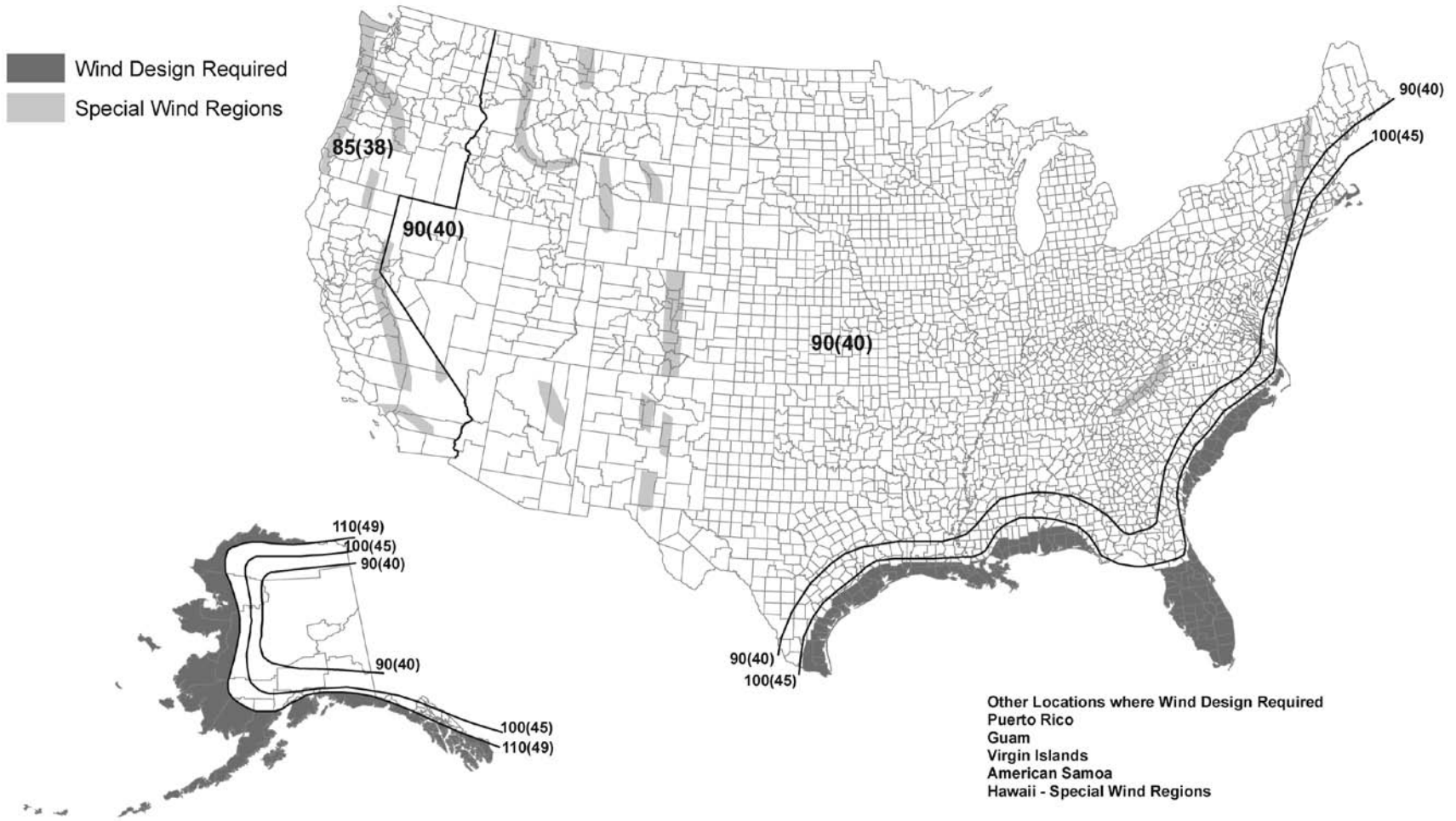

Figure 4-19B. Regions where wind design is required

SOURCE: IRC, USED WITH PERMISSION

These reports present detailed engineering discussions of building failure modes along with successful building performance guidance supplemented with design sketches. Please refer to these documents for specific engineering recommendations.

### 4.1.7 Seismic Forces

Seismic forces on a home and the structural elements of a foundation can be significant. Seismic forces may also trigger additional hazards such as landslides and soil liquefaction, which can increase the damage potential on a home. These forces act on structural components such as walls, roofs, connections, and foundations. Similar to wind forces, seismic forces should be considered in the design process at the same time as hydrostatic, hydrodynamic, impact, and building dead and live loads, and loads from other natural hazards such as hurricanes. Requirements for seismic design are normally available in locally adopted building codes. Requirements in ASCE 7 and model building codes such as the IBC are often the basis of seismic requirements contained in locally adopted building codes.

Figures 4-20 and 4-21 illustrate steps of a seismic design process that includes estimating seismic loads and determining the ability of existing structural components to withstand these loads.

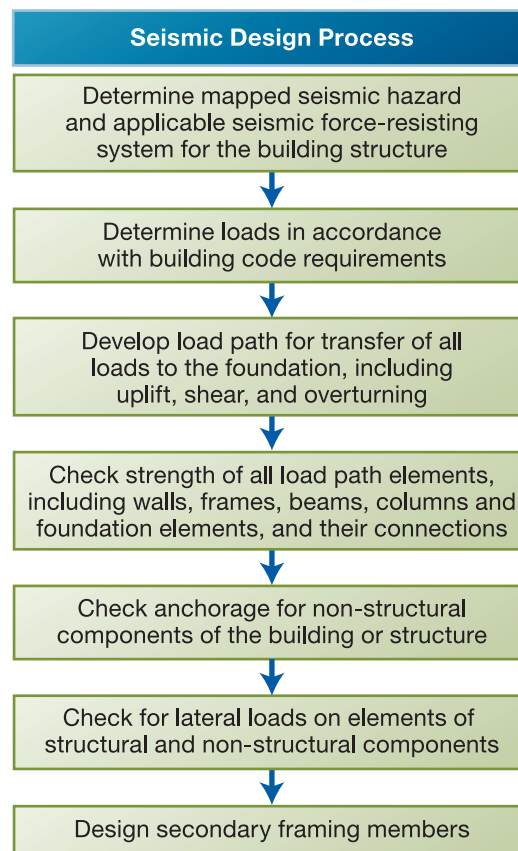

Figure 4-20.  
Seismic design process

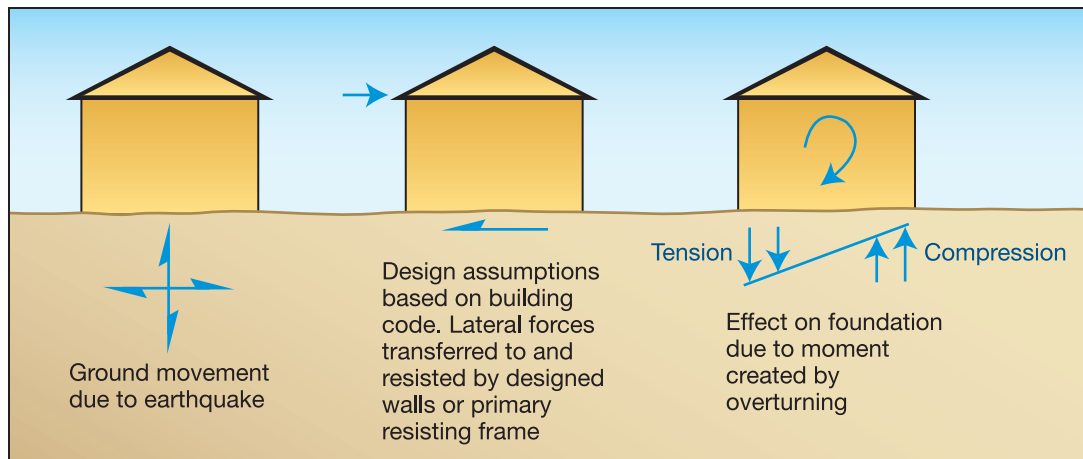

Figure 4-21. Seismic design causes and effects

When making repairs to a flood-damaged home or considering retrofitting structures to minimize the impact of future flooding events, there are certain practical steps that can be taken at the same time to reduce the chance of damage from other hazards. Earthquake protection steps can be divided into two categories: steps that deal with the building structure itself, and steps that can be taken with other non-structural parts of the building and its contents.

### 4.1.8 Combining Forces

Flood-related and non-flood-related forces need to be evaluated using applicable load combinations. Analysis of load combinations is covered in detail in Chapter 5 and ASCE 7.

### 4.1.9 Protection of the Structure

For protection of the building structure, the most important step is making sure the home is properly designed and constructed for seismic events. This includes proper design of the foundation and anchoring to the foundation. An engineered design will generally be required when the foundation of the house is raised above the BFE and the foundation is being considered to ensure the entire structure can withstand seismic forces.



#### CROSS REFERENCE

If provisions of the local code do not address seismic loads or if a local code is not adopted for use, the designer should refer to the ASCE 7, *Minimum Design Loads for Buildings and Other Structures* or requirements of the International Building Code.



#### CROSS REFERENCE

Refer to Section 5.2 for a detailed discussion of load combination scenarios and design methods.



#### CROSS REFERENCE

Additional information concerning the determination of flood-related forces is available in the flood design load criteria incorporated in Section 5 of ASCE 7, *Minimum Design Loads for Buildings and Other Structures*, and ASCE 24, *Flood Resistant Design and Construction*.

Key portions of masonry block foundations usually require strengthening by installing reinforcing bars in the blocks and then filling them with concrete grout. FEMA has developed a sample plan for strengthening a masonry block foundation wall. This type of work can be complicated and normally requires the expertise of a design professional such as an engineer or architect.

FEMA's *Technical Information on Elevating Substantially Damaged Residential Buildings in the Midwest* (1993d) provides procedures for determining seismic forces and recommendations for seismic retrofitting of a wood-frame structure. For more information on protecting a structure from seismic hazards, contact the appropriate FEMA Regional Office's Mitigation Division.



#### CROSS REFERENCE

The additional cost for seismic strengthening was estimated by FEMA (during the Midwest Floods of 1993) to range from 17-23 percent of the base repair cost for elevating a 1,000-square foot wood-frame structure on masonry foundation walls. FEMA prepared a methodology to estimate the costs of seismic retrofit projects described in FEMA 156, *Typical Costs for Seismic Rehabilitation of Existing Buildings* (FEMA, 1994).

### 4.1.10 Protection of Non-Structural Building Components and Building Contents

For non-structural building components and contents, earthquake protection usually involves simpler activities that homeowners can undertake themselves. These include anchoring and bracing of fixtures, appliances (e.g., hot water heaters and furnaces), chimneys, tanks, cabinets, shelves, and other items that may tip over or become damaged when subjected to earthquake ground shaking.

### 4.1.11 Land Subsidence

Subsidence of the land surface affects flooding and flood damages. It occurs in more than 17,000 square miles in 45 States and an area roughly the size of New Hampshire and Vermont combined. In 1991, the National Research Council estimated that annual costs in the United States from flooding and structural damage caused by land subsidence exceeded \$125 million. Because the causes of subsidence vary, selected mitigation techniques are required in different situations.

Subsidence may result in sudden, catastrophic collapses of the land surface or in a slow lowering of the land surface. In either case, it can cause increased hazards to structures and infrastructure. In some cases, the causes of subsidence can be controlled.

Subsidence is typically a function of withdrawal of fluids or gases, the existence of organic soils, or other geotechnical factors; it requires an extensive engineering/geotechnical analysis. While NFIP regulations do not specifically address land subsidence, communities that develop mapping and regulatory standards addressing these hazards may receive flood insurance premium credits through the NFIP CRS. The designer should determine if a local community has mapped or enacted an ordinance covering this special hazard.



#### CROSS REFERENCE

More information on land subsidence hazards can be obtained from the *Special Hazards Supplement to the CRS Coordinator's Manual*, dated 2006. This document is available through Flood Publications, NFIP/CRS, P.O. Box 501016, Indianapolis, Indiana 46250-1016. Telephone 317-845-2898.

## 4.2 Geotechnical Considerations

Soil properties during conditions of flooding are important factors in the design of any surface intended to resist flood loads. These properties include:

- saturated soil forces (see Section 4.1.1.5);
- allowable bearing capacity;
- potential for scour;
- frost zone location;
- permeability; and
- shrink-swell potential.



### CROSS REFERENCE

Specific information on landslides and other geotechnical-related natural hazards can be found at <http://landslides.usgs.gov/>.

The computation of lateral soil forces and determination of soil bearing capacity are critical in the design of foundations. These forces plus the frost zone location and potential scour play an important role in determining the type of foundation to use. Likewise, the permeability and compactibility of soils are key factors in selecting borrow materials for backfill or levee construction.

Site investigations for soils include surface and subsurface investigations. Surface investigations can identify evidence of landslides, areas affected by erosion or scour, and accessibility for equipment needed for subsurface testing and construction. Surface investigations can also help identify the suitability or unsuitability of particular foundation styles based on the past performance of existing structures. Subsurface exploration provides invaluable data on soils at and below grade. The data are both qualitative (e.g., soil classification) and quantitative (e.g., bearing capacity). Although some aspects of subsurface exploration are discussed here, subsurface exploration is too complicated and site-dependent to be covered fully in one document. Consulting with geotechnical engineers familiar with the site is strongly recommended.

If unsure of local soil conditions, obtain a copy of the U.S. Department of Agriculture, NRCS *Soil Survey* of the general area. This survey provides valuable information needed to conduct a preliminary evaluation of the soil properties, including:

- type, location, and description of soil types;
- use and management of the soil types; and
- engineering and physical properties, including plasticity indexes, permeability, shrink/swell potential, erosion factors, potential for frost action, and other information.







This information can be compiled using Figure 4-22 to enable the designer to determine the suitability of the specific soil type to support the various retrofitting methods. It is important to note that, while the soil properties may not be optimum for specific retrofitting methods, facilities can often be designed to overcome soil deficiencies.



### NOTE

The physical properties of soil are critical to the design, suitability, and overall stability of floodproofing measures. Therefore, the designer should consult a geotechnical engineer if the soil properties at a site do not support the use of the chosen retrofitting method. A geotechnical engineer should also be consulted for any information that cannot be obtained from the *Soil Survey* or the local office of the NRCS.



Geotechnical Considerations Decision Matrix								
Owner Name: _____		Prepared By: _____						
Address: _____				Date: _____				
Property Location: _____								
Considerations	Floodproofing Measures							
	 Elevation on Foundation Walls	 Elevation on Fill	Elevation on Piers	 Elevation on Posts and Columns	Elevation on Piles	 Relocation	 Dry Floodproofing	 Wet Floodproofing
<b>Lateral Soil Pressure</b>								
High								
Moderate								
Low								
<b>Bearing Capacity</b>								
High								
Moderate								
Low								
<b>Potential for Scour</b>								
High								
Moderate								
Low								
<b>Shrink/ Swell Potential</b>								
High								
Moderate								
Low								
<b>Potential Frost Action</b>								
High								
Moderate								
Low								
<b>Permeability</b>								
High								
Moderate								
Low								

Instructions: This matrix is designed to help the designer identify situations where soil conditions are unsuitable when applied to certain retrofitting measures, therefore eliminating infeasible measures. It is not intended to select the most suitable alternative. Instructions for use of this matrix follow:

1. Circle the appropriate description for each of the soil properties.
2. Use the NRCS *Soil Survey*, information from this and other reference books, and engineering judgment to determine which methods are Suitable (S) / Not Suitable (NS) for each soil property. Enter S or NS in each box.
3. Review the completed matrix and eliminate any retrofitting measures that are clearly unsuitable for the existing soil conditions.

Figure 4-22. Geotechnical Considerations Decision Matrix



The following sections begin a discussion of the various soil properties, providing the information necessary to fill out the Geotechnical Considerations Decision Matrix (Figure 4-22) and to understand the relationship between these soil properties and retrofitting measures.

### 4.2.1 Allowable Bearing Capacity

The weight of the structure, along with the weight of backfilled soil (if present), creates a vertical pressure under the footing that must be resisted by the soil. The term “allowable bearing pressure” refers to the maximum unit load that can be placed on a soil deposit without causing excessive deformation, shear failure, or consolidation of the underlying soil.

Bearing capacity has a direct effect on the design of shallow foundations. Soils with lower bearing capacities require proportionately larger foundations to effectively distribute gravity loads to the supporting soils. For deep foundations, like piles, bearing capacity has less effect on the ability of the foundation to support gravity loads because most of the resistance to gravity loads is developed by shear forces along the pile.

Bearing capacity is generally measured in pounds per square foot (lb/ft<sup>2</sup>) and occasionally in tons per square foot. Soil bearing capacity typically ranges from 1,000 lb/ft<sup>2</sup> (relatively weak soils) to more than 10,000 lb/ft<sup>2</sup> (bedrock). The allowable bearing capacity is the ultimate bearing capacity divided by an appropriate factor of safety. The factor of safety depends on whether the soils have been tested. Soil-bearing-capacity testing will result in detailed soil characteristics producing a reasonable and accurate factor of safety. An appropriate factor of safety between 2 and 3 should be used if soil testing has not been completed. See Equation 4-16.

Table 4-8 presents estimated allowable bearing capacities for various soil types to be used for preliminary sizing of footings only. The actual allowable soil bearing capacity should be determined by a soils engineer. Most local building codes specify an allowable bearing capacity to be utilized in design if the soil properties have not been specifically determined.



#### CROSS REFERENCE

An approach developed by FEMA during the elevation of substantially damaged homes in Florida and the Midwest is to reuse the existing footings, if allowed by code. Refer to FEMA 347, *Above the Flood: Elevating Your Floodprone House* (FEMA, 2000a) for details on elevation of structures.



#### EQUATION 4-16: ALLOWABLE BEARING CAPACITY

$$Q_{BC} = \frac{Q_u}{FS} \quad (\text{Eq. 4-16})$$

where:

- $Q_{BC}$  = allowable bearing capacity (lb/ft<sup>2</sup>)
- $Q_u$  = ultimate bearing capacity (lb/ft<sup>2</sup>)
- $FS$  = factor of safety (as prescribed by code)

Table 4-8. Typical Allowable Bearing Capacity by Soil Type Shown in Table 4-4

Soil Type (Symbol)	Allowable Bearing Capacity (lb/ft <sup>2</sup> )
Clay, Soft (CL, CH)	600 to 1,200
Clay, Firm (CL, CH)	1,500 to 2,500
Clay, Stiff (CL, CH)	3,000 to 4,500
Loose Sand, Wet (SP, SW, SM)	800 to 1,600
Firm Sand, Wet (SP, SW, SM, SC)	1,600 to 3,500
Gravel (GW, GP, GM, GC)	2,700 to 3,000

Once the allowable bearing capacity is determined by the soils engineer or a conservative estimate prescribed by code is made, the designer can determine the capacity of the existing foundation to support the expected loads. Depending on the outcome of that evaluation, the designer may need to supplement the existing footing to support the expected loading condition (i.e., keep the actual bearing pressure below the allowable bearing pressure of the soil) as a result of the retrofitting project.

The ability of soils to bear loads, usually expressed as shearing resistance, is a function of many complex factors, including some that are site-specific. A very significant factor affecting shearing resistance is the presence and movement of water within the soil. Under conditions of submergence, some shearing resistance may decrease due to the buoyancy effect of the interstitial water or, in the case of cohesive soils, to physical or chemical changes brought about in clay minerals.

While there are many possible site-specific effects of saturation on soil types, some classes of soil can be identified that have generally low shearing resistances under most conditions of saturation. These include:

- fine, silty sands of low density that in some localities may suddenly compact when loaded or shaken, resulting in a phenomenon known as liquefaction;
- sand or fine gravel, in which the hydraulic pressure of upward-moving water within the soil equals the weight of the soil, causing the soil to lose its shear strength and become “quicksand,” which will not support loads at the surface; and
- soils below the water table that have lower bearing capacity than the same soils above the water table.

Other types of saturated soils may also have low shearing resistances under loads, depending on numerous site-specific factors such as slope, hydraulic head, gradient stratigraphic relationships, internal structures, and density. Generally, the soils noted above should not be considered suitable for structural support or backfill for retrofitting and, when they are known to be present, a soils engineer should be consulted for site-specific solutions.

**NOTE**

Certain types of soil – loose sands and soft clays (SP, SW, SM, SC, CL, CH) exhibit very poor bearing capacities when saturated; therefore, foundation, floodwall, and levee applications in those conditions would not be feasible without special treatment.

**WARNING**

Attempts to construct water- or saturated soil-retaining/resisting structures without a thorough understanding of soil mechanics and analysis of on-site soils can result in expensive mistakes and project failure.

### 4.2.2 Scour Potential

Erosion of fill embankments, levees, or berms depends on the velocity, flow direction, and duration of exposure. Scour is localized erosion caused by the entrainment of soil or sediment around flow obstructions, often resulting from flow acceleration and changing flow patterns due to flow constriction. Where flow impinging on a structure is affected by diversion and constriction due to nearby structures or other obstructions, flow conditions estimated for the calculation of depths of scour should be evaluated by a qualified engineer.

The effects of flood loads on buildings can be exacerbated by flood-induced erosion and localized scour and by long-term erosion, all of which can lower the ground surface around foundation elements and cause the loss of load-bearing capacity and loss of resistance to lateral and uplift loads. This can render structural retrofitting and resistive designs ineffective, possibly resulting in failure. Figures 4-23 and 4-24 illustrate scour at open foundation systems and ground level buildings.

Figure 4-23. Localized scour at piers, posts, and piles

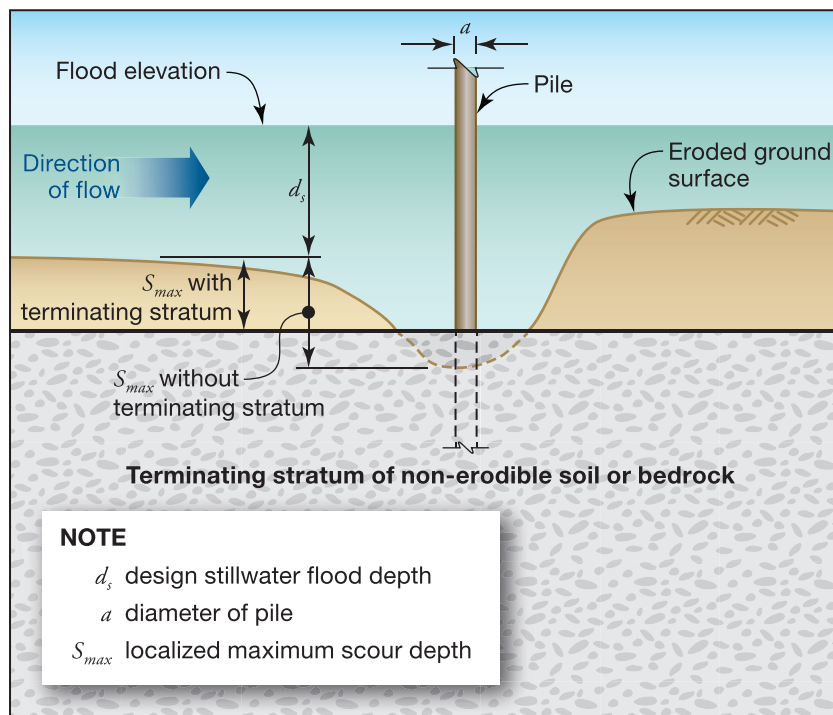

Maximum potential scour is critical in designing an elevated foundation system to ensure that failure during and after flooding does not occur due to any loss in bearing capacity or anchoring resistance around the piers, posts, or piles. If a pier, post, or pile was not designed to withstand a maximum potential scour, and was exposed to scour from a flood event, the column will be subjected to loading in a condition it was not designed for, which may result in a failure of the foundation. If a pier, post, or pile were to have 4 feet of scour around its base, and the structural element was designed to have a depth of 5 feet, the point of fixity (depth into the ground where foundation is assumed fixed against rotation) would decrease significantly, and the flood depth at the column would increase significantly.

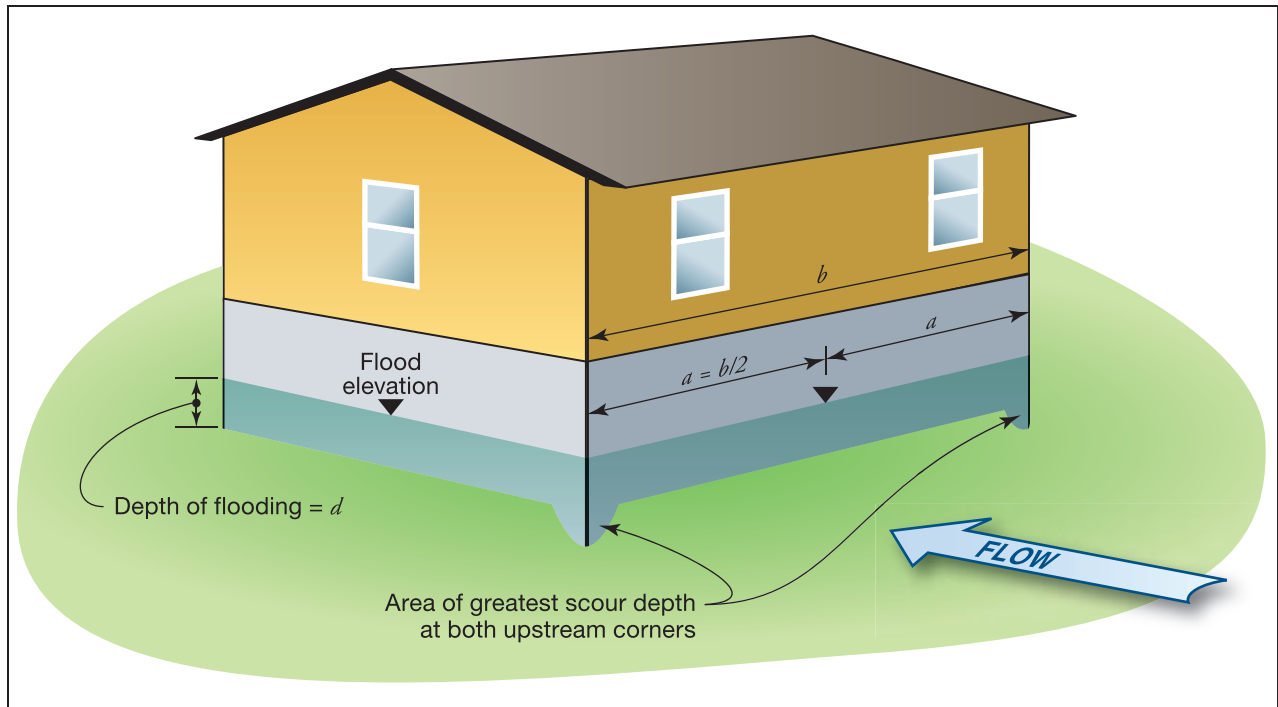

Figure 4-24. Scour action on a ground level building

The potential for foundation scour is a complex problem. Granular and other consolidated soils in which the individual particles are not cemented to one another are subject to scour, erosion, and transport by the force of moving water. The greater the velocity or turbulence of the moving water, the greater the scour potential. Soils that contain sufficient proportions of clay to be described as compact are more resistant to scour than the same grain sizes without clay as an intergranular bond. Likewise, soils with angular particle shapes tend to lock in place and resist scour forces.



#### NOTE

Resistance to scouring increases with clay content and/or the introduction of bonding agents, which help bond the internal particles of a soil together.

Shallow foundations in areas subject to flood velocity flow may be subject to scour and appropriate safeguards should be undertaken. These safeguards may include the use of different, more erosion-resistant soils, deeper foundations, surface armoring of the foundation and adjacent areas, and the use of piles or other foundations that present less of an obstruction to floodwater.

The calculation for estimating maximum potential scour depth at an elevated or ground-level foundation member (Equation 4-19) is based upon the foundation (or foundation member) shape and width, as well as the water velocity and depth, and type of soil.

Where elevation on fill is the primary retrofitting measure, embankments must be protected against erosion and scour. Scour at the embankment toe may be calculated as shown in Equation 4-17.



### EQUATION 4-17: MAXIMUM POTENTIAL SCOUR AT EMBANKMENT TOE

$$S_{max} = d \left[ 1.1 \left( \frac{a}{d} \right)^{0.4} \left( \frac{V}{(gd)^{0.5}} \right)^{0.33} \right] \quad (\text{Eq. 4-17})$$

where:

- $S_{max}$  = maximum potential depth of scour hole (ft)
- $d$  = depth of flow upstream of structure (ft)
- $a$  = diameter of pier, post, or pile or half the frontal length of the blockage (ft)
- $V$  = velocity of flow approaching the structure (ft/sec)
- $g$  = acceleration of gravity (equal to 32.2 ft/sec)

#### NOTE

The factor “ $a$ ” in Equation 4-17 is the diameter of an open foundation member or half of the width of the solid foundation perpendicular to flood flow.

The maximum potential scour depth predicted by the following equation represents a maximum depth that could be achieved if the soil material were of a nature that could be displaced by the water’s action. However, in many cases, a stronger underlying stratum will terminate the scour at a more shallow elevation. Figure 4-25 illustrates the process of determining the potential scour depth affecting a foundation system.



#### WARNING

The scour information presented is the best available; however, there is not a general consensus within the scientific community that these scour equations are valid. Research continues into this area.

**Figure 4-25. Process for estimating potential scour depth**

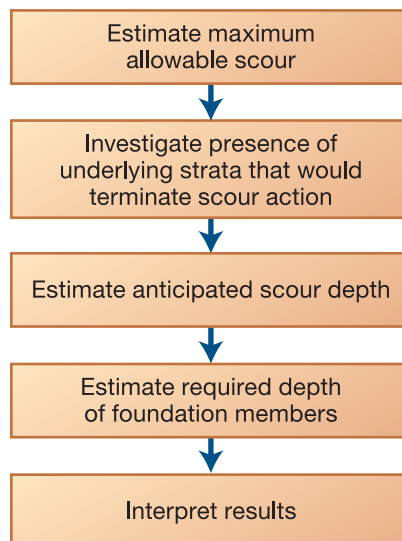

**Step 1:** Estimate maximum allowable scour. The scour depth at square and circular pier, post, and pile foundation members can be calculated as shown in Equation 4-18.



### EQUATION 4-18: LOCALIZED SCOUR AROUND VERTICAL PILE

$$S_{max} = 2.2a \quad (\text{Eq. 4-18})$$

where:

- $S_{max}$  = maximum potential depth of scour hole (ft)
- $a$  = diameter of a round foundation element, or the maximum diagonal cross section dimension for a rectangular element (ft)

#### NOTE

Equation 4-18 can also be used to approximate local scour beneath grade beams – set “ $a$ ” equal to the depth (vertical thickness) of the grade beam.

Localized scour around vertical walls and enclosed areas (e.g., typical Zone A construction) can be greater than that around vertical piles and should be calculated as shown in Equation 4-19.



#### NOTE

Scour depths estimated with Equation 4-19 can be unrealistically high for coastal areas and should be capped at 10 feet of localized scour.



### EQUATION 4-19: LOCALIZED SCOUR AROUND VERTICAL ENCLOSURE

$$S_{max} = d_s \left[ 2.2 \left( \frac{a}{d_s} \right)^{0.65} \left( \frac{V}{(gd_s)^{0.5}} \right)^{0.43} \right] K \quad (\text{Eq. 4-19})$$

where:

- $S_{max}$  = maximum potential depth of scour hole (ft)
- $d_s$  = design stillwater flood depth upstream of the structure (ft)
- $a$  = diameter of a round foundation element, or the maximum diagonal cross section dimension for a rectangular element (ft)
- $V$  = velocity of flow approaching the structure (ft/sec)
- $g$  = acceleration of gravity (equal to 32.2 ft/sec<sup>2</sup>)
- $K$  = factor applied for flow angle of attack (see Figure 4-26)



Figure 4-26.  
Flow Angle of Attack

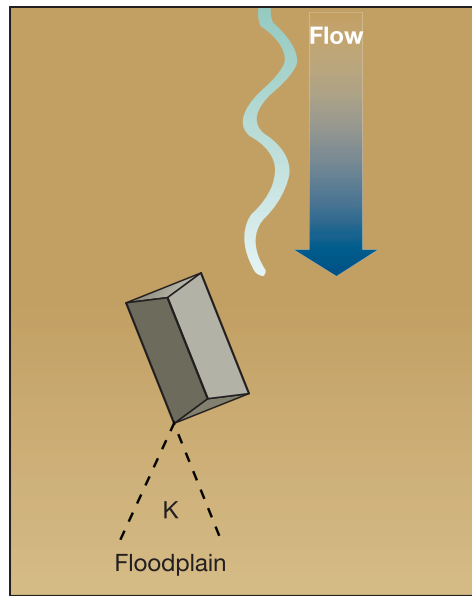

The above scour equation applies to average soil conditions (2,000–3,000 lb/ft<sup>2</sup> bearing capacity). Average soil conditions would include gravels (GW, GP, GM, and GC), sands (SW, SP, SM, and SC), and silts and clays (ML, CL, MH, and CH). For loose sand and hard clay, the maximum scour values may be increased and decreased, respectively, to reflect their lower and higher bearing capacities. However, the assistance of a soils engineer should always be sought when making this adjustment, computing scour depths, and/or designing foundations subject to scour effects.

If a wall or foundation member is oriented at an angle to the direction of flow, a multiplying factor,  $K$ , can be applied to the scour depth to account for the resulting increase in scour as presented in Table 4-9.

Table 4-9. Scour Factor for Flow Angle of Attack,  $K$

Angle of Attack	Length to Width Ratio of Structural Member in Flow			
	4	8	12	16
0	1	1	1	1
15	1.15	2	2.5	3
30	2	2.5	3.5	4.5
45	2.5	3.5	4.5	5
60	2.5	3.5	4.5	6

**Step 2:** Investigate underlying soil strata. Once the maximum potential scour depth has been established, the designer should investigate the underlying soil strata at the site to determine if the underlying soil is of sufficient strength to terminate scour activities. Information from the NRCS *Soil Survey* may be used to make this assessment (<http://websoilsurvey.nrcs.usda.gov/app/HomePage.htm>).



**NOTE**

The U.S. Department of Transportation recommends a factor of safety of 1.5 for predicting building scour depth.

Figure 4-27 illustrates a scour-terminating stratum. If an underlying terminating stratum does not exist at the site, the maximum potential scour estimate will become the anticipated scour depth. However, if an underlying terminating stratum exists, the maximum potential scour depth will be modified to reflect this condition, as shown in Step 3.

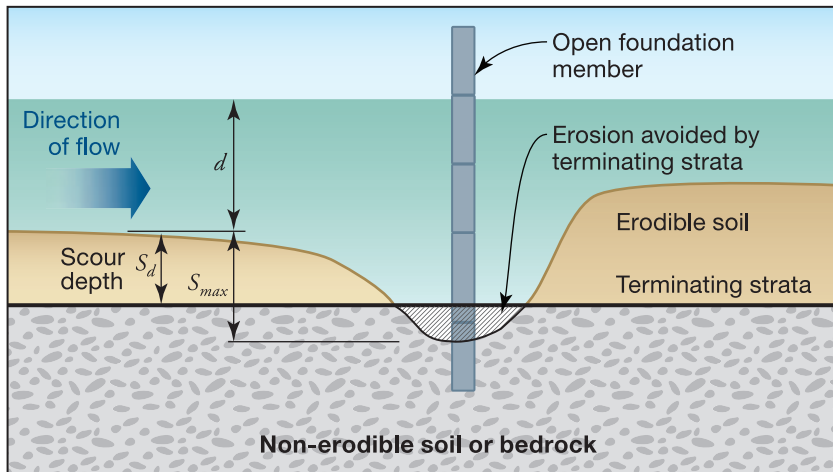

Figure 4-27. Terminating stratum

**Step 3:** Estimate anticipated scour depth. Based on the results of Step 2, the designer will determine the anticipated scour depth to be used in determining the depth to which the foundation element must be placed to resist scour effects. If a terminating stratum exists, the expected scour would stop at the depth at which this stratum starts, and the distance from this point to the surface is considered to be the potential scour depth, ( $S_d$ ). If no terminating stratum exists, the maximum potential scour ( $S_{max}$ ) computed earlier becomes the  $S_d$ .

**Step 4:** Estimate required depth of foundation members. Scour will increase the height above grade of the vertical member, since the grade level would be lowered due to erosion and scour (see Figure 4-28). As this occurs, the depth of burial ( $D_b$ ) of the vertical foundation member also decreases an identical distance. This can result in a foundation failure because the loss of supporting soils would change the assumed conditions

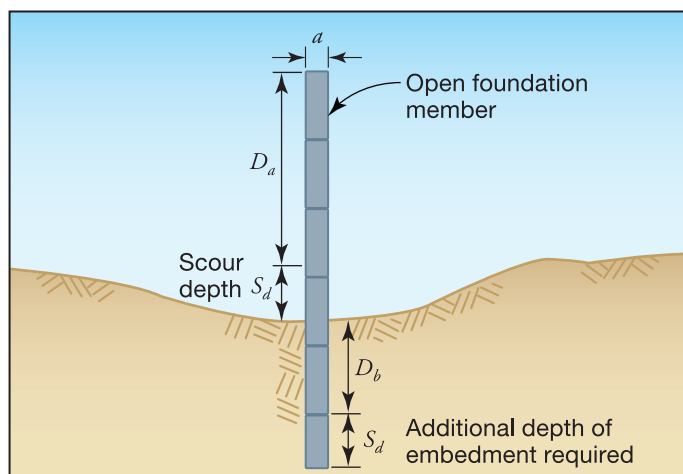

Figure 4-28. Additional embedment for foundation member

under which the elevated foundation system was designed. To account for this, the vertical foundation member depth used for the purpose of determining an acceptable design must be increased by the amount of  $S_d$ .

**Step 5:** Interpret results. Foundations, footings, and any supporting members should be protected at least to the anticipated scour depth. If the structural member cannot be buried deeper than the anticipated scour depth, the member should be protected from scour by placing rip-rap (or other erosion-resistant material) around the member, or by diverting flow around the foundation member with grading modification or construction of an independent barrier (floodwall or levee). For situations in which the anticipated scour depth is minimal, the designer should use engineering judgment to determine the required protective measures. Whenever the designer is unsure of the appropriate action, a qualified geotechnical engineer should be consulted.



### CROSS REFERENCE

Local building codes generally specify the depth of the zone of maximum frost penetration. In the absence of guidance in the local building code, refer to the NWS or the NRCS *Soil Survey*.

#### 4.2.2.1 Frost Zone Considerations

Because certain soils under specific conditions expand upon freezing, the retrofitting designer must consider the frost heave impact in the design of shallow foundations. When frost-susceptible soils are in contact with moisture and subjected to freezing temperatures, they can imbibe water and undergo very large expansions (both horizontally and vertically). Such heave or expansion exerts forces strong enough to move and/or crack adjacent structures (foundations, footings, etc.). The thawing of frozen soil usually proceeds from the top downward. The melted water cannot drain into the frozen subsoil, and thus becomes trapped, possibly weakening the soil. Normally, footing movements caused by frost action can be avoided by placing part of a foundation below the zone of maximum frost penetration.

#### 4.2.2.2 Permeability

A principal concern for the construction of retrofitting measures such as floodwalls and levees are the properties of the proposed fill material and/or underlying soils. These properties will have an impact on stability and will determine the need for seepage and other drainage control measures.

Since most retrofitting projects are constructed using locally available materials, it is possible that homogenous and impermeable materials will not be available to construct embankments and/or backfill floodwalls and foundations. Therefore, it is essential that the designer determine the physical properties of the underlying and borrowed soils.

Where compacted soils are highly permeable (i.e., sandy soils), significant seepage through an embankment and under a floodwall foundation can occur. Various soil types and their permeabilities are provided in Table 4-10.



### NOTE

While impervious cutoffs such as compacted impervious core, sheet pile metal curtains, or cementitious grout curtains can be designed to reduce or eliminate seepage, their costs are beyond the financial capabilities of most homeowners. However, several lower-cost measures to control seepage include pervious trenches, pressure relief wells, drainage blankets, and drainage toes.

Table 4-10. Typical Values of Coefficient of Permeability  $K$  for Soils

Soil Type and Description	Symbol	Typical Coefficient of Permeability (ft/day)
Well-graded clean gravels, gravel-sand mixtures	GW	75
Poorly graded clean gravels, gravel-sand-silt	GP	180
Silty gravels, poorly graded gravel-sand-silt	GM	$1.5 \times 10^{-3}$
Clayey gravels, poorly graded gravel-sand-clay	GC	$1.5 \times 10^{-4}$
Well-graded clean sands, gravelly sands	SW	4.0
Poorly graded clean sands, sand-gravel mix	SP	4.0
Silty sands, poorly graded sand-silt mix	SM	$2.0 \times 10^{-2}$
Sand-silt clay mix with slightly plastic fines	SM-SC	$3.0 \times 10^{-3}$
Clayey sands, poorly graded sand-clay mix	SC	$7.5 \times 10^{-4}$
Inorganic silts and clayey silts	ML	$1.5 \times 10^{-3}$
Mixture of inorganic silt and clay	ML-CL	$3.0 \times 10^{-4}$
Inorganic clays of low to medium plasticity	CL	$1.5 \times 10^{-4}$
Organic silt and silt-clays, low plasticity	OL	Quite Variable
Inorganic clayey silts, elastic silts	MH	$1.5 \times 10^{-4}$
Inorganic clays of high plasticity	CH	$1.5 \times 10^{-2}$
Organic clays and silty clays	OH	Quite Variable

1 cm/sec = 24,680 ft/day = 2 ft/min 1 ft/year =  $1 \times 10^{-6}$  cm/sec

The coefficient of permeability provides an estimate of ability of a specific soil to transmit seepage. It can be used (Equation 4-20) to make a rough approximation of the amount of foundation underseepage. Equation 4-20 may be used in lieu of Equation 4-14 for large levee/floodwall applications when the coefficient of permeability for the specific site soil is known.



**EQUATION 4-20: VOLUME OF SEEPAGE**

$$Q = ki_{hg}A \tag{Eq. 4-20}$$

where:

$Q$  = the discharge in a given unit of time (ft<sup>3</sup>/unit of time)

$k$  = coefficient of permeability for the soil foundation (ft/unit of time)

$i_{hg}$  = hydraulic gradient ( $h/L$ ) which is the difference in head between two points divided by the length of path between two points

$A$  = gross area of the foundation through which flow takes place (ft<sup>2</sup>)



**WARNING**

It is very important that the designer keep the units in this equation consistent. The results of Equation 4-20 depend on the homogeneity of the foundation and the accuracy of the coefficient of permeability. The results should be considered as an indication only of the order of magnitude of seepage through a foundation.

### 4.2.2.3 Shrink-Swell Potential

As mentioned earlier in this chapter, due to the continual shrink and swell of expansive soil backfills and the variation of their water content, the stability and elevation of these soils and overlaying soil layers may vary considerably. These characteristics make the use of these soils in engineering/construction applications imprudent. The NRCS *Soil Survey* for a specific area offers guidance on the shrink-swell potential of each soil group in the area as well as guidance on the suitability of their use in a variety of applications, including engineering, construction, and water retention activities. Table 4-10 provides typical values for the coefficient of permeability (K) for soils. If the designer is unsure of the type or nature of soil at the specific site, a qualified soils engineer should be contacted for assistance.

The physical soil parameters at the retrofitting and potential borrow sites are an important design consideration. Homeowners and designers should clearly understand that the advice of a professional soils engineer is vital when planning retrofitting measures that are not ideal for the physical soil parameters at a given site.

Chapter 5 provides guidance on how to apply the anticipated loads and calculate load combinations developed in this chapter to the existing site/structure. Examples for calculating flood loads, other anticipated loads, and load combinations can be found in Appendix C.



#### NOTE

Soils that exhibit severe shrinking-swell characteristics include clays and clay mixtures such as Soil Types CH, CL, ML-CL, SC, and MH.



# 5 General Design Practices

Chapter 4 introduced the analyses necessary to quantify the flood- and non-flood-related hazards that control the design of a specific retrofitting measure. The objective of this chapter is to apply the anticipated loads developed in Chapter 4 to the existing site/structure and design an appropriate retrofitting measure.

The design process begins with general practices that are basic to all retrofitting projects—field investigation and analysis of the existing structure—and then presents separate sections for each retrofit measure—elevation, relocation, dry floodproofing, wet floodproofing, and floodwalls and levees. These sections guide the designer through the process of developing construction details and specifications, and provide the tools to tailor each retrofitting measure to local requirements and homeowner preferences.

The design of these retrofitting measures is a straightforward but technically intensive approach that will result in the generation of construction plans that may receive building permits and mitigate potential flood and other natural hazards. This design process is illustrated in Figure 5-1.

As previously noted, the following section describes elements of the design process that are common to many or all retrofitting measures. The two main common design elements are field investigation (which includes surveys, documentation, and homeowner coordination) and the analysis of the existing structure.



## NOTE

FEMA strongly encourages that flood retrofits provide protection to the elevation of the DFE (or BFE plus 1 foot, whichever is higher). However, in some situations a lower flood-protection level may be appropriate. Homeowners and design professionals should meet with a local building official to discuss the selected retrofit measure and the elevation to which it will protect the home. The text and examples in this manual assume flood protection measures will be implemented to the DFE.



Figure 5-1.  
Design process

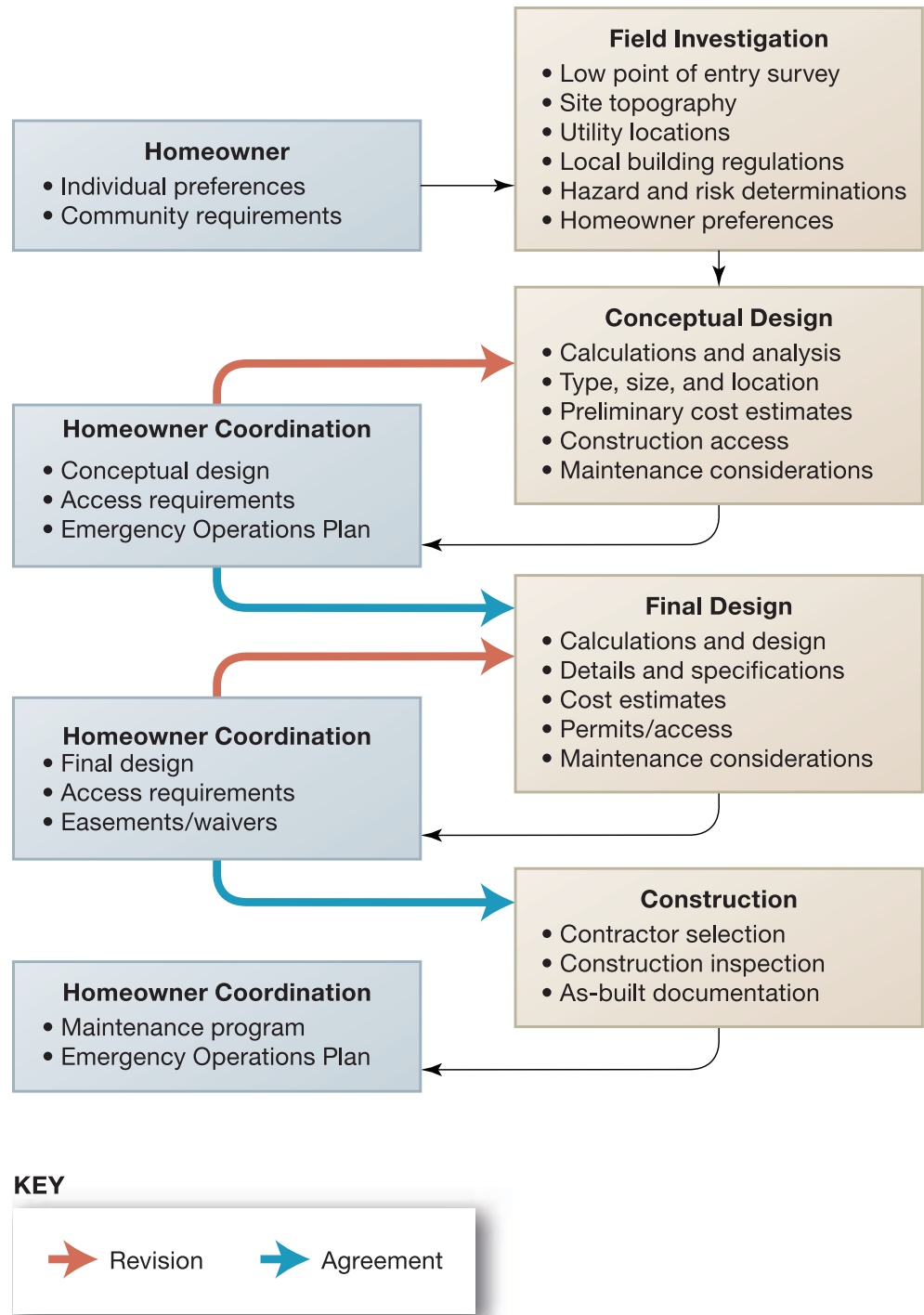

## 5.1 Field Investigation

Detailed information must be obtained about the site and existing structure to make decisions and calculations concerning the design of a retrofitting measure. The designer should obtain the following information prior to developing retrofitting measure concepts for the owner's consideration:

- Local building requirements
- Surveys
- Final hazard determinations
- Documentation of existing structural, mechanical, electrical, and plumbing systems
- Homeowner preferences

### 5.1.1 Local Building Requirements

Close coordination with the local building code official is critical to obtaining approval of a retrofitting measure design. The designer should review the selected retrofitting measure concept with the local building official to identify local design standards or practices that must be integrated into the design. This discussion may also identify, and provide an opportunity to resolve, issues where construction of the retrofitting measure may conflict with local building regulations.

### 5.1.2 Surveys

A detailed survey of the site should be completed to supplement the information gathered during the low point of entry determination (discussed in Chapter 3) and to identify and locate structure, site, and utility features that will be needed for the design of the retrofitting measure.

### 5.1.3 Structure Survey

The structure survey is a vertical elevation assessment at potential openings throughout the structure, whereby floodwater may enter the residence. It may include:

- basement slab elevation;
- windows, doors, and vents below the BFE;
- mechanical/electrical equipment and meters;
- finished floor elevation;
- drains and other floor penetrations;
- water spigots, sump pump discharges, and other wall penetrations;

- other site provisions that potentially may require flood protection, such as storage tanks and outbuildings; and
- the establishment of a stable vertical datum or elevation benchmark near the house.

### 5.1.4 Topographic Survey

A detailed retrofitting design should not be developed without a site plan or map of the area. A State-registered Professional Land Surveyor can prepare a site plan of the area, incorporating the low point of entry determination information, as well as general topographic and physical features. The entire site and/or building lot should be mapped for design purposes. General surveying practices should be observed but, as a minimum, the site plan should include:

- spot elevations within potential work areas;
- 1-foot or 2-foot contours, depending on degree of topographic relief;
- boundary markers, property lines, easements, and/or lines of division;
- perimeter of house and ancillary structures (sheds, storage tanks);
- driveways, sidewalks, patios, mailbox, fences, light poles, etc.;
- exposed utility service (meters, valves, manholes, service boxes, hydrants, etc.);
- exposed storm drain features (yard inlets, junction boxes, curb inlets);
- ditches and culverts;
- road or streets (centerline, edge or curb and gutter, curb inlets);
- downspout locations;
- trees of significant diameter (size varies per jurisdiction);
- large shrubs and other site landscaping features;
- building overhangs and chimney;
- window, door, and entrance dimensions;
- mechanical units such as A/C and heat pumps; and
- other appropriate flood data.



#### NOTE

Field surveys for design purposes should be performed by a State-registered Professional Land Surveyor.



#### WARNING

The location and elevation of all drainage features is critical.

Additionally, the site plan should extend at least 50 to 100 feet beyond the estimated construction work area. The purpose of extending the site map beyond the estimated work limits is to ensure that potential drainage and/or grading problems can be resolved. Construction site access for materials and equipment as well as sediment and erosion control measures may also have an effect on the adjacent work area. Local building code mapping issues should also be addressed.

### 5.1.5 Site Utilities Survey

As part of the field investigation, above- and below-ground site utilities should be identified. Above-ground utilities, such as power lines, manhole covers, electric meters, etc., can be located both horizontally and vertically on the topographic map. Underground utilities, such as sanitary and storm drain lines, wells and septic tanks, and electric or gas service, will require an investigation through the appropriate utility agency. Local utility companies and county, municipal, and building code officials will be able to assist in the identification of the underground utilities. In many cases, field personnel will be dispatched to mark the ground surface above buried utilities. Sometimes a copy of the topographic map and area can be submitted to the utility agency, who will prepare a sketch of their underground service. A checklist of underground services includes:

- water main and sanitary sewer pipes;
- cable television (CATV) and fiber optics;
- gas lines;
- storm drain fixtures and pipes;
- water wells;
- electric service;
- telephone cables; and
- any other local utility services.

In some instances, exact horizontal and vertical locations of the utility services may be required. A small hole, more commonly referred to as a test pit, can be dug to unearth the utility service in question. Typically this service is performed by a licensed contractor or the utility provider.

By identifying the utility services and units, provisions can be developed during the detailed design that will protect these utilities and keep them operational during a flood. Design provisions for utility relocation, encasement, elevation, anchoring, and, in some instances, new service, can be prepared.



#### NOTE

Contact local utility companies regarding the location of underground utilities before construction begins.

### 5.1.6 Hazard Determinations

The designer (with the homeowners) should review the risk determinations previously conducted in Chapter 3 and confirm the flood protection design level and required height of the retrofitting measure selected. Not merely a function of expected flood elevation, freeboard, and low point of entry, this analysis should consider the protection of all components below the design elevation (i.e., below-grade basement walls and associated appurtenances).

The analysis of flood- and non-flood-related hazards was presented in detail in Chapter 4. The designer should utilize the calculation templates presented there to finalize expected design forces.

**NOTE**

If the DFE is less than the 100-year flood elevation, the retrofitting measure may violate FEMA standards. Check with the local building official or the FEMA Regional Office for clarification.

### 5.1.7 Documentation of Existing Building Systems

Documentation of the condition of the existing structure is an important aspect of the design of elevation, relocation, and dry and wet floodproofing measures. This topic was introduced in Chapter 3 as reconnaissance designed to provide preliminary information on the condition of an existing structure and its suitability for the various retrofitting methods.

As the design of a specific elevation, relocation, or dry and wet floodproofing measure is begun, the designer should conduct a detailed evaluation of the type, size, location, and condition of the existing mechanical, electrical, and plumbing systems. The enclosed Mechanical, Electrical, Plumbing, and Related Building Systems Data Sheet (Figure 5-2) can be used to document the results of this examination.

**NOTE**

Since the data sheets provided in this book are generalized for residential housing applications and ask for information that may not be applicable to a specific retrofitting measure, the designer should exercise judgment in collecting the information cited on the checklists.

**Mechanical, Electrical, Plumbing, and Related Building Systems Data Sheet**

**(Note: Collect only the data necessary for your project)**

Owner Name: \_\_\_\_\_ Prepared By: \_\_\_\_\_

Address: \_\_\_\_\_ Date: \_\_\_\_\_

Property Location: \_\_\_\_\_

**A. Exterior Utilities and Appurtenances**

**Water**

- On-site well or spring                       Public water system

Water purveyor's name: \_\_\_\_\_

**Sanitary**

- On-site septic and drain field                       Public sewerage

**Storm**

- On-site     Public sewerage

**Incoming Electrical Service**

- Overhead                       Underground                       Voltage                       120/240 volt 10                       120/208 volt 10

Direct burial size: \_\_\_\_\_

Service entrance cable amps: \_\_\_\_\_

- PVC (Polyvinylchloride) conduit                       RGS (Rigid Galvanized Steel) conduit

Transformer #:

Power company:

Power meter #:

Contact: \_\_\_\_\_

Estimated transformer rating: \_\_\_\_\_

Fault current rating: \_\_\_\_\_

Telephone service: \_\_\_\_\_

- Company:                       Overhead                       Underground                       Cable pair                       Pedestal                       Grounded                       Direct burial

**CATV**

Company: \_\_\_\_\_

- Overhead                       Underground # of channels: \_\_\_\_\_                       PVC CATV #:

- Direct Burial                       RGS

Contact: \_\_\_\_\_

**Figure 5-2. Mechanical, Electrical, Plumbing, and Related Building Systems Data Sheet**



**Other Utilities**

Natural gas  
 Utility company name: \_\_\_\_\_  
 Location of service entrance: \_\_\_\_\_  
 Meter location: \_\_\_\_\_

LPG (Liquefied Petroleum Gas)  
 Utility company name: \_\_\_\_\_  
 Location of gas bottle: \_\_\_\_\_

How is tank secured?     Oil  
 Oil Supplier: \_\_\_\_\_

Aboveground tank     Underground tank  
 Size (in gallons [GAL]): \_\_\_\_\_ Location: \_\_\_\_\_  
 Vent terminal: \_\_\_\_\_  
 Elevation: feet or elevation above grade? \_\_\_\_\_ feet    Fill cap type: \_\_\_\_\_

**B. Domestic Plumbing**

**Water**

Location of service entrance  
 Main service valve?     Yes     No  
 Backflow preventer?     Yes     No  
 Type of water pipe     Copper     Iron     Plastic  
 Domestic water heater     Gas BTU/HR     Oil GAL/HR     Other Specify units  
 Size (GAL): \_\_\_\_\_ Location: \_\_\_\_\_

**Sanitary Drainage**  
 Floor served? \_\_\_\_\_  
 Fixtures below base flood elevation(BFE)     Yes     No  
 Backwater valve installed in fixtures below BFE?     Yes     No  
 Backwater valves needed (if none exist)     Yes     No

**Storm Drainage**  
 Basement floor drains connected?     Yes     No  
 Is storm combined w/sanitary?     Yes     No

**C. Heating System**

Type:     Central System     Space heaters

**Central System**  
 Warm air     Hot water     Steam

**Warm Air Furnace**  
 Location:     Basement     1st floor     \_\_\_ floor     Attic

Page 2 of 3

Figure 5-2. Mechanical, Electrical, Plumbing, and Related Building Systems Data Sheet (continued)

Type:	<input type="checkbox"/> Upflow	<input type="checkbox"/> Downflow	<input type="checkbox"/> Horizontal	<input type="checkbox"/> Low Boy	
Fuel:	<input type="checkbox"/> Natural Gas	<input type="checkbox"/> LPG	<input type="checkbox"/> Electric	<input type="checkbox"/> Coal	<input type="checkbox"/> Wood
Burner:	<input type="checkbox"/> Atmospheric	<input type="checkbox"/> Fan assisted			
Condensing:	<input type="checkbox"/> Yes	<input type="checkbox"/> No			
Venting:	<input type="checkbox"/> Natural draft	<input type="checkbox"/> Forced draft	<input type="checkbox"/> Direct vent		
Air Distribution:	<input type="checkbox"/> Gravity	<input type="checkbox"/> Ducted			
	<input type="checkbox"/> Sheet metal ductwork	<input type="checkbox"/> Flexible, non-metallic runouts	<input type="checkbox"/> Fiberglass ductboard	<input type="checkbox"/> Location	
Air Outlets:	<input type="checkbox"/> Floor	<input type="checkbox"/> Low sidewall	<input type="checkbox"/> High sidewall	<input type="checkbox"/> Ceiling	<input type="checkbox"/> 2nd floor
<b>Hot Water/Steam:</b>					
Boiler:	<input type="checkbox"/> Hot Water	<input type="checkbox"/> Steam			
Location:	<input type="checkbox"/> Basement	<input type="checkbox"/> 1st Floor	<input type="checkbox"/> ___ floor	<input type="checkbox"/> Attic	
Fuel:	<input type="checkbox"/> Natural Gas	<input type="checkbox"/> LPG	<input type="checkbox"/> Electric	<input type="checkbox"/> Coal	<input type="checkbox"/> Wood
Terminal Units:	<input type="checkbox"/> Baseboard	<input type="checkbox"/> Radiators	<input type="checkbox"/> Other		
<b>In-Space Heating Equipment</b>					
Gas:	<input type="checkbox"/> Room heater	<input type="checkbox"/> Vented	<input type="checkbox"/> Unvented		
	<input type="checkbox"/> Wall furnace	<input type="checkbox"/> Conventional	<input type="checkbox"/> Direct vent		
	<input type="checkbox"/> Floor furnace				
Oil/Kerosene:	<input type="checkbox"/> Vaporizing oil pot heater	<input type="checkbox"/> Powered atomizing heater	<input type="checkbox"/> Portable kerosene heater		
Electric Heaters:	<input type="checkbox"/> Wall	<input type="checkbox"/> Floor	<input type="checkbox"/> Toe space	<input type="checkbox"/> Baseboard	
Radiant Heat:	<input type="checkbox"/> Panels	<input type="checkbox"/> Embedded fireplace		<input type="checkbox"/> Portable cord and plug	
Stoves:	<input type="checkbox"/> Conventional	<input type="checkbox"/> Advanced design	<input type="checkbox"/> Fireplace insert	<input type="checkbox"/> Pellet stove	
<b>D. Cooling System</b>					
Type:	<input type="checkbox"/> Central	<input type="checkbox"/> In-space air conditioners (ACs)			
Central Systems:	<input type="checkbox"/> Split system A/C	<input type="checkbox"/> Unitary A/C	<input type="checkbox"/> A-Coil add-on		
	<input type="checkbox"/> Split system heat pump				
<b>Split Systems:</b>					
Indoor unit location:	<input type="checkbox"/> Basement	<input type="checkbox"/> 1st Floor	<input type="checkbox"/> ___ Floor	<input type="checkbox"/> Attic	
Type:	<input type="checkbox"/> Upflow	<input type="checkbox"/> Downflow	<input type="checkbox"/> Horizontal		
Air distribution:	<input type="checkbox"/> Sheet metal ductwork	<input type="checkbox"/> Fiberglass ductboard	<input type="checkbox"/> Flexible non-metallic runouts		
Air outlets:	<input type="checkbox"/> Floor	<input type="checkbox"/> Low sidewall	<input type="checkbox"/> High sidewall	<input type="checkbox"/> Ceiling	
Outdoor unit location:					
In-space air conditioners:	<input type="checkbox"/> Window air conditioners		<input type="checkbox"/> Ductless split systems		
Page 3 of 3					

Figure 5-2. Mechanical, Electrical, Plumbing, and Related Building Systems Data Sheet (concluded)

### 5.1.8 Homeowner Preferences

A detailed discussion of homeowner preferences was presented in Chapter 3. The designer should confirm the homeowner's preferences regarding:

- retrofitting measure type, size, and location(s);
- project design desires/preferences;
- limitations on construction area;
- estimated construction budget; and
- potential future site improvements.

Once the designer has collected the above-mentioned information, a conceptual design of the proposed retrofitting measure can be discussed with the homeowner.

At this time, the designer should also review and confirm coordination and future maintenance requirements with the homeowner to ensure that the selected retrofitting measure is indeed suitable.

### 5.1.9 Homeowner Coordination

Homeowner coordination is similar for each of the retrofitting methods and involves reviewing design options, costs, specific local requirements, access and easement requirements, maintenance requirements, construction documents, and other information with the homeowner and regulatory officials to present the alternatives, resolve critical issues, and obtain necessary approvals.

### 5.1.10 Maintenance Programs and Emergency Action Plans

Development of appropriate maintenance programs for retrofitting measures is critical to the continued success of retrofitting efforts. Refer to FEMA's NFIP Technical Bulletin 3-93, *Non-Residential Floodproofing – Requirements and Certification for Buildings Located in Special Flood Hazard Areas in Accordance with the NFIP* (FEMA, 1993) for additional guidance concerning minimum recommendations for Emergency Operations Plans and Inspection and Maintenance Plans. While this bulletin was prepared for non-residential structures, it contains sound advice for the development of emergency operations, inspection, and maintenance plans.

Design information presented in this chapter relates to field investigation, design calculations and construction details, and construction issues. Since many of the key elements in the field investigation phase were discussed above, only those issues that are critical to the design and successful construction of the particular retrofitting measure are included here.

## 5.2 Analysis of Existing Structure

The ability of an existing structure to withstand the additional loads created as a result of retrofitting is an important design consideration. Accurate estimates of the capacity of the foundation and other structural systems are the first steps in the design of retrofitting measures. The objective of this analysis is to identify the extent to which structural systems must be modified or redesigned to accommodate a retrofitting measure such as elevation, relocation, dry and wet floodproofing, and floodwalls or levees. The steps involved in this analysis include:

- structural reconnaissance;
- determination of the capacity of the existing footing and foundation system; analysis of the loads imposed by the retrofitting measure; and
- comparison of the capacity of the existing structure to resist the additional loads imposed by the retrofitting measure.

### 5.2.1 Structural Reconnaissance

In order to determine whether a structure is suited to the various retrofitting measures being considered, the type and condition of the existing structure must be surveyed. Some structural systems are more adaptable to modifications than others. Some retrofitting methods are more suited for, or specifically designed for, various construction types. Of the retrofitting methods discussed, elevation, relocation, and dry floodproofing most directly affect a home's structure. Floodwalls and levees are designed to prevent water from reaching the home's and thus should not have an impact on the structure. Wet floodproofing techniques have a lesser impact on the structure due to equalization of pressures, and also require analysis of the existing structure.

Several sources of information concerning the details of construction that were used in a structure include:

- construction drawings from the architect, engineer, or builder. These are usually the best and most reliable resource for determining the structural systems and the size of the members. The retrofit designer of record should verify by inspection wherever possible that materials were installed as specified on the referenced drawings;
- information available from the building permits office;
- plans of any renovations or room additions and a recent record of existing conditions;
- contractors who have performed recent work on the home, such as plumbing, mechanical, electrical, etc.; and
- a home inspection report, if the home has been recently purchased. While these reports are not highly detailed, they may give a good review of the condition of the home and point out major deficiencies.

If the aforementioned information is not available, the designer (with the permission of the owner) should determine the type and size of the critical structural elements. The Structural Reconnaissance Worksheet provided as Figure 5-3 can be used to document this information.

Owner Name: _____ Address: _____ Property Location: _____	Prepared By: _____ Date: _____			
<b>Structural Reconnaissance Worksheet</b>				
Sketch and Description of Existing Structure  <div style="border: 1px solid black; height: 80px; width: 100%;"></div>				
Item	Material	Size	Condition (Excellent, Good, Fair, Unacceptable)	Notes
Flooring	Concrete			
Foundation Wall	Concrete			
	Concrete Masonry			
	Brick Masonry			
Walls	Wood Frame			
	Masonry			
	Metal Frame			
Floor System	Wood Joist			
	Post and Beam			
	Wood Truss			
Roof System	Truss			
	Rafter			
Exterior Finishes	Wood Siding			
	Brick Veneer			
	Stucco			
Interior Finishes	Drywall			
	Plaster			
	Wood			

Figure 5-3. Structural Reconnaissance Worksheet

### 5.2.2 Footings and Foundation Systems

The foundation system of a house (footings and foundation walls) serves several purposes. It supports the house by transmitting the building loads to the ground, and it serves as an anchor against uplift and against forces caused by wind, seismic, flooding, and other loads. Foundation walls (below grade) restrain horizontal pressures from adjacent soil pressures. The foundation system anchors the house against horizontal, vertical, and shear loads



**NOTE**

Elevating a house exposes it to greater vertical loads from increased wind loads and additional weight, and horizontal and shear loads from increased wind forces. Figure 5-4 illustrates the various loads that affect a foundation system.

from water, soil, debris, seismic, snow, and wind hazards. Retrofitting measures such as elevation change the dynamics of the forces acting on a house. More details regarding foundations and the loads experienced by them can be found in the Fourth Edition of FEMA P-55, *Coastal Construction Manual* (FEMA, 2011) in Chapters 8 through 10. FEMA P-550, *Recommended Residential Construction for Coastal Areas* (FEMA, 2009) also provides design plans for coastal foundations and guidance for design and construction.

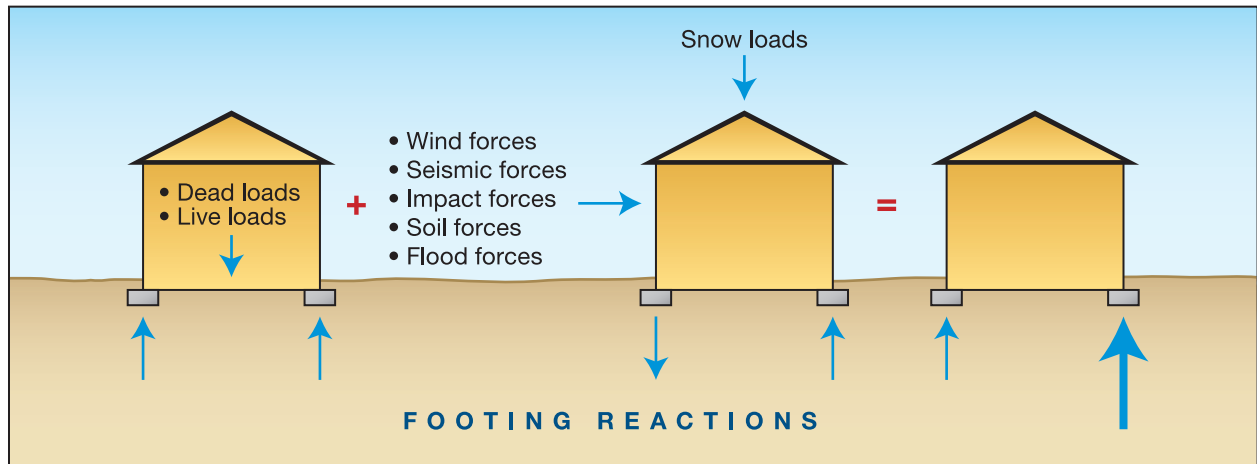

Figure 5-4. Foundation system loading

### 5.2.3 Bearing Capacity of Footings

Footings are designed to transmit building loads to the ground and should be placed completely below the maximum frost penetration depth. The size of the footing can be determined by Equation 5-1.

In conducting this computation, it is important to confirm the size and depth of the footing and bearing capacity of the soil to ensure that the existing conditions meet current codes. In the absence of reliable information, excavation may be required to confirm the depth, size, and condition of the existing footing.

The designer should also check the existing footing to ensure that it has a perimeter drainage system to prevent saturation of the soil at the footing. If one does not exist, the designer should consider including this feature in the design of the retrofit.



#### NOTE

The load carrying capacities of residential footings, particularly strip footings, are usually limited by the bearing capacity of the soil. For spread footings (i.e., isolated footings that may be spread over a relatively large area), the footing may be controlled by the structural capacity of the footing itself. Thus, spread footings typically require reinforcing bars near the bottom of the footing. In general, when  $x$  exceeds 1.5 times  $t_f$  in the figure below, an analysis of shear and bending forces is required. Refer to ACI 318-08, *Building Code Requirements for Structural Concrete and Commentary* (2008), for investigations of such concrete footings.

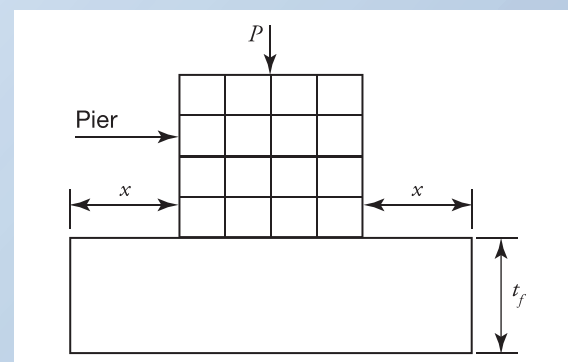





### EQUATION 5-1: DETERMINING FOOTING SIZE

$$A_f = \frac{P}{S_{bc}} \quad (\text{Eq. 5-1})$$

where:

$A_f$  = bearing area of the footing (ft<sup>2</sup>)

$P$  = load (lb)

$S_{bc}$  = allowable soil bearing capacity (lb/ft<sup>2</sup>);  
see Table 5-2



### NOTE

Perimeter drainage systems may be used if the bearing soil is adversely affected by saturation. Often soils under bearing pressure will not become saturated due to low permeability. Each situation should be evaluated separately.



### EQUATION 5-2: MAXIMUM LOADING OF EXISTING FOOTING

$$P_{max} = A_f S_{bc} \quad (\text{Eq. 5-2})$$

where:

$A_f$  = bearing area of the footing (ft<sup>2</sup>)

$P_{max}$  = max load (lb)

$S_{bc}$  = allowable soil bearing capacity (lb/ft<sup>2</sup>);  
see Table 5-2



### CROSS REFERENCE

*American Concrete Institute 530, 2008, (ACI 530-08)* provides maximum height or length to thickness ratios. Height or length is based on the location of the lateral support elements that brace the masonry and permit the transfer of loads to the resisting elements. Nominal wall thickness may be used for  $t_{wall}$ . Table 5-2. "Wall Lateral Support Requirements" (ACI 530-08) provides maximum slenderness ratio values for bearing and non-bearing walls.



### EQUATION 5-3: BEARING CAPACITY OF EXISTING STRIP FOOTING

$$W_f = b_f S_{bc} \quad (\text{Eq. 5-3})$$

where:

$W_f$  = total weight footing wall support (lb/ft)

$b_f$  = width of footing (ft)

$S_{bc}$  = allowable soil bearing capacity (lb/ft<sup>2</sup>);  
see Table 5-2



### NOTE

$W_f$  acts downward.



### CROSS REFERENCE

Use of Equation 5-4 is limited and should be verified using ACI 530-08 and local building codes for design applications.

## 5.2.4 Bearing Capacity of Foundation Walls

The bearing capacity of an existing concrete masonry foundation wall can be estimated if the designer knows the size and grade of the block, using the following equation.



### EQUATION 5-4: BEARING CAPACITY OF EXISTING STRIP FOOTING

$$W_w = S_c A \quad (\text{Eq. 5-4})$$

where:

$W_w$  = total weight per linear foot (lf) wall will support (lb/ft)

$S_c$  = bearing capacity of the masonry from Table 5-1 (lb/in.<sup>2</sup>)

$A$  = cross-sectional area per lf of wall =  $t_w$  (12 in.)

where:  $t_w$  thickness of wall in inches

By changing the value of the bearing capacity according to the conditions identified on the site, the designer can determine the approximate weight that the foundation wall will support. If the type of block and mortar is unknown, the most conservative values should be used. Intrusive methods of investigation must be employed to determine footing depth, thickness, reinforcement, condition, or drainage. Technology exists for investigation of walls using x-ray, ultrasound, and other methods; however, these methods may be too costly for residential retrofitting projects.



#### NOTE

The approximate bearing capacity of concrete and reinforced concrete materials may be quite variable due to regional differences in concrete mix, aggregate, reinforcing practices, and other factors. In general, the approximate bearing capacity of concrete/reinforced concrete is substantially greater than masonry block: a conservative estimate ranges from 500 to 1,000 pounds per square inch. Additional information on the capacity and strength of concrete mixtures can be obtained from ACI 318-08.

## 5.2.5 Lateral Loads

The ability of exterior foundation walls and interior structural walls to withstand flood-related and non-flood-related forces is dependent upon the wall size, type, and material. Interior and exterior walls are checked for failure from overturning, bending, and shear (horizontal, vertical, and diagonal). If the stress caused by the expected loading is less than the code-allowable stress for the expected failure mode, the wall design is acceptable. Conversely, if the stresses caused by the expected loadings are greater than the code-allowable stresses for the expected failure mode, the design is unacceptable and reinforcing is required.

Table 5-1. Approximate Bearing Capacity for Masonry Wall Types

Masonry Units	Approximate Compressive Bearing Capacity for Masonry Walls, $S_{bc}$ , Based on Gross Cross-Section (lb/in <sup>2</sup> )*
Solid masonry of brick and other solid units of clay or shale; sand-lime or concrete brick **	100 to 115
Grouted masonry of clay or shale; sand-lime or concrete**	100 to 115
Hollow units of concrete masonry	55 to 75
<b>Stone</b>	
Cut granite	640 to 720
Cut limestone, marble	400 to 450
Cut sandstone, cast stone	320 to 360
Rubble; rough, random, or coursed	100 to 120

SOURCE: DERIVED FROM ACI 530-08 TABLE 5.4.2

\* Minimum thickness: Masonry bearing walls – one story, 6 inches; more than one story, 8 inches

\*\* Compressive strength of masonry unit, gross area, equal to 1,500 psi

Note: See ACI 530-08 if dimensions stated above are not met.

Table 5-2. Presumptive Vertical Load-Bearing Capacities for Different Materials

Material Class	$S_{bc}$ , lb/ft <sup>2</sup> *
1. Rock	4,000+
2. Sandy gravel, gravel	3,000
3. Sand, silty sand, clayey sand, silty gravel, clayey gravel	2,000
4. Clay, sandy clay, silty clay, clayey silt	1,500

SOURCE: DERIVED FROM 2012 IBC TABLE 1806.2

\* Minimum thickness: Masonry bearing walls – one story, 6 inches; more than one story, 8 inches

\*\* Compressive strength of masonry unit, gross area, equal to 1,500 psi

Note: See ACI 530-08 if dimensions stated above are not met.



**NOTE**

Values shown in Table 5-1 are guidelines. Additional information on the capacity and strength of masonry construction can be obtained from ACI 530-08.



**NOTE**

For masonry walls, use ACI 530-08 to determine allowable stress information. For plywood shear walls, the Engineered Wood Association offers allowable load information. For reinforced concrete walls, consult ACI 318-08. For non-reinforced concrete walls, consult Chapter 22 of ACI 318-08.



**NOTE**

Values shown in Table 5-2 are guidelines.

Due to the large number of wall types and situations that can be encountered that would make a comprehensive examination of this subject unwieldy for this manual, only procedural and reference information for lateral load resistance is provided. The process of analyzing foundation and interior walls is outlined below:

**Step 1:** Determine the type, size, material, and location of the walls to be analyzed.

**Step 2:** Determine the code-allowable overturning, bending, and shear stresses for the wall in question.

**Step 3:** Compare the stresses caused by the expected loadings versus code-allowable stresses (capacities) for each wall being analyzed. If the stresses caused by the expected loadings are less than the code-allowable stresses, the design is acceptable; if not, reinforcement is required or another method should be considered.

### 5.2.6 Vertical Loads

In addition to the loads imposed by floodwater, other types of loads must be considered in the design of a structural system, such as building dead loads, live loads, snow loads, wind loads, and seismic loads (if applicable). Flood, wind, and seismic loads were discussed earlier in Chapters 3 and 4. This section deals with the computation of dead loads, live loads, and roof snow loads.

### 5.2.7 Dead Loads

Dead loads are the weight of all permanent structural and nonstructural components of a building, such as walls, floors, roofs, ceilings, stairways, and fixed service equipment. The sum of the dead loads should equal the unoccupied weight of the building. The weight of a house can be determined by quantifying the wall and surface areas and multiplying by the weights of the materials or assemblies. A list of the weights of some construction components and assemblies is provided in Table 5-3. In addition to the weight of the structure, any permanent service equipment located in the house must be added to the total. The worksheet provided at Figure 5-5 can be used to make a preliminary estimate of the weight of a structure. To use Figure 5-5, the designer should:

**Step 1:** Determine the construction of the various components of the building, quantify them, and enter this information in the second column.

**Step 2:** Look up the weight of these assemblies and enter that figure into the third column.



#### NOTE

Lateral loads are distributed to the shear walls via the diaphragms of the floor or roof. Distribution is based upon relative stiffnesses of the walls. Use extreme care in the design of diaphragm-to-wall connections. Most codes require that an additional eccentricity (factor of safety) be considered in the location of the resultant lateral loads.



#### CROSS REFERENCE

For additional information on loading conditions for exterior and shear walls, refer to ASCE 7.



#### NOTE

Values provided in Table 5-3 are typical guideline values. See ASCE 7 for additional information.

**Table 5-3. Weights of Construction Types**

Construction	Weight, lb/ft <sup>2</sup> surface area
Wood stud wall, 2x4, interior, ½-in. drywall 2S	8
Interior, wood or metal 2x4s, plaster 2S	19
Exterior, drywall; 4-in. batt insulation; wood siding	11
Exterior, drywall; 4-in. batt insulation; 4-in. brick (MW)	47
Exterior, drywall; 4-in. batt insulation; 8-in. concrete block	60-65
Metal stud wall, 2x4, interior, ½-in. drywall 2S	7
Exterior, drywall; 4-in. batt insulation; 1-in. stucco	23
Metal stud wall, exterior, drywall; 4-in. batt insulation; 2-in. drywall	18
Exterior, drywall; 4-in. batt insulation; 3-in. granite or 4-in. brick	55
Plaster, per face, wall, or ceiling, on masonry or framing	8
Ceramic tile veneer, per face	10
MW, 4-in. brick, MW, per wythe (continuous vertical section of masonry, one unit in thickness)	39
4-in. conc. block, heavy aggregate, per wythe	30
8-in. conc. block, heavy aggregate, per wythe	55
Glass block wall, 4-in. thick	18
Glass curtain wall	10-15
Floor or ceiling, 2x10 wood deck, outdoors	8-10
Wood frame, 2x10, interior, unfinished floor; drywall ceiling	8-10
Concrete flat slab, unfinished floor; suspended ceiling	80-90
Concrete pan joist (25 in. o.c., 12-in. pan depth, 3-in. slab), unfinished floor; suspended ceiling	90-100
Concrete on metal deck on steel frame, unfinished floor; suspended ceiling	65-70
Finished floors, add to above:	
Hardwood	3
Floor tile 1½-in. terrazzo	10
Wall-to-wall carpet	25
<b>Roofing, add to above:</b>	
Roof, sloping rafters or timbers, sheathing; 10-in. batt insulation; ½-in. drywall	12-15
Built-up 5-ply roofing, add to above	6
Metal roofing, add to above	3-4
Asphalt shingle roofing, add to above	4
Slate or tile roofing, ¼-in. thick, add to above	12
Wood shingle roofing, add to above	3-5
<b>Insulation, add to above:</b>	
Insulation, batt, per 4-in. thickness	1
Insulation, rigid foam boards or fill, per inch thickness	0.17
<b>Stairways:</b>	
Concrete	80-95
Steel	40-50
Wood	15-25

2S = 2 sides MW = Masonry walls o.c. = on centers

Building Weight Estimating Worksheet			
Owner Name: _____		Prepared By: _____	
Address: _____		Date: _____	
Property Location: _____			
Construction Type (1)	Surface Area (2)	Weight (lb/ft <sup>2</sup> ) of Surface Area (3)	Weight Component(4)
Walls Exterior			
Interior			
First Floor			
Second Floor			
Attic			
Roof Special Items			
Fireplace*			
Chimney*			
<b>Structure Weight</b>			
<b>Total Weight</b>			

\*Do not include if chimney/fireplace has a separate foundation

Figure 5-5. Building Weight Estimating Worksheet

**Step 3:** Multiply the quantities by the unit weights to obtain the construction component weights, and enter the result in the fourth column.

**Step 4:** Add these component weights in column four to obtain an estimate of the total weight of the structure. Enter the result in the box at the bottom of column four.

### 5.2.8 Live Loads

Live loads are produced by the occupancy of the building, not including environmental loads such as wind loads, flood loads, snow loads, earthquake loads, or dead loads. For residential one- and two-family dwellings, a typical floor live load is a uniformly distributed load of 40 pounds per square foot.



#### CROSS REFERENCE

Check local codes for guidance on acceptable live loads. In the absence of code information use ASCE 7.





### EQUATION 5-5: CALCULATION OF LIVE LOADS

$$LL = AL_o \quad (\text{Eq. 5-5})$$

where:

$LL$  = live load (lb)

$A$  = area of each floor of the residence (ft<sup>2</sup>)

$L_o$  = minimum uniformly distributed live load (lb/ft<sup>2</sup>)

### 5.2.9 Roof Snow Loads

The roof snow load varies according to the geography, roof slope, and thermal, exposure, and importance factors. Local building codes should be consulted to find the snow load and how to apply it to the structure. Take particular care to account for drift and unbalanced snow loads. If no local code is available, the designer should refer to ASCE 7 for this information. In areas of little snowfall, codes may require a minimum roof snow load.

### 5.2.10 Calculation of Vertical, Dead, Live, and Snow Loads

Dead, live, and snow loads act vertically downward and are carried by the load-bearing walls or the columns to the foundation system. The load-bearing walls support any vertical load in addition to their own weight. The amount of the dead load carried by a wall or column is calculated based on the partial area of the roof and floor system (tributary areas) that are supported by that wall or column plus its own weight (self weight). The tributary areas are illustrated in Figures 5-6 and 5-7 and determined using Equation 5-6, Equation 5-7, or Equation 5-8.

For the load-bearing walls, the tributary area is the area bounded by the length of the wall perpendicular to the floor joists or roof trusses multiplied by half the span length of the joist or truss.



### EQUATION 5-6: CALCULATION OF TRIBUTARY AREA FOR LOAD-BEARING WALLS

$$A_w = \frac{lw}{2} \quad (\text{Eq. 5-6})$$

where:

$A_w$  = wall tributary area (ft<sup>2</sup>)

$l$  = length of the wall (ft)

$w$  = span length between walls or the wall and center girder (ft)



### EQUATION 5-7: CALCULATION OF TRIBUTARY AREA FOR CENTER GIRDER

$$A_g = \frac{l(a+b)}{2} \quad (\text{Eq. 5-7})$$

where:

- $A_g$  = center girder tributary area (ft<sup>2</sup>)
- $l$  = length of the girder (ft)
- $(a+b)$  = length between adjacent parallel supports – wall or girder – per Figure 5-7 (ft)

For columns, the tributary area is the area bounded by imaginary lines drawn halfway between the column and the adjacent load-bearing wall or column in each direction.



### EQUATION 5-8: CALCULATION OF TRIBUTARY AREA FOR COLUMNS

$$A_t = \frac{(wl)}{4} \quad (\text{Eq. 5-8})$$

where:

- $A_t$  = column tributary area (ft<sup>2</sup>)
- $l$  = length of the wall surrounding the column (ft)
- $w$  = span length between walls surrounding the column (ft)

To calculate the loads, follow the steps below:

**Step 1:** Inspect the roof and the floor construction to identify load-bearing walls. Mark the direction, the span length, and the supporting walls or columns for the roof trusses and floor joists.

**Step 2:** Calculate the roof and the floor tributary areas for each load-bearing wall and column.

**Step 3:** For each load-bearing wall and column, multiply the tributary areas by the dead, live, and snow loads to find the total loads.

Figure 5-6.  
Column  
tributary area

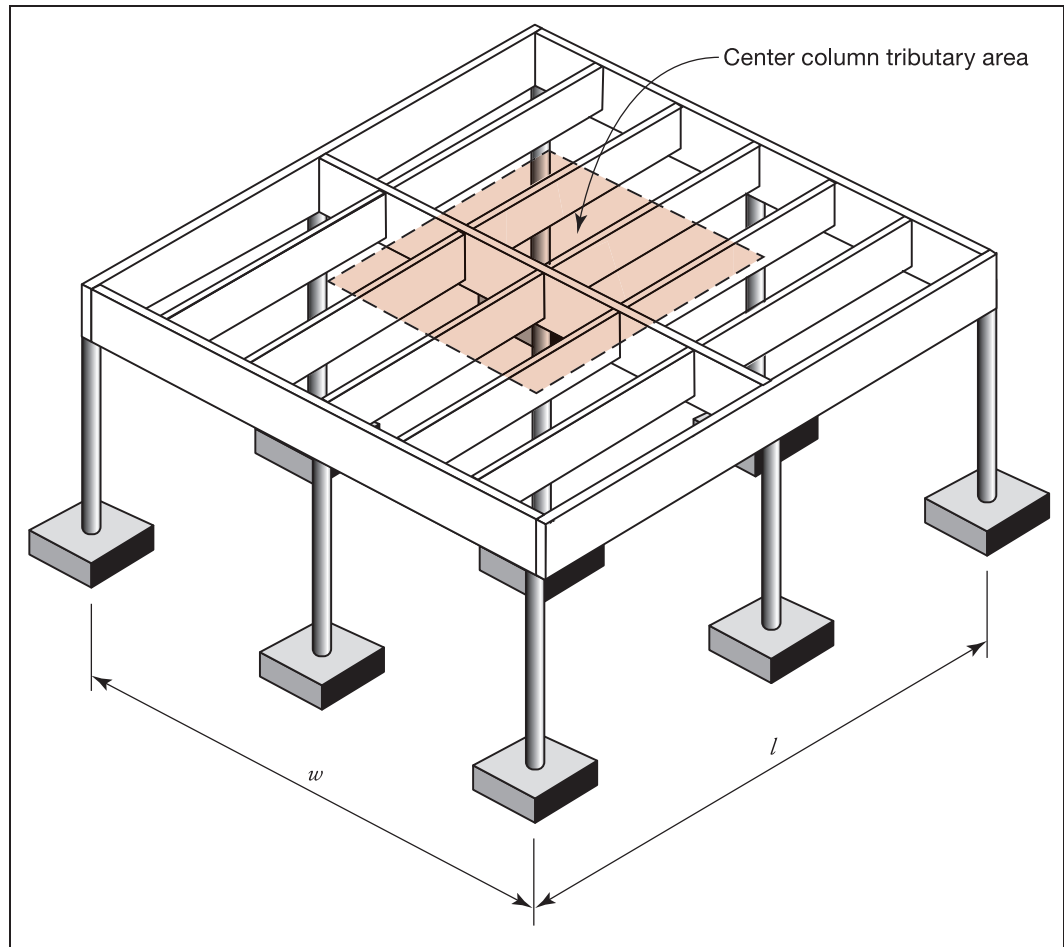
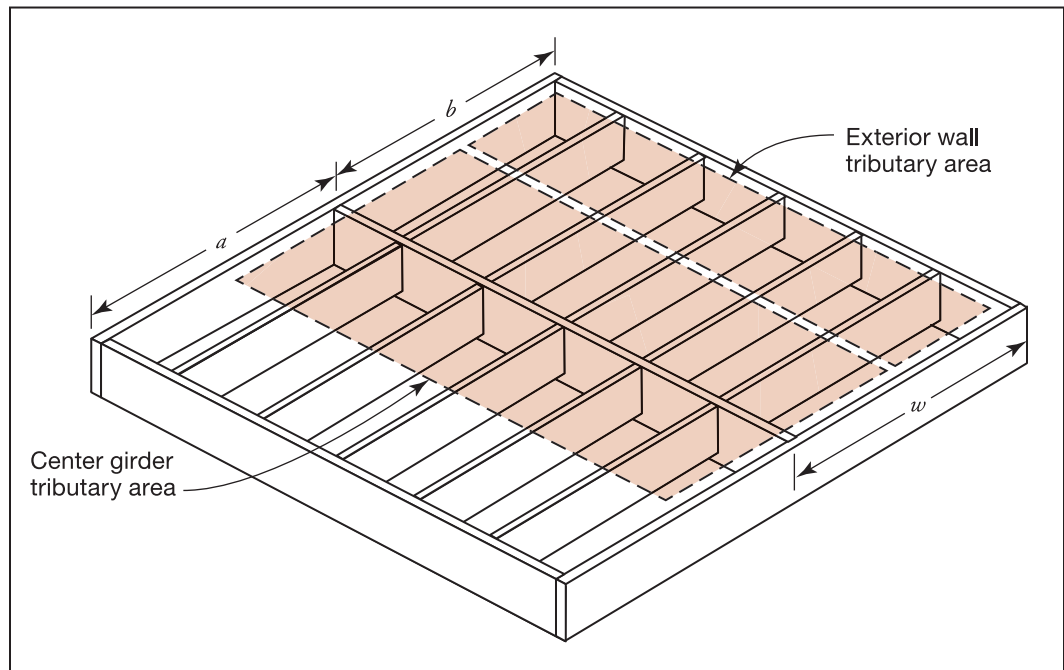

Figure 5-7.  
Wall/girder  
tributary area





### EQUATION 5-9: CALCULATION OF WALL/COLUMN LOADS

$$TL_{dis} = (DL + LL + SL)A_t \quad (\text{Eq. 5-9})$$

where:

$TL_{dis}$  = total dead, live, and snow loads acting on a specific wall or column (lb)

$DL$  = dead load (lb/ft<sup>2</sup>); see Figure 5-5

$LL$  = live load (lb/ft<sup>2</sup>); see Equation 5-5

$SL$  = snow load (lb/ft<sup>2</sup>); taken from building code

$A_t$  = tributary area of the wall or column (ft<sup>2</sup>) taken from Equations 5-6 and 5-8  
(when analyzing walls, use  $A_w$  instead of  $A_t$ )

**Step 4:** Calculate the self weight of the wall or column. Add any overbearing soil and foundation weight to the total. This information can be taken from the calculation worksheet shown in Figure 5-5.



### EQUATION 5-10: CALCULATION OF WALL/COLUMN LOADS

$$W_{self} = (SA \times W_u) + OSW + FW \quad (\text{Eq. 5-10})$$

where:

$W_{self}$  = self weight of the component (lb)

$SA$  = section area of the component (ft<sup>2</sup>)

$W_u$  = unit weight of the component (lb/ft<sup>2</sup> of surface)

$OSW$  = overbearing soil weight (lb)

$FW$  = foundation weight (lb)



### EQUATION 5-11: CALCULATION OF TOTAL LOAD CARRIED BY THE WALL OR COLUMN TO THE FOOTING OR FOUNDATION

$$TL = W_{self} + TL_{dis} \quad (\text{Eq. 5-11})$$

where:

$TL$  = total load carried by the wall or column to the footing or foundation (lb)

$W_{self}$  = self weight of the component (lb)

$TL_{dis}$  = total dead, live, and snow loads acting on a specific wall or column (lb)

**Step 5:** Add all the above calculated loads to find the load carried by the wall or column to the foundation or footing.

#### 5.2.11 Capacity versus Loading

The next step is to examine the capacity of the existing foundation component or system versus the expected loading from a combination of dead, live, flood, wind, snow, and seismic loads. This analysis will provide an initial estimate of the magnitude of foundation modifications necessary to accomplish an elevation or relocation project.

The IBC and IRC require the analysis of a variety of loading conditions and then base the capacity determination on the loading condition that presents the most unfavorable effects on the foundation or structural member concerned.

It is the purpose of the load combinations to identify critical stresses in structural members (or nonstructural members) and critical conditions used to design the support system. Since every conceivable situation cannot be covered by standard load cases, sound engineering judgment must be used.

#### 5.2.12 Load Combination Scenarios

ASCE 7-10 prescribes how to analyze flood loads in concert with other loading conditions. This guidance involves the use of two methods: allowable stress design and strength design. In the case of allowable stress design, design specifications define allowable stresses that may not be exceeded by load effects due to unfactored loads (i.e., allowable stresses contain a factor of safety).



#### CROSS REFERENCE

Designers should refer to ASCE 7 when conducting load combination analysis.

In strength design, design specifications provide load factors, and, in some instances, resistant factors.

The analysis of loading conditions may be checked using either method provided that method is used exclusively for proportioning elements of that construction material.

The designer should consult ASCE 7-10 for guidance in analyzing the multi-hazard loading conditions.

The following symbols are used in defining the various load combinations.

$D$  = Dead Load

$E$  = Earthquake Load

$F$  = Load due to fluids with well-defined pressures and maximum heights

$F_a$  = Flood Load

$H$  = Load due to lateral earth pressure, ground water pressure, or pressure of bulk materials

$L$  = Live Load

$L_r$  = Roof Live Load

$R$  = Rain Load

$S$  = Snow Load

$T$  = Self-Straining Force

$W$  = Wind Load

These symbols are based upon information from ASCE 7-10 but do not match exactly as several symbols had to be revised to accommodate symbols already used in this manual. Refer to ASCE 7-10 for clarification and additional information.

### 5.2.13 Strength Design Method

When combining loads using the strength design methodology, structures, components, and foundations should be designed so that their strength equals or exceeds the effects of the factored loads in the following combinations:

1.  $1.4D$
2.  $1.2D + 1.6L + 0.5(L_r \text{ or } S \text{ or } R)$
3.  $1.2D + 1.6(L_r \text{ or } S \text{ or } R) + (L \text{ or } 0.5W)$
4.  $1.2D + 1.0W + L + 0.5(L_r \text{ or } S \text{ or } R)$
5.  $1.2D + 1.0E + L + 0.2S$
6.  $0.9D + 1.0W$
7.  $0.9D + 1.0E$



**Exceptions:**

1. The load factor on  $L$  in combinations (3), (4), and (5) is permitted to equal 0.5 for all occupancies in which  $L_o$  in Table 4-1 of ASCE 7-10 is less than or equal to 100 lb/ft<sup>2</sup>, with the exception of garages or areas occupied as places of public assembly.
2. In combinations (2), (4), and (5), the companion load  $S$  shall be taken as either the flat roof snow load ( $p_f$ ) or the sloped roof snow load ( $p_s$ ).

Where fluid loads  $F$  are present, they shall be included with the same load factor as dead load  $D$  in combinations (1 through 5 and 7).

Where loads  $H$  are present, they shall be included as follows:

1. Where the effect of  $H$  adds to the primary variable load effect, include  $H$  with a load factor of 1.6.
2. Where the effect of  $H$  resists the primary variable load effect, include  $H$  with a load factor of 0.9 where the load is permanent or a load factor of 0 for all other conditions.

Effects of one or more loads not acting should be investigated. The most unfavorable effects from both wind and earthquake loads should be investigated, where appropriate, but they need not be considered to act simultaneously. Refer to Section 12.4 of ASCE 7-10 for specific definition of the earthquake load effect  $E$ . Each relevant strength limit state shall be investigated.

When a structure is located in a flood zone, the following load combinations should be considered in addition to the basic combinations in Section 2.3.1 of ASCE 7-10:

- in Zone V or Coastal A Zones,  $1.0W$  in combinations (4) and (6) shall be replaced by  $1.0W + 1.0F_a$ .
- in Zone A in noncoastal areas,  $1.0W$  in combinations (4) and (6) shall be replaced by  $0.5W + 1.0F_a$ .

This material is taken directly from ASCE 7-10.

The guidance in ASCE 7-10 Section 2.3 for Strength Design indicates which load combinations the flood load should be applied to. In the portion of Zone A landward of the LiMWA, the flood load  $F_a$  could be either hydrostatic or hydrodynamic loads. Both of these loads could be lateral loads; only hydrostatic will be a vertical load (buoyancy). When designing for global forces that will create overturning, sliding or uplift reactions,  $F_a$  should be the flood load that creates the most restrictive condition. In the case of sliding and overturning,  $F_a$  should be determined by the type of flooding expected. Hydrostatic forces will govern if the flooding is primarily standing water possibly saturating the ground surrounding a foundation; hydrodynamic forces will govern if the flooding is primarily from moving water.

When designing a building element such as a foundation,  $F_a$  should be the greatest of the flood forces that affect that element ( $F_{sta}$  or  $F_{dyn}$ ) +  $F_i$  (impact loads on that element acting at the stillwater level). The combination of these loads must be used to develop the required resistance that must be provided by the building element.

See Section 8.5.12 of FEMA P-55, *Coastal Construction Manual* (FEMA, 2011) for more guidance regarding incorporating flood loads into load combination equations.

### 5.2.14 Allowable Stress Method

When combining loads using the allowable stress method, the loads should be considered to act in the following combinations, whichever produces the most unfavorable effect on the building, foundation, or structural member being considered. This material is taken directly from ASCE 7-10.

1.  $D$
2.  $D + L$
3.  $D + (L_r \text{ or } S \text{ or } R)$
4.  $D + 0.75L + 0.75(L_r \text{ or } S \text{ or } R)$
5.  $D + (0.6W + 0.7E)$
- 6a.  $D + 0.75L + 0.75(0.6W) + 0.75(L_r \text{ or } S \text{ or } R)$
- 6b.  $D + 0.75L + 0.75(0.7E) + 0.75S$
7.  $0.6D + 0.6W$
8.  $0.6D + 0.7E$

#### Exceptions:

1. In combinations (4) and (6), the companion load  $S$  shall be taken as either the flat roof snow load ( $p_f$ ) or the sloped roof snow load ( $p_s$ ).
2. For non-building structures, in which the wind load is determined from force coefficients,  $C_{fm}$  identified in Figures 29.5-1, 29.5-2, and 29.5-3 of ASCE 7-10, and the projected area contributing wind force to a foundation element exceeds 1,000 square feet on either a vertical or horizontal plane, it shall be permitted to replace  $W$  with  $0.9W$  in combination (7) for design of the foundation, excluding anchorage of the structure to foundation.
3. It shall be permitted to replace  $0.6D$  with  $0.9D$  in combination (8) for the design of Special Reinforced Masonry Shear Walls, where the walls satisfy the requirement of Section 14.4.2 of ASCE 7-10.

Where fluid loads  $F$  are present, they shall be included in combinations (1) through (6) and (8) with the same factor as that used for dead load  $D$ .

Where load  $H$  is present, it shall be included as follows:

1. Where the effect of  $H$  adds to the primary variable load effect, include  $H$  with a load factor of 1.0.
2. Where the effect of  $H$  resists the primary variable load effect, include  $H$  with a load factor of 0.6 where the load is permanent or a load factor of 0 for all other conditions.

The most unfavorable effects from both wind and earthquake loads should be considered, where appropriate, but they need not be assumed to act simultaneously. Refer to Sections 1.4 and 12.4 of ASCE 7-10 for specific definition of the earthquake load effect  $E$ . Increases in allowable stress shall not be used with the loads or

load combinations given in ASCE 7-10 unless it can be demonstrated that such an increase is justified by structural behavior caused by rate or duration of load.

Buildings and other structures should be designed so that the overturning moment due to lateral forces (wind or flood) acting singly or in combination does not exceed two-thirds of the dead load stabilizing moment unless the building or structure is anchored to resist the excess moment. The base shear due to lateral forces should not exceed two-thirds of the total resisting force due to friction and adhesion unless the building or structure is anchored to resist the excess sliding force. Stress reversals should be accounted for where the effects of design loads counteract one another in a structural member or joint.

When a structure is located in a flood zone, the following load combinations should be considered in addition to the basic combinations in Section 2.4.1 of ASCE 7-10:

- in Zone V or Coastal A Zone,  $1.5F_a$  should be added to load combinations (5), (6), and (7) and E should be set equal to zero in (5) and (6); and
- in Zone A in noncoastal areas,  $0.75F_a$  should be added to load combinations (5), (6), and (7) and E should be set equal to zero in (5) and (6).

ASCE 7-10 Section 2.4 for Allowable Stress Design indicates which load combinations the flood load should be applied to, as discussed above in Section 5.2.13. Additional details are also provided in Section 8.5.12 of FEMA P-55 (FEMA, 2011).

Analyzing the existing structure's capacity to resist the expected loads is sometimes a long and tedious process, but it must be done to ensure that the structure will be able to withstand the additional loadings associated with various retrofitting measures.

The objective of this analysis is to verify that:

- the existing structure is able to withstand the anticipated loadings due to the retrofitting measure being considered; or
- the existing structure is unable to withstand the anticipated loadings due to the retrofitting measure being considered and requires reinforcement or other structural modification.

If these conditions are not met, then the retrofitting measure should be eliminated from consideration.

Using the information presented in this chapter, the designer should be able to conduct the analyses to implement the stated objective and identify the measures/modifications that must be designed.



# 5D Dry Floodproofing

Dry floodproofing measures can be described as a combination of operations plans, adjustments, alterations, and/or additions to buildings that lower the potential for flood damage by reducing the frequency of floodwaters that enter the structure. Please note that dry floodproofing is not allowed by FEMA for new or substantially improved or damaged residential structures located in the SFHA. Dry floodproofing should be only considered in limited instances and only for short duration flooding of a few hours. A structural engineer should always evaluate the structure to determine whether the wall system and floor system can resist the hydrostatic and other loads. These loads may cause the failure of a wall system during a flooding event, resulting in significant structural damage. Regardless of the outcome of load calculations, owners should consider the loads associated with short duration flooding prior to beginning a retrofit project. Examples of dry floodproofing modifications include:

- installation of watertight shields for doors and windows;
- reinforcement of walls to withstand floodwater pressures and impact forces generated by floating debris;
- use of membranes and other sealants to reduce seepage of floodwaters through walls and wall penetrations;
- installation of drainage collection systems and sump pumps to control interior water levels, collect seepage, and manage hydrostatic pressures on the slab and walls;
- installation of check valves to prevent the backflow of floodwaters or sewage flows through drains; and
- anchoring of the building to resist flotation, and lateral movement.



## WARNING

Dry floodproofing is not allowed by FEMA for new or substantially improved or damaged residential structures located in the floodplain.

Buildings that are dry floodproofed may be subject to enormous hydrostatic and imbalanced forces against the foundation and exterior walls and floor surfaces. As was illustrated in Chapter 4, hydrostatic and saturated soil pressures increase with the depth of flooding. For that reason, typical residential foundation walls have severe limitations with regard to the use of dry floodproofing measures. Therefore a primary design consideration for dry floodproofing is the determination of the ability of the existing structure (foundation walls, floor system, and exterior walls) to withstand the forces from the design flood event. If the structure's strength is found to be inadequate, decisions must be made about how to achieve the design level of performance. There are typically several ways to improve the structural performance of a structure, each with varying effectiveness and cost.

This section discusses the approach to dry floodproofing (see Figure 5D-1). The process of dry floodproofing involves: determining design flood protection level, evaluation of the structural systems for strength and suitability for dry floodproofing, evaluation, selection of sealants, shields, drainage collection systems, sump pumps, and backflow valves and the provision of emergency power to operate necessary drainage systems. The designer must understand that some form of dry floodproofing measures may be needed as part of most retrofitting measures. Each component of the system will need to work with the other parts to provide the desired level of flood protection.

An initial, basic and instrumental part of a successful dry floodproofing measure is the development and use of Emergency Operations and Maintenance Plan. Since these dry floodproofing measures require an active role of systems and owner operators and are not passive, there are many more components that must be tested, serviced, maintained, and retired when appropriate. These systems will need to be evaluated annually for suitability, and function, some items with limited shelf life (caulks and sealants) will need to be replaced regularly. Some of the important elements of these plans are presented below.

**NOTE**

FEMA strongly encourages that flood retrofits provide protection to the DFE (or BFE plus 1 foot, whichever is higher). However, in some situations a lower flood-protection level may be appropriate. Homeowners and design professionals should meet with a local building official to discuss the selected retrofit measure and the elevation to which it will protect the home. The text and examples in this manual assume flood protection measures will be implemented to the DFE.

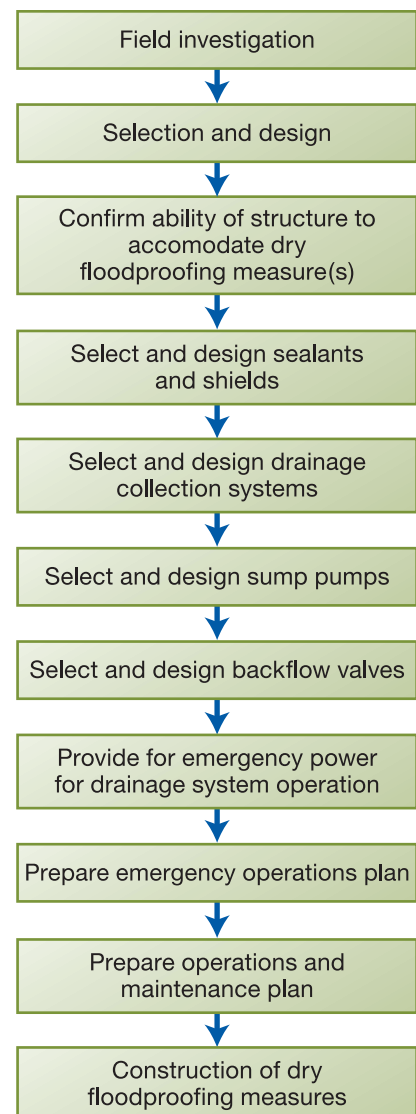

**Figure 5D-1.**  
Process of selection and design for dry floodproofing

## 5D.1 Emergency Operations Plan

Two critical aspects of an effective emergency operations plan are a plan for notifying homeowners (community flood warning system) of the need to install dry floodproofing components and the chain of command/resources (human intervention) to carry out the installation of reactive parts of the dry floodproofing measures. To ensure a more favorable outcome from a flood event, a suitable evacuation plan is also needed as well as periodic training in the installation of dry floodproofing measures.

## 5D.2 Inspection and Maintenance Plan

Since much of the dry floodproofing system is active, these pieces require some degree of periodic annual maintenance and inspection to ensure that all components will operate properly under flood conditions. Components that should be inspected as part of an annual maintenance, inspection, and replacement program include:

- all mechanical equipment such as sump pumps, switches, piping, valves and generators;
- flood shields, to ensure that they fit properly and that the gaskets and seals are in good working order, properly labeled, and stored in an accessible area; and
- sealed walls and wall penetrations, for cracks and potential leaks.

## 5D.3 Sealants and Shields

Sealants and shields are methods that can be used to protect a structure from low-level flooding. Mini-floodwalls (low level) can be used as an alternative to shields for protection of windows, window wells, or basement doors. These systems are easily installed and can be inexpensive in relation to other measures such as elevation or relocation. However, by sealing (closing) a structure against flood inundation, the owner must realize that, in most cases, the typical building will not be capable of resisting the loads generated by more than a few feet of water. The level of flooding the building can resist should be determined by a competent design professional. There will be a point beyond which the sealants and shields will do more harm than good and the owner must allow the building to flood to prevent structural failure from unequalized forces.

The USACE National Flood Proofing Committee has investigated the effect of various depths of water on masonry walls, discussed in their report titled *Floodproofing Test* (USACE, 1988). The results of their work show that, as a general rule, a maximum of 3 feet of water should be allowed on a non-reinforced concrete block wall that has not previously been designed and constructed to withstand flood loads. Therefore, application of sealants and shields should involve a determination of the structural soundness of a building, the walls, and the floor slab, as well as their corresponding ability to resist flood and flood-related loads.



### CROSS REFERENCE

For additional information on dry floodproofing, refer to FEMA's NFIP Technical Bulletin 3-93, *Non-Residential Floodproofing—Requirements and Certification for Buildings Located in Special Flood Hazard Areas in Accordance with the National Flood Insurance Program* (FEMA, 1993).



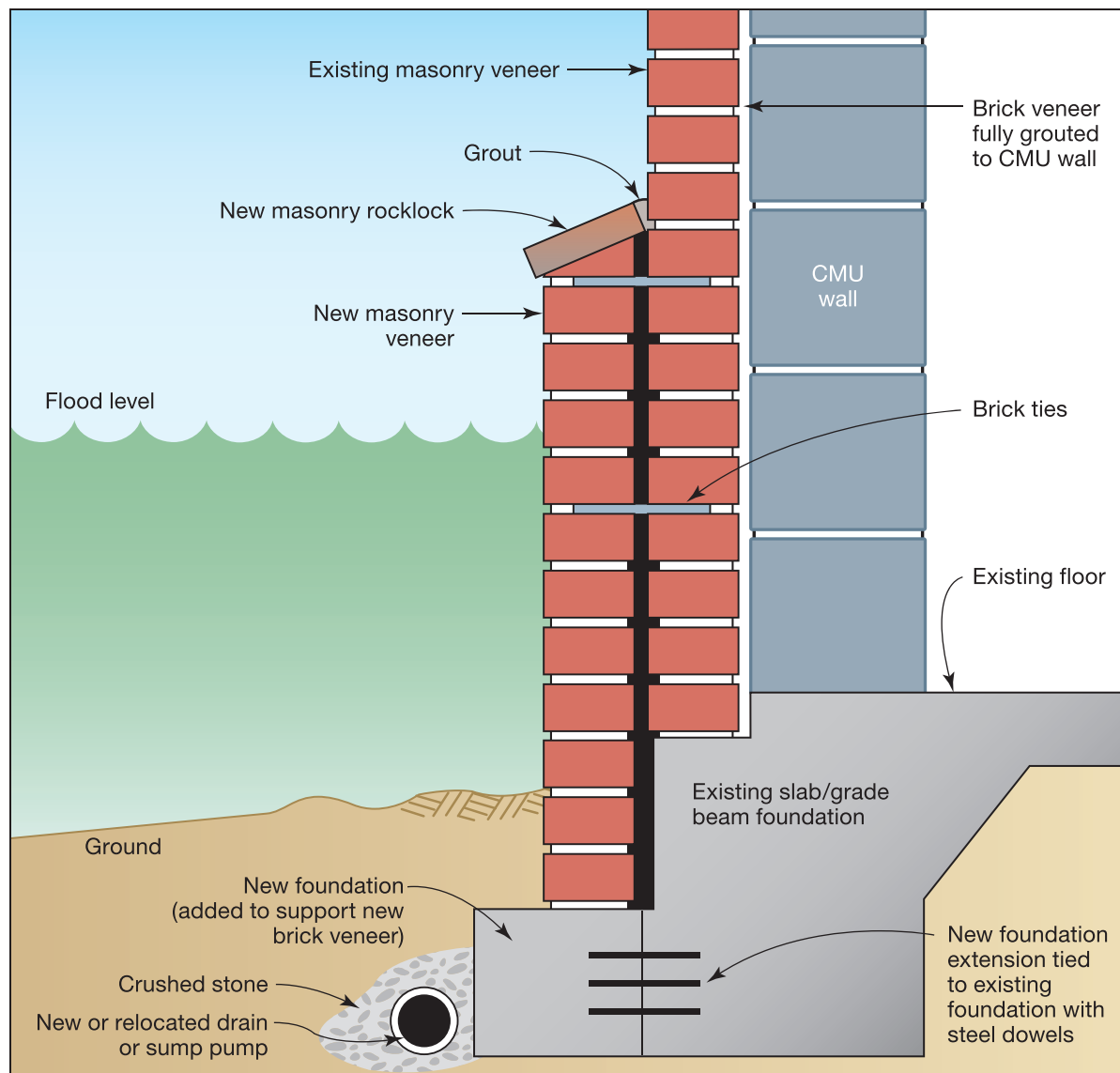

**Figure 5D-2.** A way to seal an existing brick-faced wall is to add an additional layer of brick with a seal in between. Please note that weep holes and wick drains work both ways to allow for moisture passage from high to low pressure. Weepholes and flashing should be located above the DFE, and the veneer below the DFE should be fully grouted.

Sealants include compounds that are applied directly to the surface of the structure to seal exterior walls and floors (see Figure 5D-2), or a wrap that is anchored to the exterior wall or foundation at or below the ground and attached to the wall above grade during flooding (see Figure 5D-3). The owner may need to strengthen the existing building to aid in resisting the very large flood-induced loads. Because of the large hydrostatic loads that can be exerted on the wall system and floor slab, it is imperative that an analysis of the wall system be conducted by a design professional and a maximum allowable flood height be determined. Slabs and concrete walls may be analyzed using ACI 318-08, *Building Code Requirements for Structural Concrete and Commentary* (ACI, 2008a), or ACI 530-08, *Building Code Requirements for Masonry Structures and Specifications for Masonry Structures* (ACI, 2008b), while wood framed structures may be evaluated using the

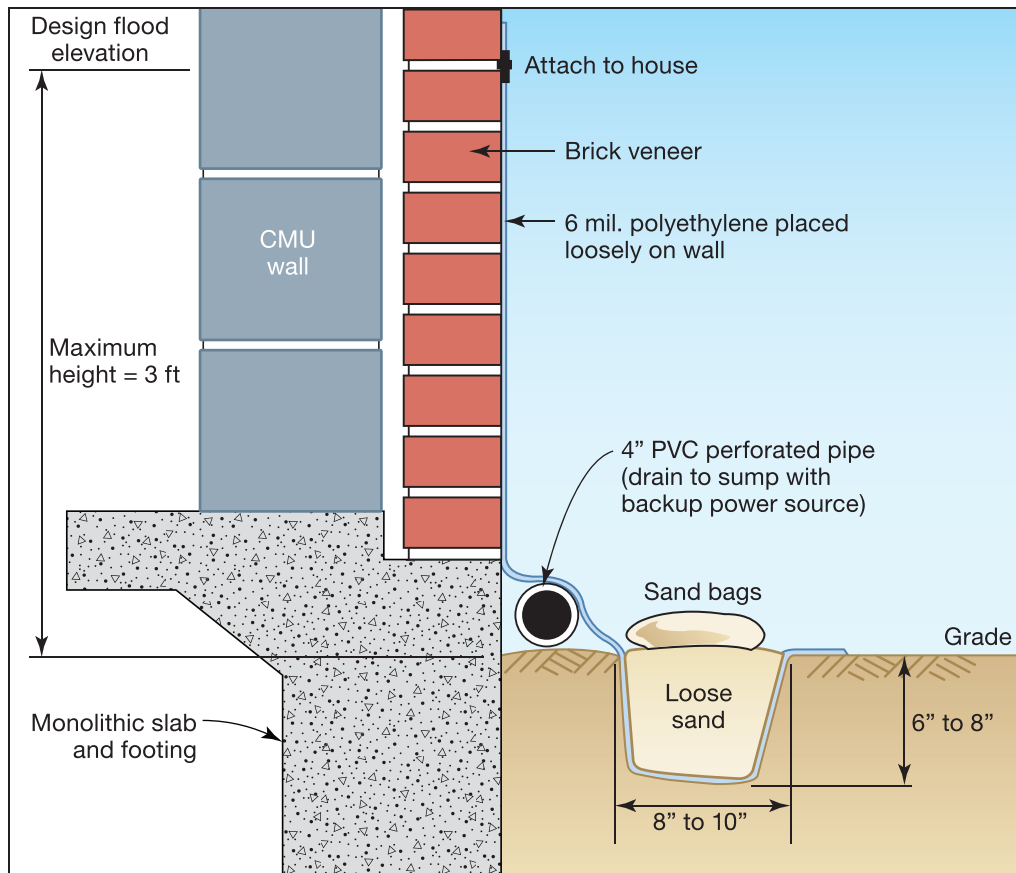

**Figure 5D-3.** A wrapped house sealing system can be used to protect against fast transient low-level flooding. This is recommended primarily for concrete or masonry substructures.

latest edition of the American Approved National Standard (ANSI)/American Forest & Paper Association (AF&PA) *National Design Standard for Wood Construction* (ANSI/AF&PA NDS, 2005). The costs and obstacles associated with retrofitting an existing building to resist the hydrostatic loads may indicate that other floodproofing measures may be more appropriate.

Any dry floodproofing system will have some water infiltration, and the owner will need a dewatering system capable of removing the water. Due to this infiltration through exterior walls and floors and percolation of the water around ground anchored wraps, these systems are not recommended for situations where floodwater is in contact with the building for more than 12-24 hours. Underlying soils often dictate the allowable period of inundation before water starts to percolate through the house perimeter and envelope sealant system. In very permeable soils, this can be a matter of a few hours. Determining if it is possible to pump the water away from the house by conventional means or if seepage rates will overwhelm standard sump pumps is also important.



**CROSS REFERENCE**

Floodwalls and floodwall closures are discussed in Chapter 5F.

Shields are watertight structural systems that bridge the openings in a structure's exterior walls. They work in tandem with the sealants to resist water penetration. Steel, aluminum, and, in limited applications, marine-grade plywood are some of the materials that can be used to fabricate shields. These features are temporary in most cases, but may be permanent when in the form of a hinged plate or a mini-floodwall at a subgrade opening. Shields transfer flood-induced forces into the adjacent structure components and, like sealants, can overstress the structural capabilities of the building (see Figures 5D-4 through 5D-7).

The use of sealants and shields requires that the house have a well-developed interior drain system to collect the inevitable leaks and seepage that will develop. In some instances, such a system may require establishing drains around footings and slabs to direct seepage to a central collection point where it can be removed by a sump pump.

Additionally, a building employing sealants and shields will usually need backflow devices and other measures designed to eliminate flooding through utility system components. Additional information on this topic is presented later in this section (see Figure 5D-8).

**Figure 5D-4.**  
A shield hinged at its bottom could prevent low-level flooding from entering a garage or driveway.



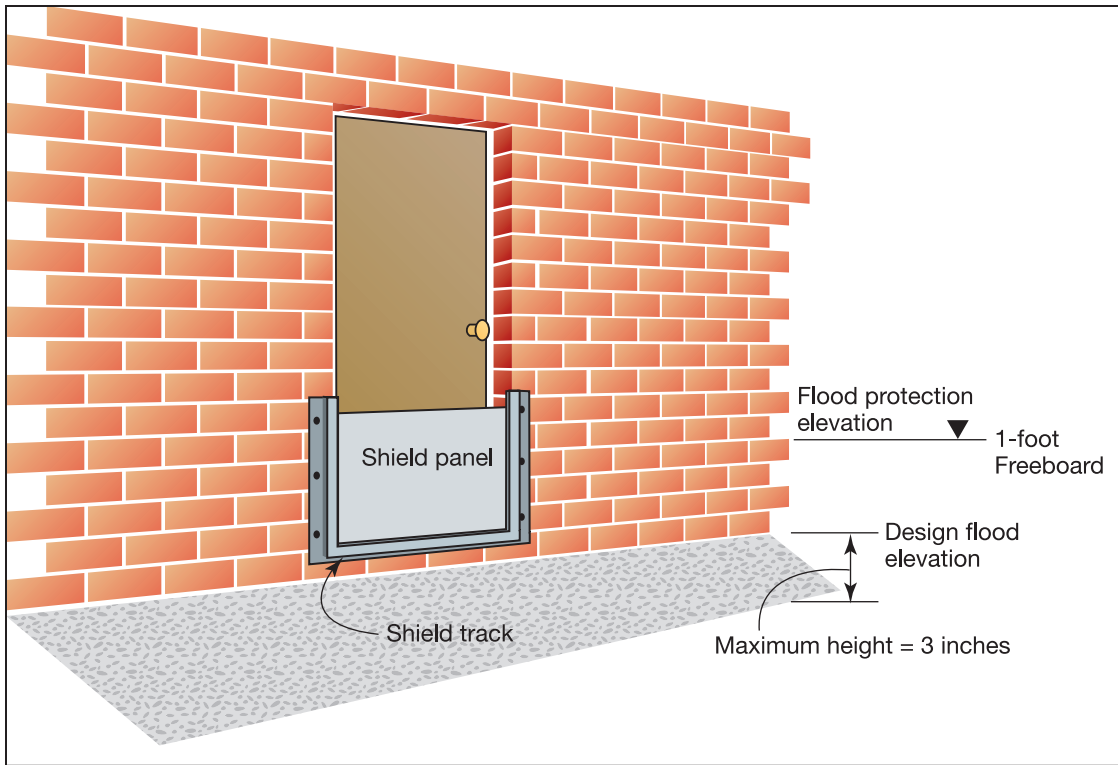

Figure 5D-5. A door opening may be closed using a variety of materials for shields.

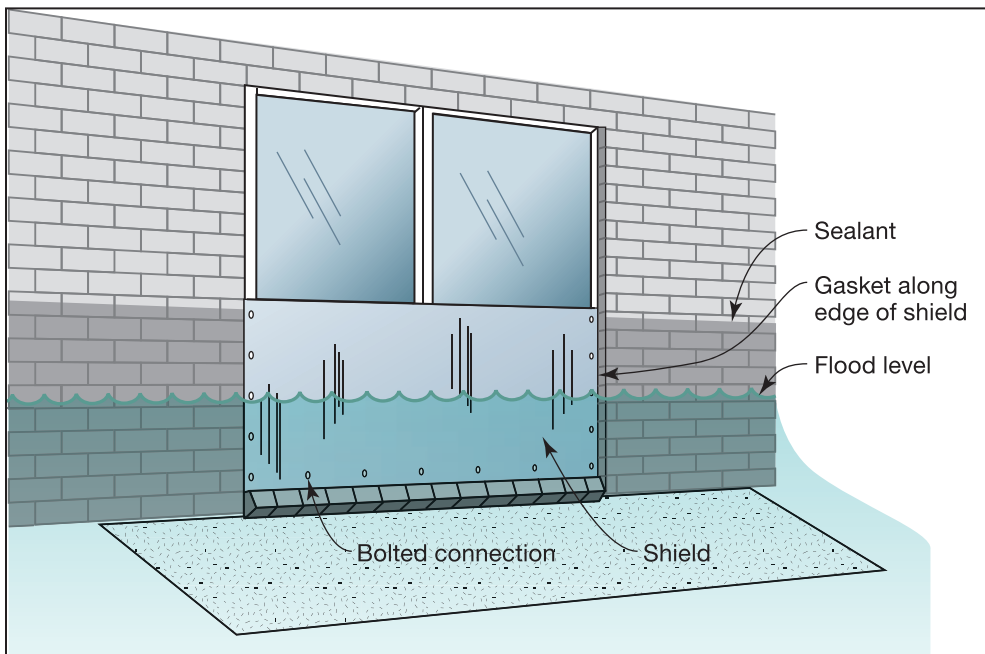

Figure 5D-6. A shield can help prevent low-level flooding from entering through a doorway.

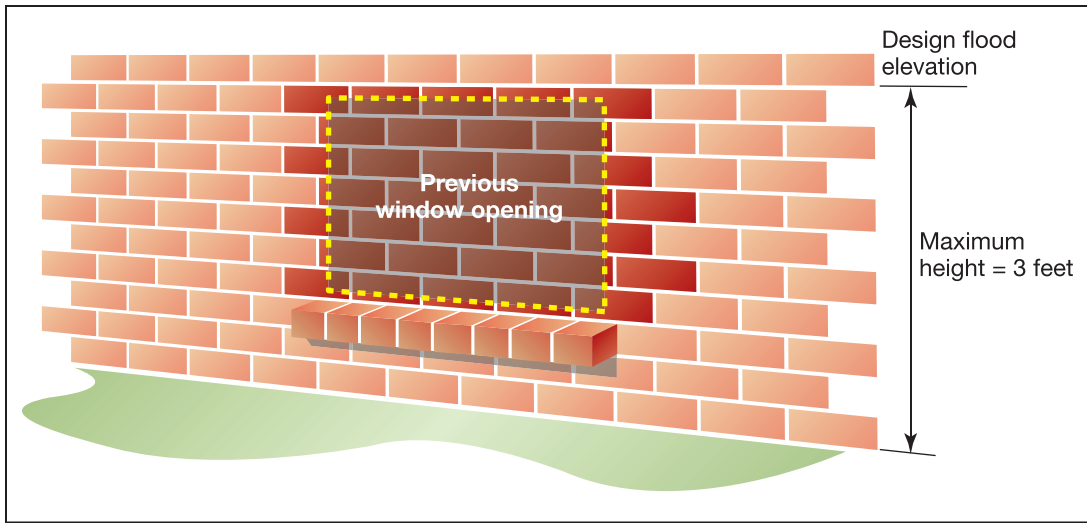

Figure 5D-7. Where a window is exposed to a flood, bricking up the opening could eliminate the hazard.

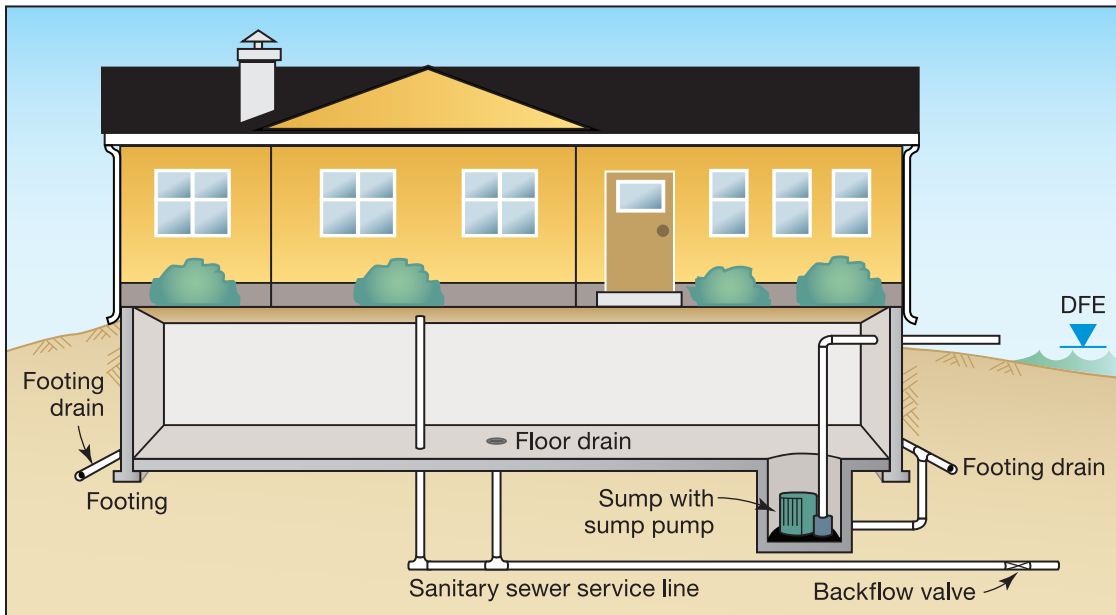

Figure 5D-8. Dry floodproofed homes should have an effective drainage system around footings and slabs to reduce water pressure on foundation walls and basements. The drainage systems can be extremely vulnerable to hydrostatic forces under high flooding conditions.

## 5D.4 Field Investigation

In addition to, or during consideration of, the field investigation information compiled on the existing building/building systems data sheet (Figures 5-2 and 5-3), the designer should concentrate on collecting or verifying the following items:

- condition of existing superstructure, foundation, and footing;
- determination of existing materials used in the house to calculate dead weight;
- determination of type of soil, lateral earth pressures, permeability, and seepage potential;
- building's lateral stability system and adequacy of structural load transfer connections;
- foundation wall, footing, and slab information (thicknesses, reinforcement, condition spans, etc.);
- number, size, and location of openings or penetrations below the DFE;
- expected flood warning time;
- evidence of previous, and potential for continued, settlement, which could cause cracking after sealant is applied;
- estimates of leakage through the exterior walls and floor;
- manufacturer's data to determine applicability of sealant materials in terms of above- and below-grade applications, and duration of water resistance;
- potential anchorage to secure wrapped systems;
- preliminary selection of shield material to be used based upon the length and height of the openings and duration of flooding; and
- preliminary selection of type of shield anchorage (hinged, slotted track, bolted, etc.) to be utilized by considering accessibility, ease of installation, and amount of time available for installation.

Using this information, a designer should be able to determine if a system of sealants and shields is an option. Of course, further calculations or conditions may dictate otherwise, or that modifications should be made to accommodate the system. The designer can take the information gathered in the field and begin to develop type, size, and location alternatives.

Sealant alternatives include:

- cement- and asphalt-based coatings, epoxies and polyurethane-based caulks/sealants;
- membrane wraps such as polyurethane sheeting; and



### CROSS REFERENCE

For additional information concerning the performance of various sealant systems, refer to the USACE research study, *Flood Proofing Tests – Tests of Materials and Systems for Flood Proofing Structures* (USACE, 1988), and product evaluation reports prepared by model code groups or National Engineering Standards.



- brick veneers over a waterproof coating on the existing concrete or CMU block foundation; brick veneers below the DFE must be fully grouted.

Shield alternatives include:

- a permanent low wall to protect doors and window wells against low-level flooding;
- bricking in a nonessential opening with an impermeable membrane; and
- drop-in, bolted, and hinged shields that cover an opening in the existing structure.

### 5D.5 Confirm Structure is Designed to Accommodate Dry Floodproofing Measures

A critical step in the development of initial type, size, and location of the sealant and shield systems is to determine the ability of the existing superstructure and foundation to resist the expected flood- and non-flood-related forces. The flood forces are illustrated in Figure 5D-9 and the design process is illustrated in Figure 5D-10.

**Step 1:** Calculate flood and flood-related forces.

The calculation of flood and flood-related forces (hydrostatic, hydrodynamic, buoyancy, soil, and debris impact forces) as well as determination of seepage and interior drainage rates was presented in Chapter 4. The designer should account for any non-flood-related forces (i.e., wind, seismic, etc.) by incorporating those forces into Steps 2-6. The determination of non-flood related forces was presented in Chapter 4.

**Step 2:** Check flotation of the superstructure.

Residential structures that are determined to be watertight should be checked to ensure that the entire sub- and super-structure will not float. However, it is reasonable to assume that most residential construction will fail prior to flotation of the structure. This failure will most likely occur through the slab-on-grade breaking (heaving/cracking), a window or door failing inward, or extensive leakage through wall penetrations. Should

**Figure 5D-9.**  
Illustration of hydrostatic force

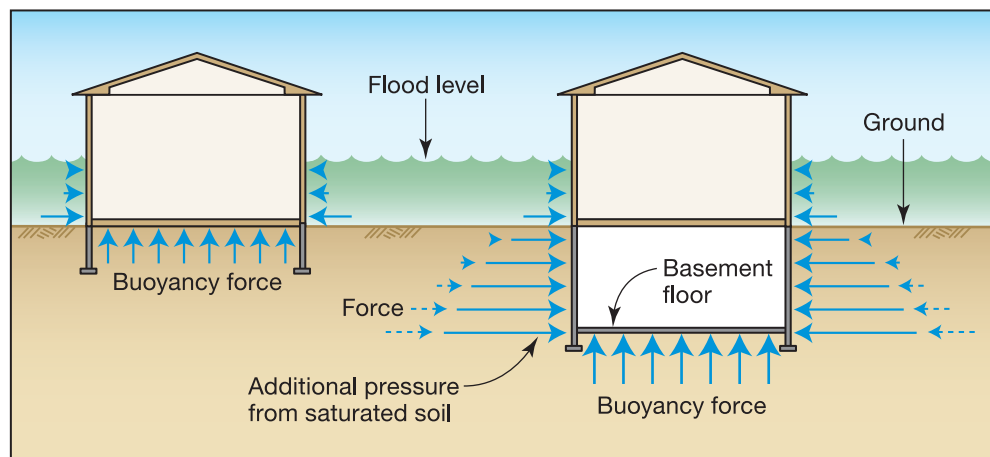

the designer wish to check the failure assumption, guidance is provided in Step 5. If floodwaters come into contact with a wood floor diaphragm (elevated floor or crawlspace home), the floor system/building superstructure should be checked for flotation (Figures 5D-11 and 5D-12).

Check the sum of the vertical hydrostatic (buoyancy) forces acting upward against the gravity forces (dead load) acting downward on the structure. The gravity forces acting downward should be greater than the buoyancy forces acting upward (Figure 5D-9). If this is not the case, the designer should consider choosing another floodproofing method or designing an anti-flotation system. The homeowner should make this decision based upon technical and cost information supplied by the designer.

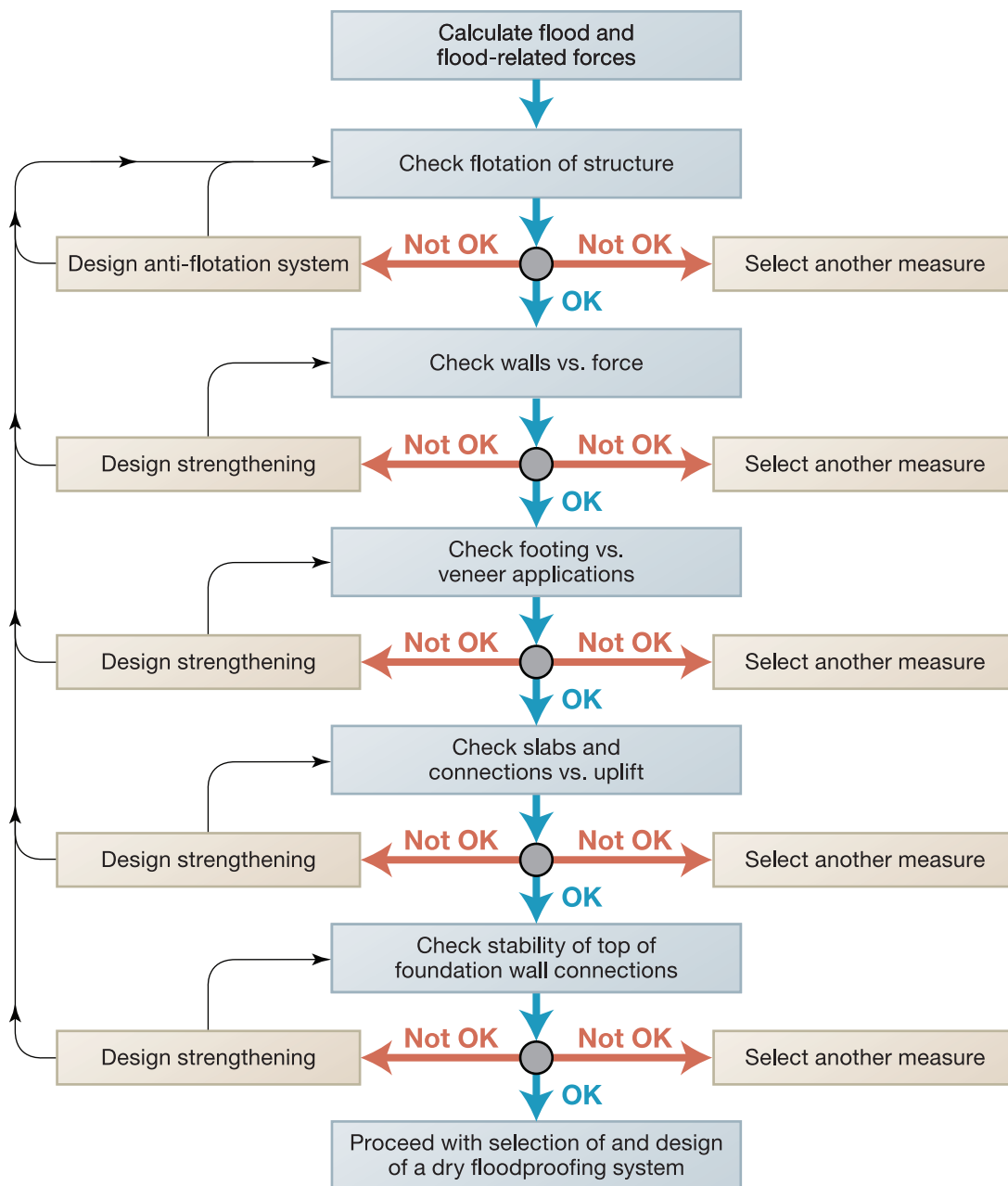

Figure 5D-10. Existing building structural evaluations



Figures 5D-11 and 5D-12. This house located in the SFHA was displaced from its foundation into the roadway adjacent to it. The photo on the right shows the house's original location.

**Step 3:** Check ability of walls to withstand expected forces.

Wall systems may benefit from the addition of products such as fiber reinforced polymers, grouting, or other retrofit measures, which may improve the ability of the wall to resist flood loads and reduce the susceptibility to leaking and seepage. Frames and connections for closures transfer the retained forces into the adjacent walls. Typically a vertical strip on each side of the opening must transfer the load up to a floor diaphragm and down to the floor or foundation. This “design strip,” shown in Figure 5D-13, must be capable of sustaining loads imposed on it and from the openings. The designer should consider all forces acting on the design strip, as well as the following additional considerations:

- a. Check design strip based on simple span, propped cantilever, cantilever, and other end conditions. Consider the moment forces into the foundation.
- b. Check design strip for bending and shear based on concrete, masonry, or other wall construction (Figure 5D-14).
- c. Consider the path of forces from shield into the design strip through the various connection alternatives including hinges, drop-in slots, frames, and others.
- d. The designer may want to refer to the American Institute of Steel Construction (AISC) Steel Manual, ACI documents for concrete and masonry construction, and other applicable codes and standards for more information on the ability of these materials to withstand expected flood and flood-related forces.



**NOTE**

The typical failure mode for a shield installation is the “kick-in” of the bottom connection where hydrostatic forces are the greatest.



**CROSS REFERENCE**

Refer to ACI 530, *Building Code Requirements for Masonry Structures* (ACI, 2008b), for design of reinforced masonry. Typically, the effective design strip width,  $b_{eff}$ , equals the minimum of:

1. center-to-center spacing,  $S$  (inches)
2. six times wall thickness,  $t_w$  (inches)
3. 72 inches

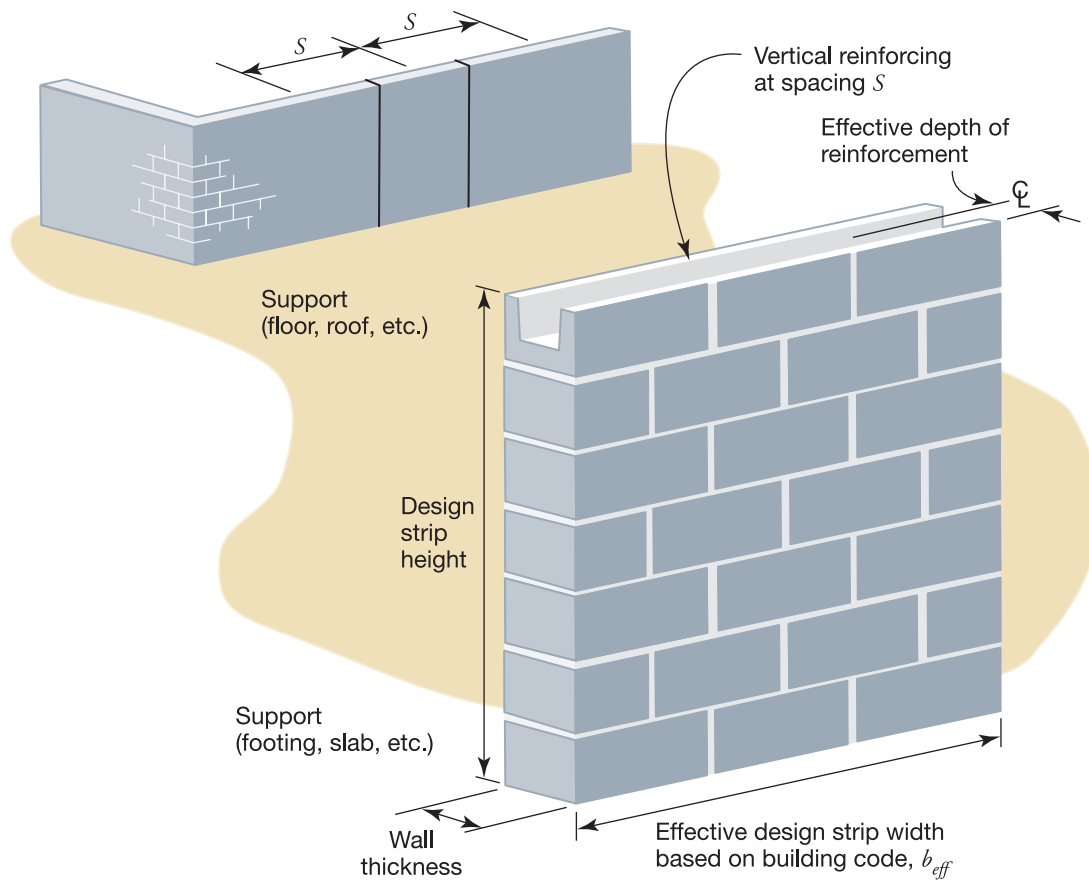

Figure 5D-13. Typical design strip for reinforced masonry



Figure 5D-14. This house’s foundation walls were not able to withstand the forces applied during or after the flood. Rebar would need to be added to help with reinforcement of the CMU foundation.

**Step 4:** Check ability of footing to support veneer applications.

The application of veneer to the exterior of an existing wall must be supported at the footing level. The designer should consider all forces acting on the existing footing, as well as the following additional considerations:

- a. Supporting the masonry veneer on an existing footing can add an eccentric load onto the footing and can create soil pressure problems. The designer should analyze the footing with the additional load considering all load combinations, including the flooded condition.
- b. The actual pressure on the footing should not overload the bearing capacity of the existing soils. Consult a geotechnical engineer, if necessary.
- c. The designer may want to refer to ACE 318-08, *Building Code Requirements for Structural Concrete and Commentary* (ACI, 2008a), various soils manuals/textbooks for detailed footing design, and applicable codes and standards.

**Step 5:** Check slab and connections against uplift forces.

As floodwaters rise around a structure, a vertical hydrostatic (buoyancy) force builds up beneath floor slabs. For floating slabs, this buoyancy force is resisted by the structure dead load and saturated soil above the footing; for keyed-in slabs, this buoyancy force is resisted by the structure dead load, and the flexural strength of the slab. These slabs must be capable of spanning from support to support with the load being applied beneath the slab (see Figure 5D-15). The designer should consider all forces acting on the existing slab and connections, as well as the following additional considerations:

**Figure 5D-15.**  
Typical slab uplift failure

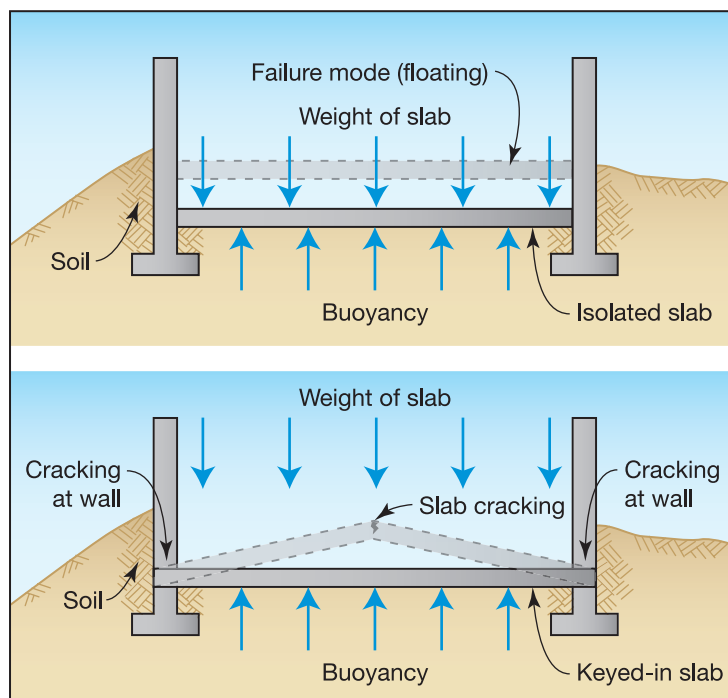



- a. Verify the existing slab conditions, including thickness, reinforcement (size and location), joint locations, existence of continuous slab beneath interior walls, existence of ductwork in slab, and edge conditions. If reinforcement and thickness are not easily determinable, make an assumption (conservative) based on consultation with the local building official or contractors.
- b. Confirm the slab design by checking reinforcement for bending and edge connection for shear load.

**Step 6:** Check stability of top of foundation wall connections.

Foundation walls may retain water in some situations. These walls must transfer the additional hydrostatic load down to the footing or slab and up to the floor diaphragm. The designer should consider all forces acting on the top of the existing foundation wall connections, as well as the following additional considerations:

- a. Verify existing wall conditions, including construction material, reinforcement, design conditions (simple span, propped cantilever, cantilever, and other end conditions), and connections.
- b. Connections between the wall and floor are of major importance in consideration of the wall stability. The designer should check the following:
  1. Masonry/concrete for shear from bolt;
  2. Anchor bolt for shear;
  3. Sill for bending from bolt loads; and
  4. Loads have a pathway out of the structure. Additional bracing and/or connectors may be required to support a load pathway out of the structure. Analyze superstructure and be cognizant that all sides may be loaded.
- c. The designer may want to refer to ACI 318-08, *Building Code Requirements for Structural Concrete and Commentary* (ACI, 2008a), for anchor bolts, and applicable codes and standards.

**Step 7:** Design foundation supplementation system, as required.

If the checks in Steps 2-6 determined that any structural members were unable to withstand expected flood and flood-related loads (wind, seismic, and other forces can be evaluated as presented in Chapter 4), the designer can either select another retrofitting measure or design foundation supplementation measures (see Figure 5D-16). These foundation supplementation measures could range from increasing the size of the footing to adding shoring to the foundation walls, or simply modifying the type, size, number, and location of connections. The homeowner should make this decision based upon technical and cost information supplied by the designer.

**Footing Reinforcing:** In some cases, the footings for walls must be modified to accommodate expected increased loadings. The following considerations should be taken into account during the design of this modification:

- a. The wall footing must be checked for the increased soil pressure and sliding. Moment and vertical loads from the wall above should be added.
- b. The footing may need more width and reinforcement to distribute these forces to the soil.



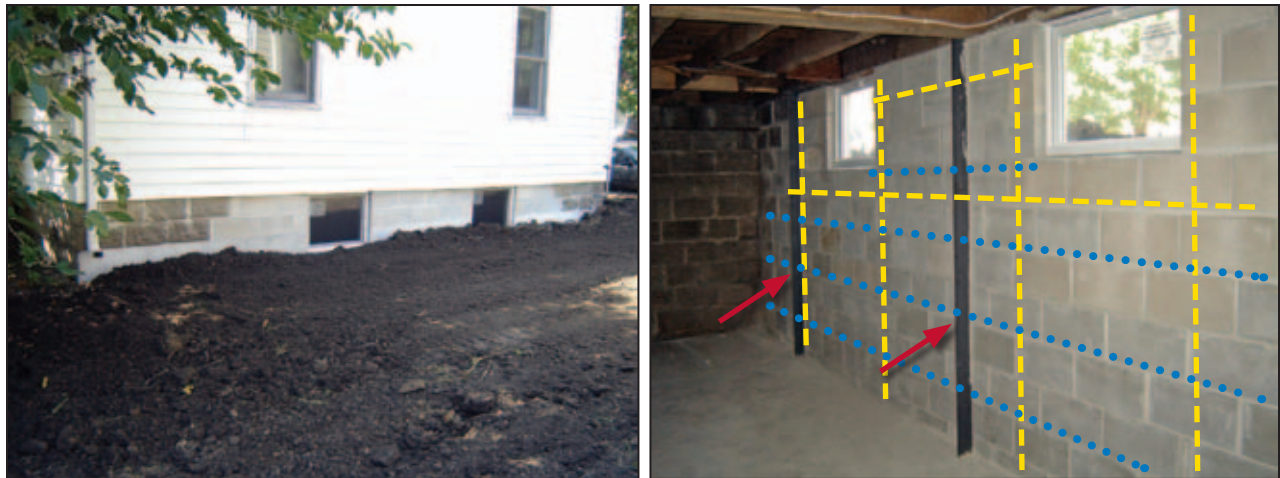

Figure 5D-16. This house's foundation was rebuilt after collapse from saturated soil forces after a flood. The blue lines on the wall indicate locations of internal wall joint reinforcing, the yellow lines indicate location of vertical reinforcing bars, and the exterior reinforcement can be seen in the pictures (red arrows).

- c. For some extreme cases (poor soils, high flood depths, flood-related wind, and/or earthquake loads), a geotechnical engineer may be required to accurately determine specific soil loads and response.
- d. The designer should consider multiple loading situations taking into account building dead and live loads that are transferred into the footing, utilizing whatever load combinations are necessary to design the footing safely and meet local building code requirements. Consider the materials used in the construction of the structure and how the entire house load is transferred into the foundation.
- e. The designer may want to refer to the ACI 318-08, *Building Code Requirements for Structural Concrete and Commentary* (ACI, 2008a) for footing design, recent texts for wall and footing design, and applicable codes and standards.



#### NOTE

Dry floodproofing measures are only as good as their weakest link (i.e., the connection to the existing structure). The designer should ensure that all appropriate details for making the connection watertight as well as allowing for the transfer of loads are developed.

**Step 8:** Repeat process in Steps 1-7 incorporating exterior wall foundation supplementation system.

Once the designer has determined that the existing structure and foundation are suitable for the application of sealants or shields, or that reinforcement can be added to make the existing superstructure and foundation suitable for the application of sealants or closures, the selection/design of a specific system can begin.

## 5D.6 Selection and Design of Sealant Systems

Once the determination is made that a foundation system can withstand the expected flood and flood-related forces, the selection of a sealant system is relatively straightforward and centers on the ability of

the manufacturer’s product to be compatible with the length and depth of flooding expected and the type of construction materials used in the structure.



**NOTE**

Actual test results of sealant product performance, if available, should be used to supplement the manufacturer’s literature. Sources of test results include model building code product evaluation reports, USACE *Flood Proofing Test – Tests of Materials and Systems for Flood Proofing Structures* (USACE, 1988), and local building code officials.

**5D.6.1 Coatings**

The selection of a coating follows the flow chart presented in Figure 5D-17. If additional structural reinforcing is required, it should be performed in accordance with the guidance presented in Section 5D.5.1.

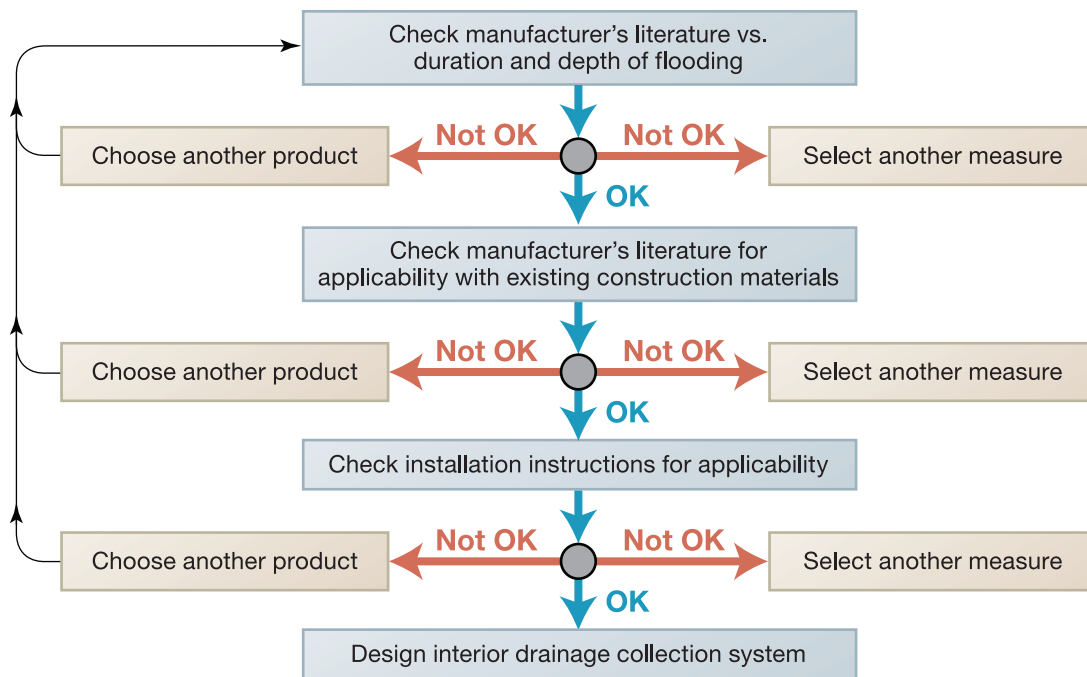

Figure 5D-17. Selection of sealants/coatings

**5D.6.2 Wrapped Systems**

The selection and design of a wrapped system follows Figure 5D-18. If additional structural reinforcing is required, it should be performed in accordance with the guidance presented in Section 5D.5.

**Step 1:** Select type and grade of material.

**Step 2:** Check manufacturer’s literature against duration and depth of flooding.

If flooding application is satisfactory, proceed with design; if not satisfactory, select another product or another method.

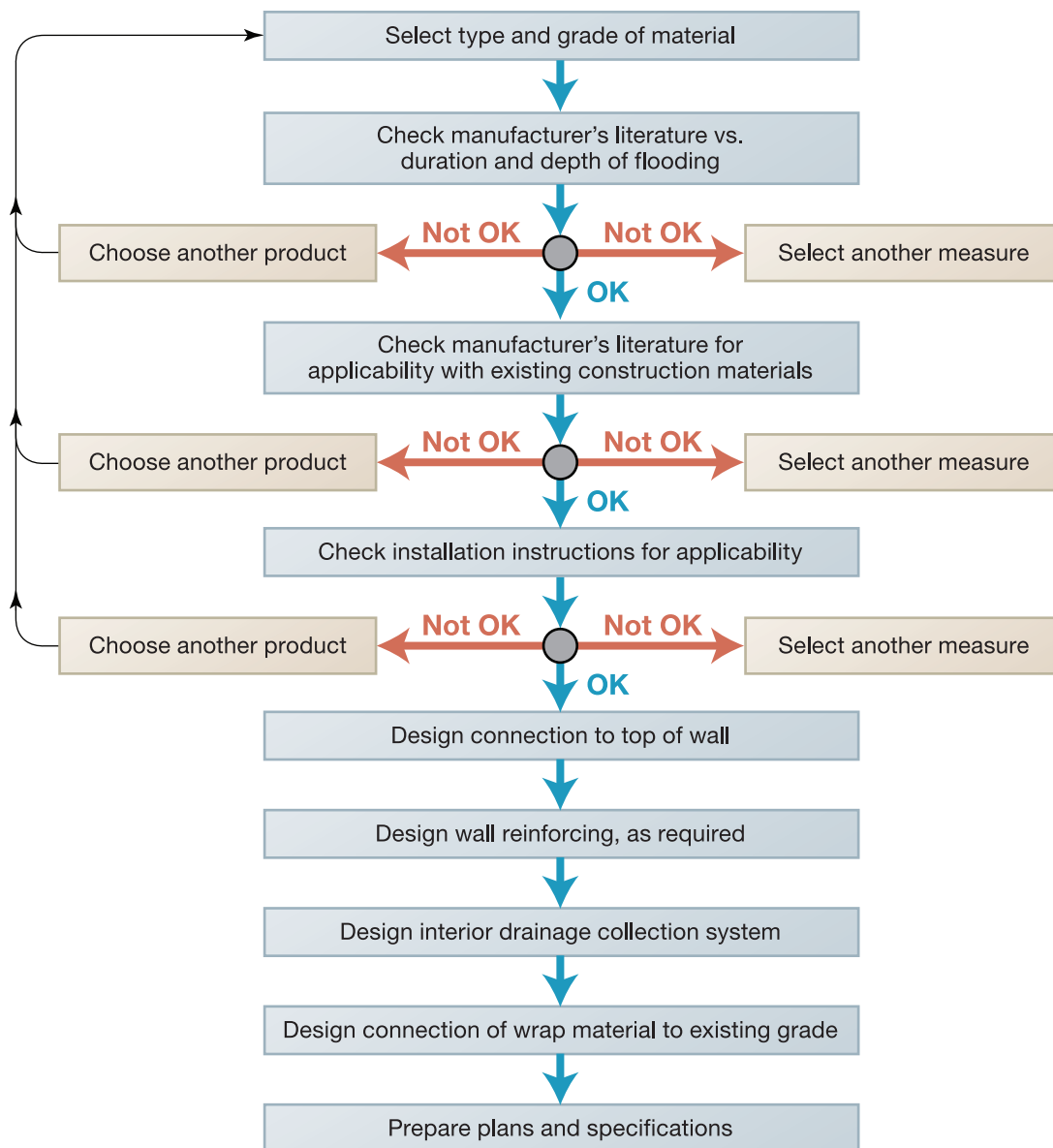

Figure 5D-18. Selection and design of wrapped sealant systems

**Step 3:** Check manufacturer’s literature for applicability to building materials. Rely on actual test results, if available.

If building materials application is satisfactory, proceed with design; if not satisfactory, select another product or another method. Manufacturer performance claims can be misleading. The designer should utilize actual test results rather than rely entirely on a manufacturer’s performance claim.

**Step 4:** Check installation instructions for applicability.



**NOTE**

For additional information concerning the performance of various sealant systems, refer to the USACE *Flood Proofing Tests – Tests of Materials and Systems for Flood Proofing Structures* (USACE, 1988), and product evaluation reports prepared by model code groups.

If installation procedure is satisfactory, proceed with design; if not satisfactory, select another product or another method.

**Step 5:** Design connection to top of wall.

Adding a wrap system onto an existing structure will require secure connections at both the top and bottom of the wrap. It is difficult to determine the actual loads imposed vertically on the wrap as this can vary, based upon the quality of the installation. Voids left from poor construction may force the wrap to carry the weight of the water and should be avoided (Figure 5D-19). The following considerations should be followed during selection and design of a top-of-wall connection system:

- a. Use a clamping system that uniformly supports the wrap. A small spacing on the connections and a member with some rigidity on the outside of the wrap can provide this needed support.
- b. The existing wall construction is an important consideration for these connections and can vary widely. Part of the connection may need to be a permanent part of the wall.

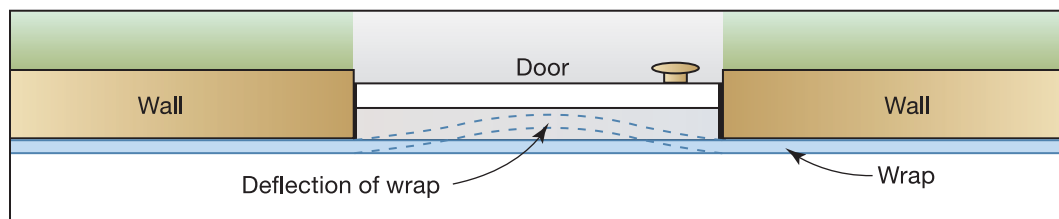

Figure 5D-19. Plan view of wall section

**Step 6:** Design foundation reinforcing.

Refer to Section 5D.5.1.

**Step 7:** Design drainage collection system.

Refer to Section 5D.9.

**Step 8:** Specify connection of wrapping to existing structure and existing grade.

Anchoring a wrap into the grade at the base of a wall will be the most important link in the wrap system. The following considerations should be followed during selection and design of a wrap to the existing grade connection system:

- a. A drain line between the wrap and the house is required to remove any water that leaks through the wrap or that seeps through the soil beneath the anchor.



**CROSS REFERENCE**

See Figure 5D-3 for details on wrapped system configuration.



**NOTE**

Wrap systems may be affected by freeze-thaw cycles. Careful installation in accordance with manufacturer instructions and evaluation of performance in frozen climates is advisable.

- b. As with the top-of-wall connection, wrap forces are difficult to determine. It is best to follow details that have worked in the past and are compatible to the specific structure.
- c. It is recommended that the end of the wrap be buried at least below the layer of topsoil. Additional ballast may be needed (sandbags, stone, etc.) to prevent wrap movement in a saturated and/or frozen soil condition.
- d. The designer may want to refer to the product literature for wrap material and applicable codes and standards.

### 5D.6.3 Brick Veneer Systems

The selection and design of a brick veneer sealant system follows Figure 5D-20 and has many components that are similar to the design of other sealant systems. A typical brick veneer sealant system is shown in Figure 5D-2. If additional structural reinforcing is required, it should be performed in accordance with the guidance presented in Section 5D-5.



#### CROSS REFERENCE

See Figure 5D-2 for details on brick veneer system configuration.

**Step 1:** Check the capacity of the existing footing.

Calculate the weight of the structure and proposed brick veneer system on a square foot basis and compare it to the allowable bearing capacity for the specific site soils. If the bearing pressure from gravity loads is less than the allowable bearing pressure, the existing footing can withstand the increased loading. If the bearing pressure from gravity loads is greater than the allowable soil bearing pressure, the existing footing is unable to withstand the increased loading and the footing must be modified, or the designer should select another floodproofing measure.

**Step 1A:** Supplement the footing, as required.

If it is found that the existing footing cannot support the loads expected from a veneer system or that the configuration of the footing is unacceptable, the footing can be widened to accommodate this load. This can be a costly and detailed modification. The homeowner should be informed of the complexity and cost of such a measure. The following considerations should be followed during design of a footing supplement:

- a. If additional width is added to the footing, the designer must analyze how the footing will work as a unit. Reinforcing must be attached to both the old and new footing. This may involve drilling and epoxy grouting reinforcement into the existing footing. The quality and condition of the existing concrete and reinforcement should be considered in the design.
- b. Exercise care when making excavations beside existing footings. Take care not to undermine the footings, which could create major structural problems or failure.
- c. Design the footing for the eccentric load from the brick weight. Add any flood-related loads and consider all possible load combinations.
- d. For extreme soil conditions, consult a geotechnical engineer to determine soil type and potential response.

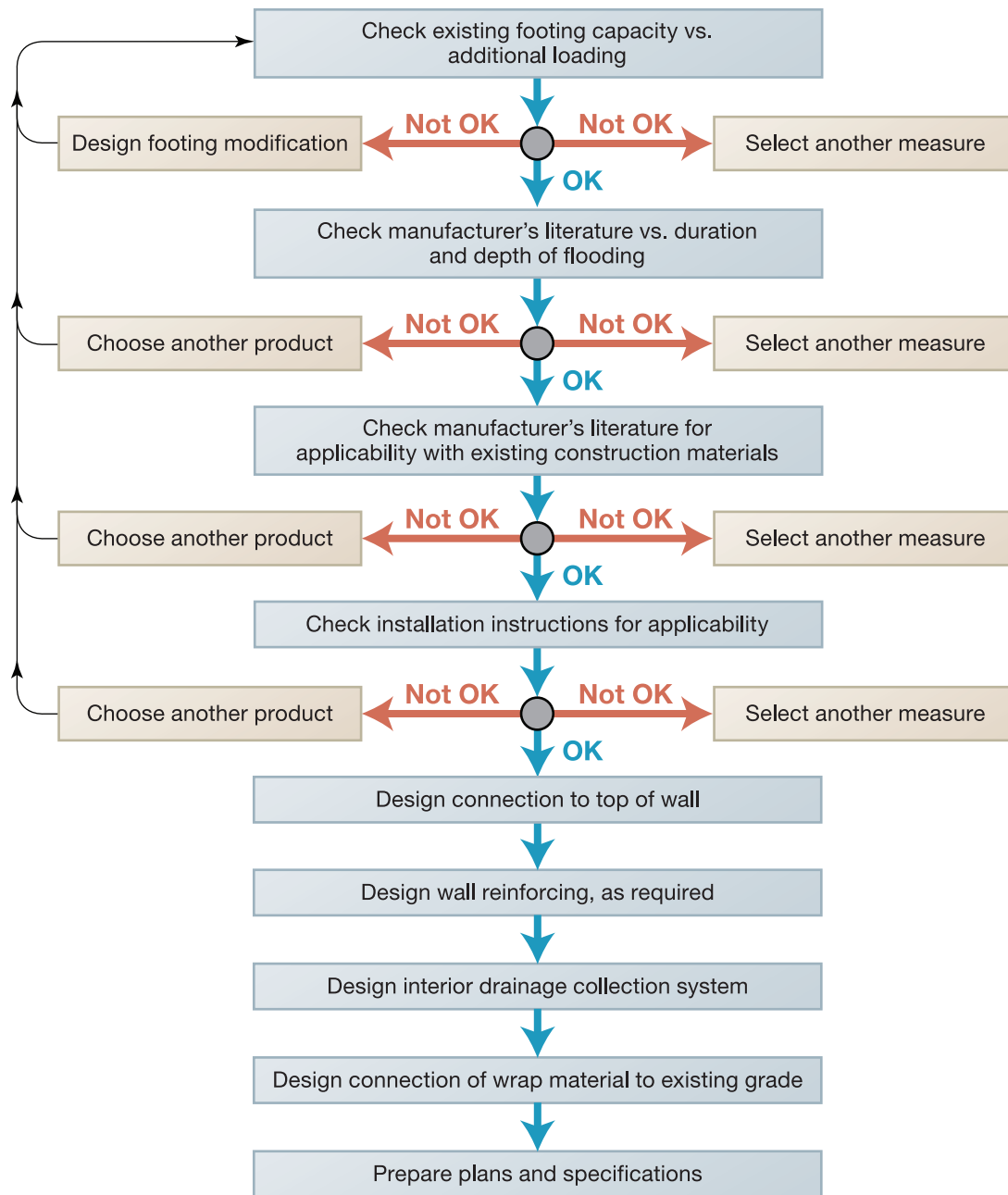

Figure 5D-20. Selection/design of a brick veneer sealant system

- e. The designer may want to refer to ACI 318, *Building Code Requirements for Structural Concrete and Commentary* (ACI, 2008ba), a soils manual/textbook for detailed footing design, and to applicable codes and standards.



**Step 1B: Design foundation reinforcing (as required).**

Concrete footings can come in a wide variety of configurations. Design of footings, especially those involved with retaining of materials, can become quite complex. There are many books that deal with the design of special foundations and, once the stresses are determined, the ACI 318, *Building Code Requirements for Structural Concrete and Commentary* (ACI, 2008ba), can provide guidelines for concrete reinforcement design.

**Steps 2–9** are similar to the design of wrapped sealant systems. Refer to the previous section for details on these steps.

Appendix C contains a design example that illustrates the process of analysis of a wood-framed wall system to resist flood and wind loads. Please note that ACI 530-08, *Building Code Requirements for Masonry Structures* (ACE, 2008b), does not allow veneers to be considered a structural load resisting system. The wall structural wall system must be capable of resisting the entire lateral loads applied. **This same process should be used for any dry floodproofing measure.**

## 5D.7 Selection and Design of Shield Systems

Once the determination is made that a foundation system can withstand the expected flood and flood-related forces, the selection of a shield system is relatively straightforward and centers on the ability of the selected material to structurally secure the opening, be compatible with the existing construction materials, and be responsive to the duration and depth of flooding expected.

### 5D.7.1 Plate Shields

The selection and design of a plate shield follows Figure 5D-21. If additional existing structural reinforcing is required, it should be performed in accordance with the guidance presented in the preceding section.

**Step 1:** Select the plate shield material.

Plate shield material selection may be driven by the size of the opening or the duration of flooding. For example, plywood shields would not hold up during long-term flooding.

- a. Consider flood duration and select steel or aluminum materials for long duration flooding and consider marine grade plywood materials for short duration flooding.
- b. Consider opening size and select steel and aluminum materials with stiffeners for larger openings and shored plywood with appropriate bracing for small openings.
- c. Installation of all shields should be quick and easy. Lighter materials such as plywood and aluminum are suitable for most homeowner installation.



#### NOTE

Industry has developed manufactured closure systems that may be applicable to specific situations. For additional information on the companies that manufacture these products, contact your local floodplain management or engineering office.

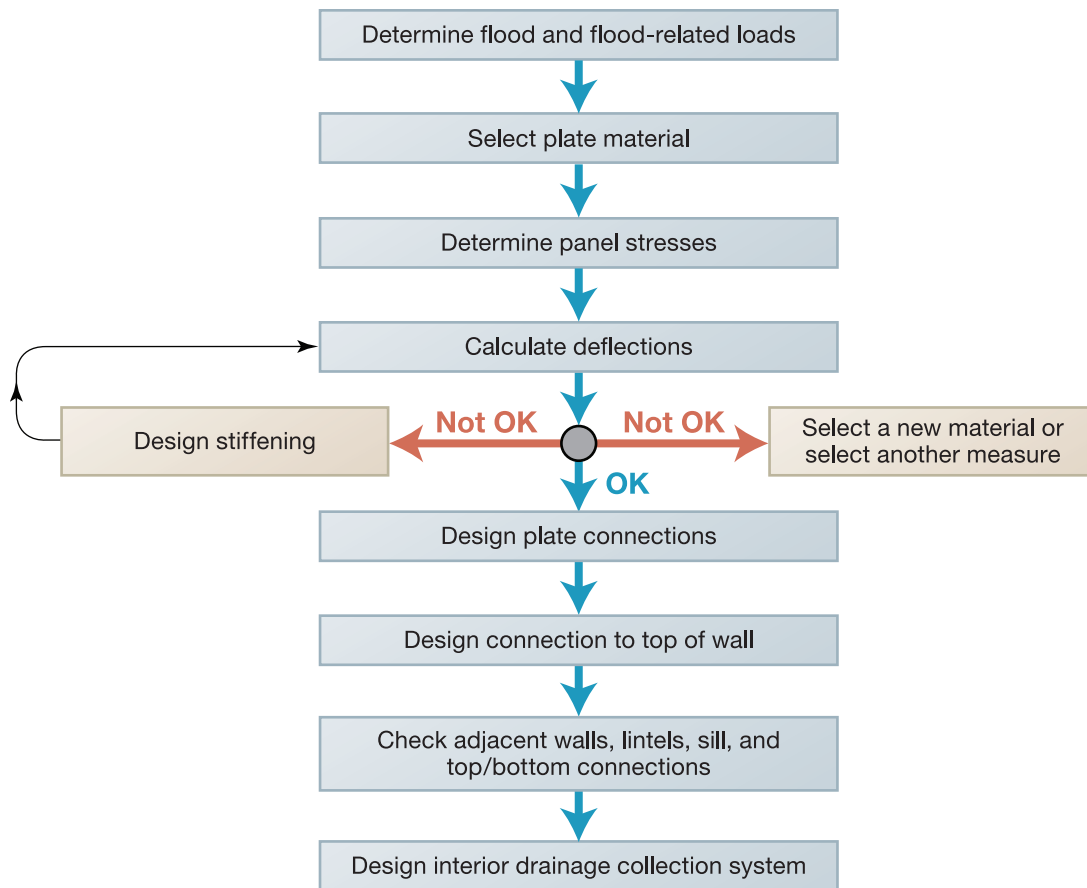

Figure 5D-21. Selection/design of plate shields

**Step 2:** Determine panel stresses.

The designer should check the shield panel either as a plate or a horizontal/vertical span across the opening.

- a. Using end conditions and attachments to determine how the panel will work, calculate stresses based on bending of the plate. In larger plate applications, also compute the end shear.
- b. Compare these stresses to the allowable stresses from the appropriate source.
- c. Some shields may have a free end at the top or other unusual configuration. These will need to be addressed on a case-by-case basis.
- d. Adjust the plate thickness to select the most economical section. If the plate does not work for larger thicknesses, add stiffeners.
- e. The designer may want to refer to the AISC 325, *Steel Construction Manual* (AISC, 2005) for steel plate design, an aluminum design manual, Aluminum Association (AA), *Aluminum Construction Manual*



**NOTE**

The use of plywood shields in long-term exposure situations may induce possible swelling and deterioration of the laminating glue.

(AA, 1959), ANSI/AF&PA *National Design Specification for Wood Construction* (ANSI/AF&PA, 2005) for plywood design, and applicable codes and standards.

**Step 3A:** Check deflections.

A plate shield that is acceptable for stresses may not be acceptable for deflection.

- a. Calculate deflections for the panel and evaluate on the basis of connections and sealants.
- b. If the deflection is unacceptable, add stiffeners.
- c. Deflection may be controlled by alternative plate materials.
- d. The designer may want to refer to the AISC 325, *Steel Construction Manual* (AISC, 2005), the *Aluminum Construction Manual* (Aluminum Association [AA], 1959), the ANSI/AF&PA *National Design Specification for Wood Construction* (ANSI/AF&PA, 2005) for plywood design, and applicable codes and standards.

**Step 3B:** Stiffen as required.

Plate overstress or deflection may be solved through the use of stiffeners.

- a. Select the section to be used as a stiffener. Angles may be used for steel or aluminum and wood stock for plywood.
- b. Calculate the stresses and deflection based on the composite section of stiffener and plate.
- c. Calculate the horizontal shear between the two sections and design the connections to carry this load.
- d. Keep plate connections and frame in mind when detailing stiffeners.
- e. The designer may want to refer to the AISC 325, *Steel Construction Manual* (AISC, 2005), the *Aluminum Construction Manual* (Aluminum Association [AA], 1959), the ANSI/AF&PA *National Design Specification for Wood Construction* (ANSI/AF&PA, 2005) for plywood design, mechanics of materials tests, and applicable codes and standards.

**Step 4A:** Design the connections.

Plate connections must be easy to install and able to handle the loads from the plate into the frame and surrounding wall.

- a. Determine the type of connection (hinged, free top, bolted, latching dogs, etc.).
- b. Consider ease of installation and aesthetics.
- c. Connection must operate in conjunction with gasket or sealant to prevent leakage.
- d. Connection must be capable of resisting some forces in the direction opposite of surges.
- e. The designer may want to refer to the AISC 325, *Steel Construction Manual* (AISC, 2005), for bolted connections; ACI 530, *Building Code Requirements for Masonry Structures* (ACI, 2008b), for connections into concrete and masonry, and applicable codes and standards.

**Step 4B:** Select the gasket or waterproofing.

Gaskets or waterproofing materials, which form the interface between shields and the existing structure, are vital elements of the dry floodproofing system. They should be flexible, durable, and applicable to the specific situation.

- a. Determine the type of gasket or waterproofing required.
- b. Consider ease of installation and ability to work with plate/connections as a single unit.
- c. Gasket/waterproofing must be able to withstand expected forces.
- d. Gasket/waterproofing must be able to function during climatic extremes.
- e. The designer should refer to manufacturer's literature and check against duration/depth of flooding and applicability to selected building materials.

**Step 6:** Check adjacent walls, lintels, sills, and top/bottom connections.

Structural components adjacent to the shield panel, such as adjacent walls, lintels, sills, and top/bottom connections, should be checked against maximum loading conditions. Different methods of attachment may load the adjacent wall differently.

Walls adjacent to the shield should be anchored into the footing to resist base shear. Lintels/sills should be checked for biaxial bending resulting from lateral loading. Top connections should be evaluated for shear resistance and ability to transfer loads to the joists.

## 5D.8 Construction Considerations for Sealants and Shields

The use of sealants and shields may require careful attention to critical installation activities. When using shields and sealants, it is vital that:

- the sealant be applied in accordance with the manufacturer's instructions;
- wrapped systems are anchored properly and the surrounding soil recompact;
- shields are tightly installed with associated caulking or gaskets, utilizing the proper grade of materials and paying close attention to the anchoring details; and
- multiple closures are accurately labeled and stored in an easily accessible space.

## 5D.9 Drainage Collection Systems

The expected reductions in hydrostatic loading imposed on the building from floodwaters depend on many factors. Drainage systems are typically designed to eliminate excess hydrostatic loads from storm runoff or high water tables and not high floodwaters. For short duration flooding at low levels, underdrain systems may reduce flood loads for dry floodproofing designs. These systems may also be utilized in concert with

elevation, floodwall, and levee measures. These systems collect drainage and seepage from areas along, adjacent to, or inside the retrofitting measure and the sump pump installation, which transmits the collected drainage and seepage away from the building's foundation. Determination of the amount of surface water inflow and infiltration was presented in Chapter 4. This section presents the parameters that govern the design of these systems.



**NOTE**

Check building codes to see if any maximum height of unbalanced fill requirements apply for the given construction.

Typical homes with basements are constructed on concrete footings upon which concrete or CMU block foundation walls are constructed. In some instances, the foundation walls are parged, and covered with a waterproof coating and/or perforated pipe underdrains are installed to carry water away from the exterior foundation walls (see Figure 5D-22). The excavations are then backfilled and compacted.

Check building codes to see if any maximum heights of unbalanced fill requirements apply for the given construction. However, in practice, this fill material is not and often cannot be compacted to a density equal to that of the undisturbed soils around the house. Because of the density difference, the fill material is capable of conducting and holding more water than the soil around it and frequently provides a storage area for the soil water. As flood levels rise around the structure, the combined water and soil pressure in the areas

**Figure 5D-22.**  
Typical residential masonry block wall construction

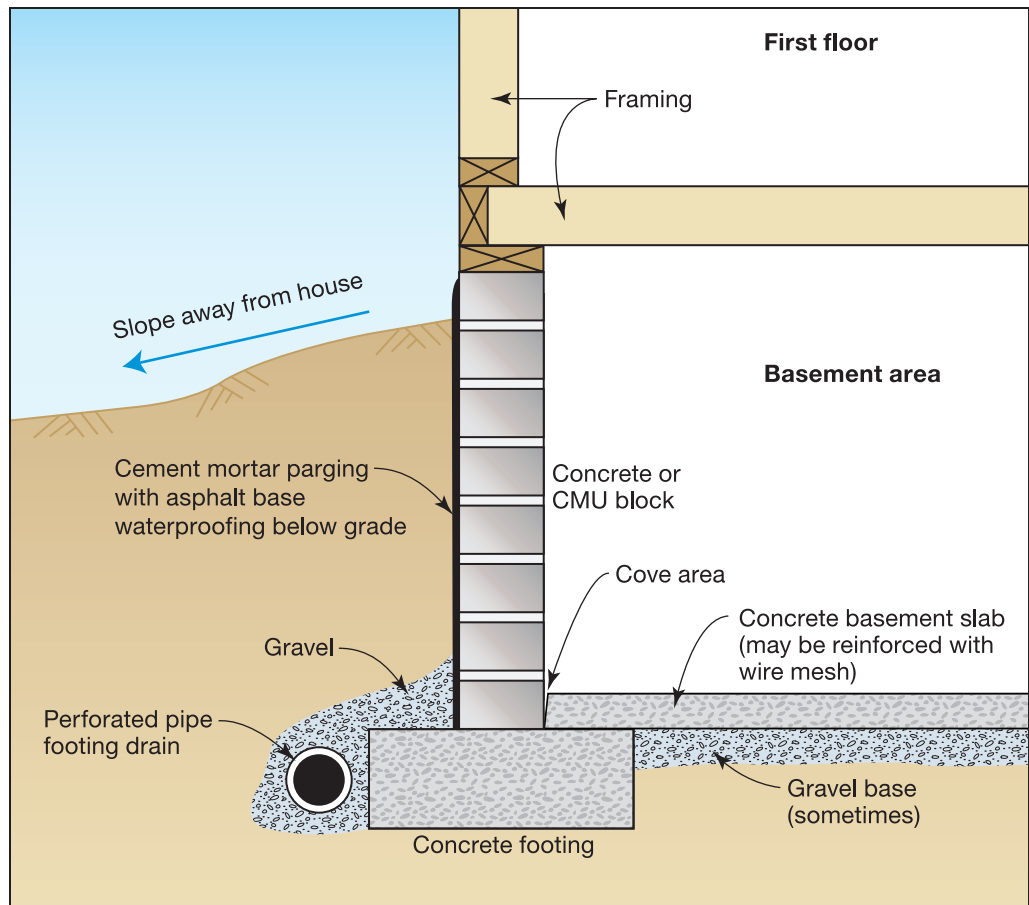

adjacent to the foundation increases to the point of cracking foundation walls and/or entering the basement through existing cracks to relieve the pressure (see Figure 5D-23).

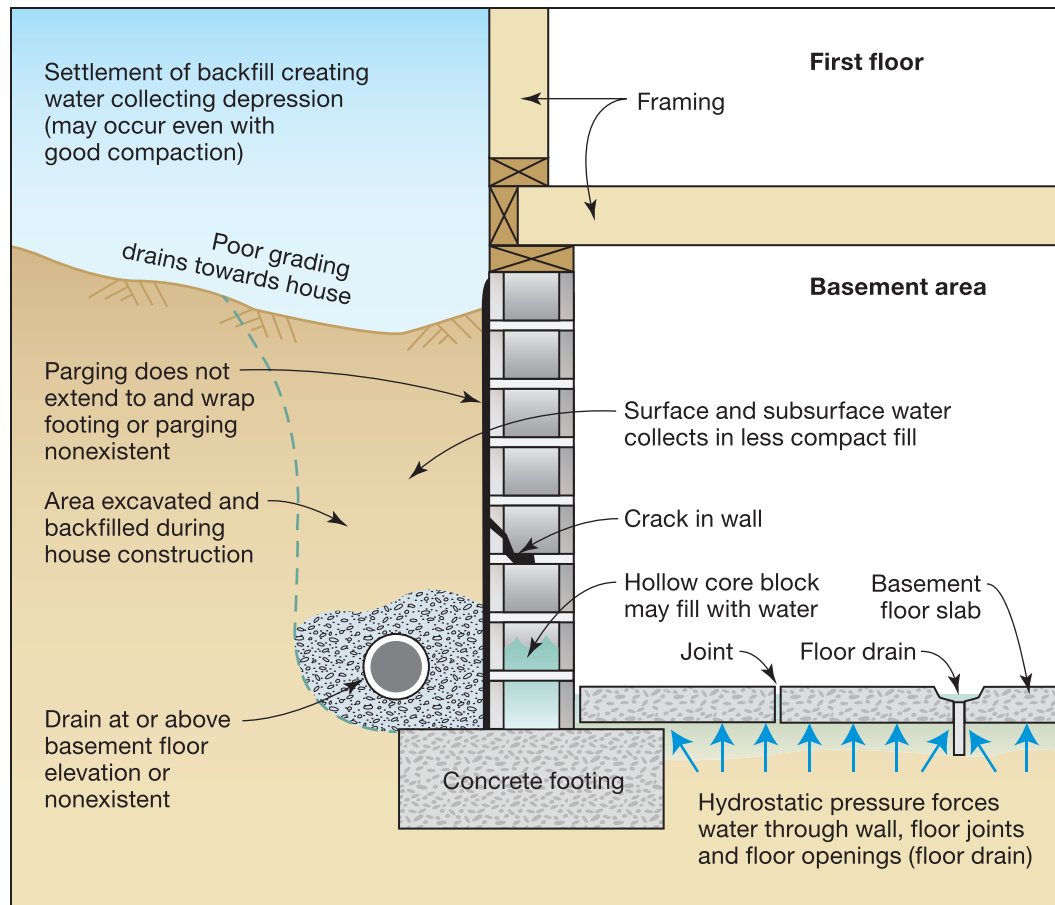

Figure 5D-23. Common faults contributing to seepage into basements

Depending upon site-specific soil conditions, high water tables, and local drainage characteristics, slab-on-grade houses may experience similar seepage problems. In addition, elevating and/or dry floodproofing a slab-on-grade house may also necessitate the installation of drainage collection systems to counteract buoyancy and lateral hydrostatic forces. Drainage collection systems consisting of perforated pipe drains are designed to collect this water and discharge it away from the structure, thereby relieving the pressure buildup against the foundation walls. Several types of drainage collection systems exist, including French drains, exterior underdrains, and interior drains. Poorly conceived drainage collection systems can result in water being drained into sumps at a rate that will exceed the capacity practical methods for removing the water (e.g., sump pumps). Although these systems typically drain storm runoff, excessive flood loads can overwhelm sump pumps and flood basements. Drainage systems may provide the most benefit to properties that are adjacent to floodplains where floodwaters may quickly elevate the water table a few feet above normal. In these situations, drainage systems may limit water seepage into basements or the lowest floors.



### 5D.9.1 French Drains

French drains are used to help dewater saturated soil adjacent to a foundation. They are simply trenches filled with gravel, filter fabric, and sometimes plastic pipe. A typical French drain section is shown in Figure 5D-24. The effectiveness of French drains is closely tied to the existence of a suitable discharge point and the slope/depth of the trench. A suitable discharge for the drain usually means an open stream, swale, ditch, or slope to which the drain can be run. If such a discharge point is not available, a French drain is generally not feasible.

If feasible, the French drain should be dug to a sufficient depth to ensure the capture of soil water that might infiltrate the fill material in the footing area of the basement. The slope of the trench should be such that good flow can be maintained between the gravel stones. This typically means a minimum slope of 1.0 percent or more.



#### NOTE

French drains are generally not suitable for areas subject to frequent inundation due to the lack of a gravity discharge point during a flood. However, they can be effective in keeping localized drainage away from the foundation (providing a significant flood doesn't occur). In some flood conditions, French drains can provide an easy way for floodwaters to inundate a foundation.

Figure 5D-24.  
Typical French drain system

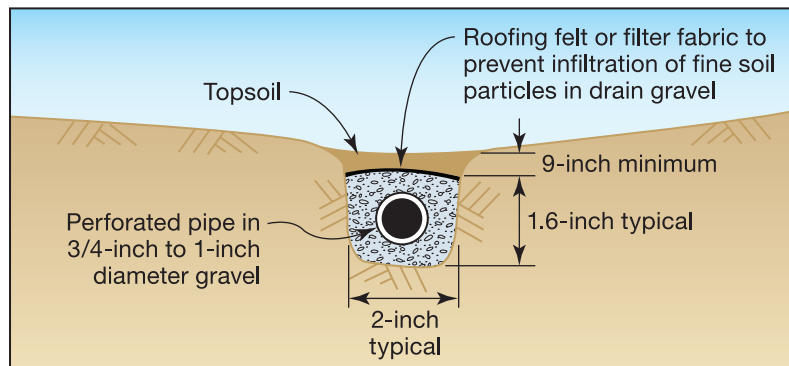

### 5D.9.2 Exterior Underdrain Systems

Exterior underdrain systems are generally the most reliable drainage collection system when combined with some type of foundation parging and waterproofing. Their chief advantage is that they will remove water that would otherwise exert pressure against the foundation walls and floors.

Underdrains are normally constructed of continuous perforated plastic pipe laid on a gravel filter bed, with drain holes facing up. The underdrains are placed along the building foundation just below the footing and carry water that collects to a gravity discharge or sump pump for disposal into a public drainage system, natural drainage course, or ground surface as permitted by local agencies (see Figures 5D-25 and 5D-26). These systems may not be sufficient when water tables or floodwaters exceed a few feet above the lowest floor (or basement).



#### NOTE

Similar to the French drain, an exterior underdrain system with gravity discharge will not work during a flood. Sump pump discharge with a backup energy source may provide some dewatering benefits in more frequent low-level flooding conditions, but may not be sufficient in high floodwaters.

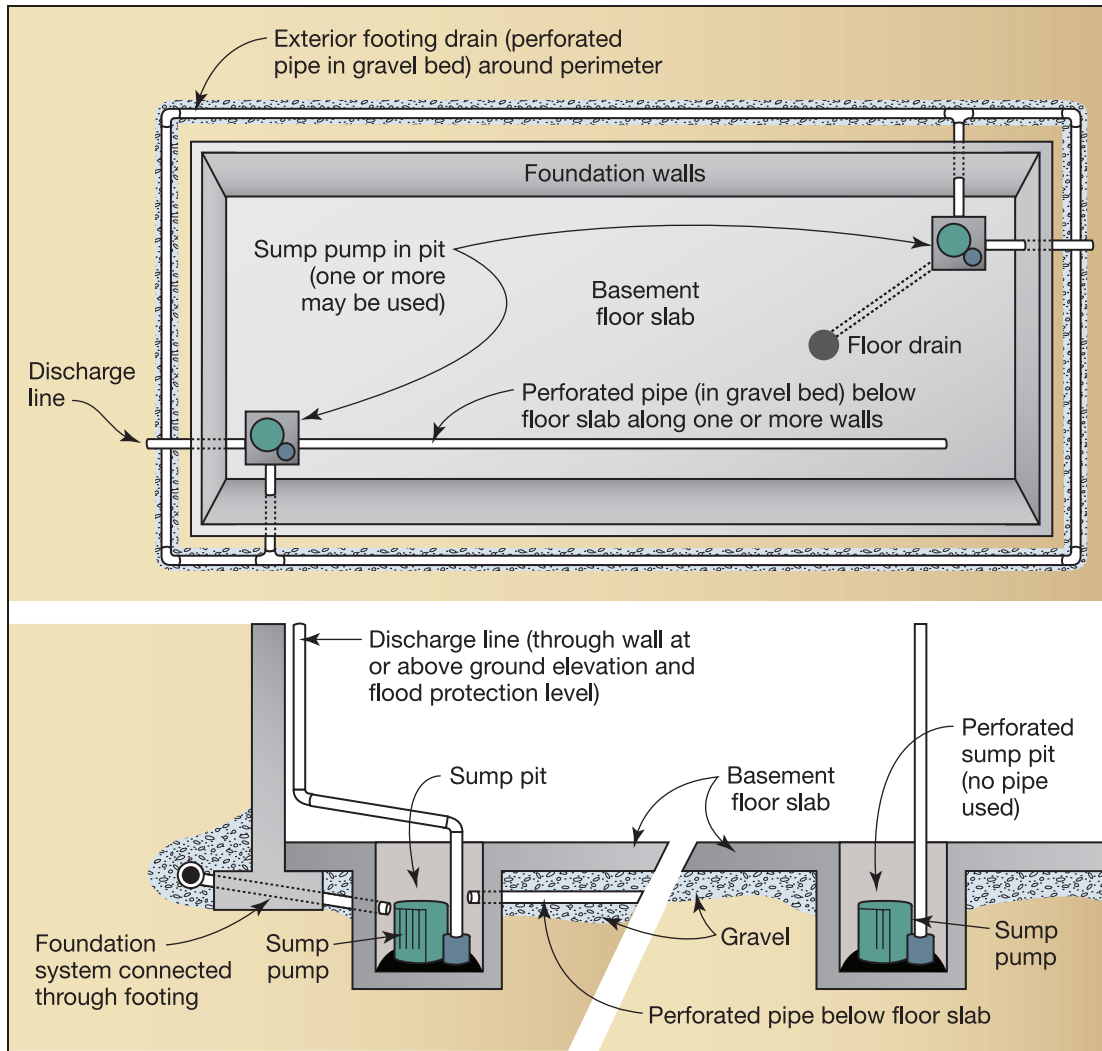

Figure 5D-25. Typical exterior underdrain system with sump pump showing two alternative configurations in the side view

### 5D.9.3 Interior Drain System

Interior drain systems are designed to relieve hydrostatic pressure from the exterior basement walls and floors and do not require that the soil be excavated from around the exterior basement walls for installation. Sump pumps are perhaps the most familiar of all methods used to dewater basements. The sump is generally constructed so that its bottom is well below the base of the basement floor slab. Water in the areas adjacent to the basement walls and floor migrate toward the area of least pressure along the lines of least resistance, in this case toward and into the sump. It may be necessary to provide a more readily accessible path of least resistance for water that has collected in the fill material and around the house to follow. To achieve this, pipe segments are inserted and sometimes drilled through the basement wall and into the fill behind. These pipe segments are then connected to larger diameter pipes running along a gravel-filled trench or cove area into the basement floor and into one or more sumps (see Figure 5D-27). These systems may be overwhelmed by quickly rising water tables.

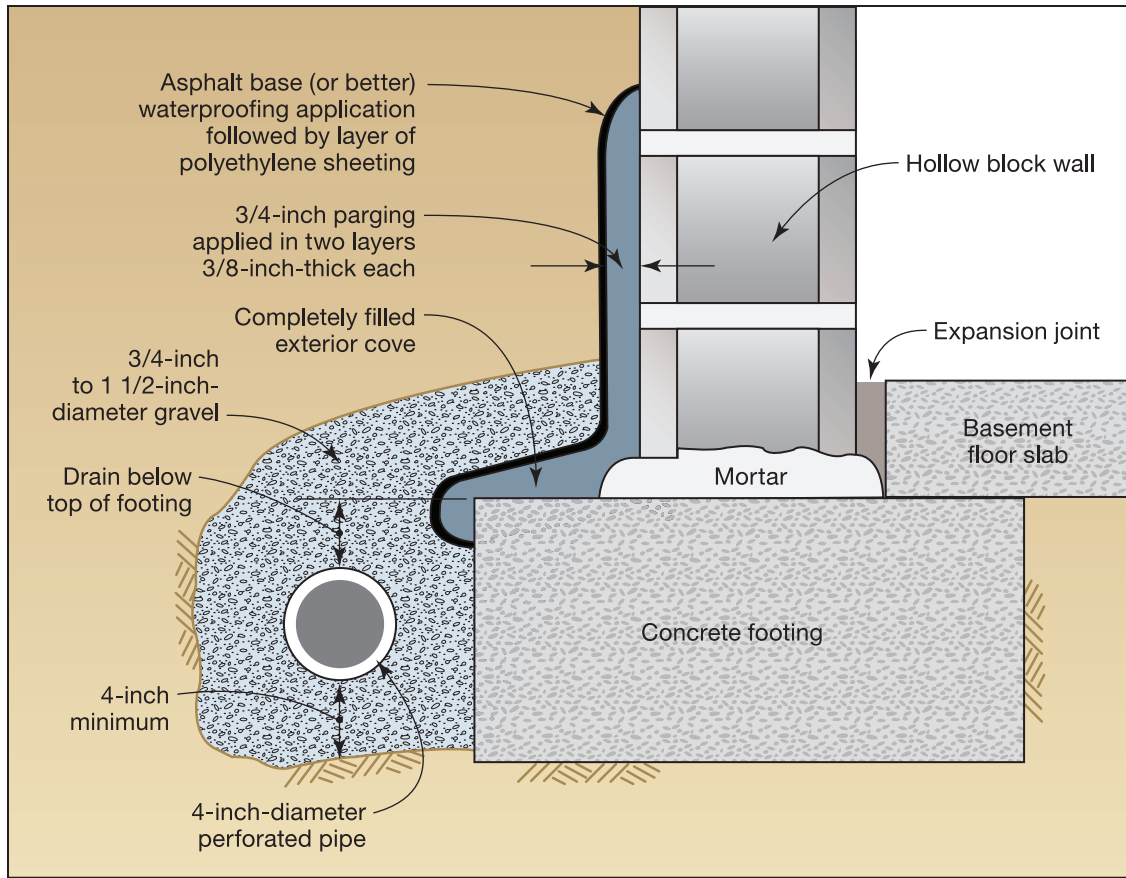

Figure 5D-26. Details of a combination underdrain and foundation waterproofing system

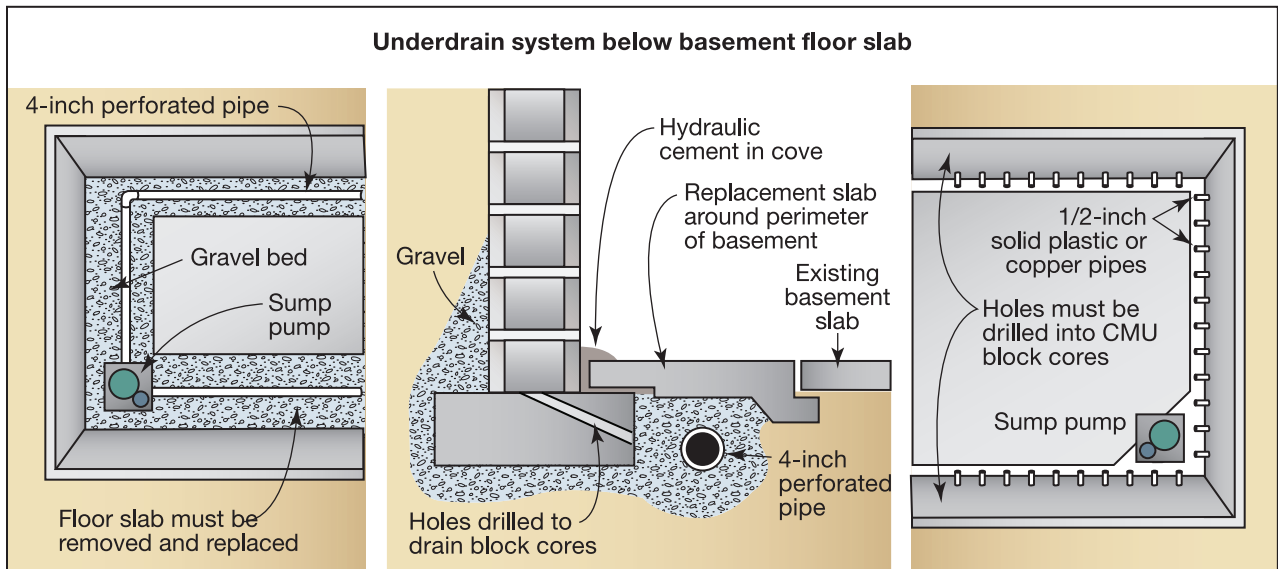

Figure 5D-27. Typical interior drain systems

### 5D.9.4 Types of Sump Pumps

Two types of sump pumps commonly used are the submersible and the pedestal. The submersible type has a watertight motor that is directly connected to the pump casing and installed at the bottom of the sump. The pedestal sump pump uses an open motor supported on a pipe column with the pump at its base. A long shaft inside the column connects the motor to the pump impeller. Figure 5D-28 depicts both of these pumps. Submersible pumps are preferred because they will continue to operate if the flood level exceeds the height of the pump.

In selecting a sump pump for use in residential floodproofing, the designer should consider the advantages of each pump type and make a selection based on requirements determined from investigation of the residence. Considerations include pump capacity (gpm or gallons per hour [gph]), pump head (vertical height that the water is lifted), and electrical power required (residential electrical power is usually 120/240 volts AC, single phase). Sump pump motors generally range in size from 1/4 horsepower to 1/2 horsepower designed to operate on either 120 or 240 volts.



**NOTE**

Battery powered marine-type bilge pumps are an alternative to sump pumps/electrical generator installations.

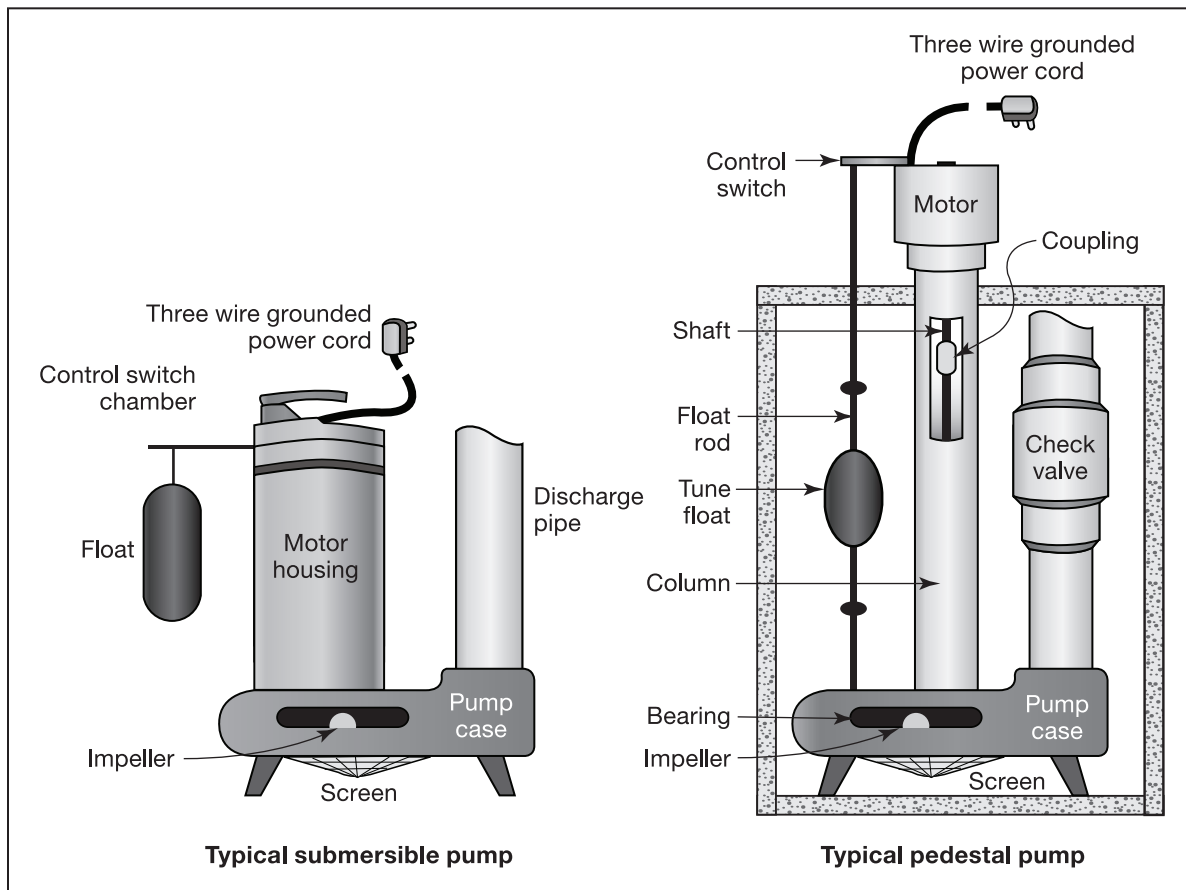

Figure 5D-28. Types of sump pumps

The type of float switch system to turn on the pump is also an important component. Many pumps use one of four types of switches. The diaphragm switch is activated by water pressure and is the most expensive type, but not necessarily the most reliable. A vertical action float switch has a float attached to a vertical rod, which activates the switch as it rises from the water level. This is inexpensive and relatively reliable. The tethered float switch works similar to the vertical action, but is only tethered by a line instead of a vertical rod. This method is inexpensive, but can experience many problems. The final common option is an electronic float free switch, which uses a wire that senses contact with water. This switch system may also include an audible alarm and some more expensive units also include options for connecting a backup pump. While all of these are viable options for residential application, it is important to evaluate the benefits and understand the reliability of each system.

If a pump system is depended on for dry floodproofing, it is important to verify that the pump(s) are working properly. One of the most common failure modes with sump pumps is the malfunction of the switch from internal or external causes. It is important to be familiar with pump switches and the proper procedure for replacing the switch. Although this can be an inexpensive part, the malfunction of a switch can negate the effectiveness of other floodproofing measures. Other common issues are an improperly working float (tells the sump pump when to operate), this may be caused by an obstruction that needs to be cleared or debris attached to the float, which make it less buoyant. A blocked intake or impeller is another issue associated with the failure of sump pumps to operate properly. Prior to doing any maintenance on a sump pump, it is important to make sure it is unplugged or disconnected from its power source.

### **5D.9.5 Infiltration versus Inundation**

The capacities of sump pumps used in residential applications are limited. In floodproofing, sump pumps are used to prevent accumulations of water within the residence. In conjunction with other floodproofing methods, sump pumps may be used to protect areas around heating equipment, water heaters, or other appliances from floodwaters. Sump pumps are useful to protect against infiltration of floodwaters through cracks and small openings in frequent low floodwater situations. In the event that there are large openings or that the structure is totally inundated, the pumping capacity of sump pumps will likely be exceeded, but they are useful for controlled dewatering after floodwaters slowly recede (if submersible pumps are used).

Owners should be warned that, even if an area is intended to be dry if floodwaters exceed the wall and floor slab design elevation, attempting to pump out an area prior to floodwaters receding is unwise. It is common in these situations for basement walls to collapse and cause major structural issues (Figure 5D-29).





Figure 5D-29.  
Foundation wall failure  
due to pumping out  
basement while ground  
was still saturated with  
water

### 5D.9.6 Coordination with Other Floodproofing Methods

Design and installation of a sump pump should be coordinated with other floodproofing methods such as sealants and shields, protection of utility systems (furnaces, water heaters, etc.), and emergency power.

### 5D.9.7 Field Investigation

Detailed information about the existing structure must be obtained to make decisions and calculations concerning the feasibility of using a sump pump. Use Figures 5-2 and 5-3 as a guide to record information about the residence. Items that the designer may require are covered in the sump pump field investigation worksheet (see Figure 5D-30).



Owner Name: \_\_\_\_\_ Prepared By: \_\_\_\_\_

Address: \_\_\_\_\_ Date: \_\_\_\_\_

Property Location: \_\_\_\_\_

**Sump Pump Field Investigation Worksheet**

Document physical location and characteristics of electrical system on a sketch or plan of the structure.

Determine base flood elevation: \_\_\_\_\_

Check with local building official's office for version of National Electrical Code (NEC) National Fire Protection Association (NFPA) 70 and, local electrical code requirements:

\_\_\_\_\_

Check with local building official's office for established regulations concerning flooded electrical equipment:

\_\_\_\_\_

Check with the regulatory agencies to determine which State and local codes and regulations regarding the design and installation of plumbing systems may apply to the installation of a sump pump:

\_\_\_\_\_

Determine location and condition of any existing drainage collection systems, including sump pits and pumps.

Does residence have subterranean areas such as a basement? \_\_\_\_ Yes \_\_\_\_ No

Is there a sump pump installed presently? \_\_\_\_ Yes \_\_\_\_ No: If so: \_\_\_\_\_

\_\_\_\_\_

Record nameplate data from pump: capacity (\_\_\_\_\_gph or gpm @ \_\_\_\_\_ FT HEAD), motor horsepower, voltage, and manufacturer's name and model number. \_\_\_\_\_

Sketch plan of basement indicating location of sump, heating and cooling equipment, water heaters, and floor drains.

How high above floor is receptacle outlet serving cord and plug connected to sump pumps? \_\_\_\_\_

Once this data is collected, the designer should answer the questions below to develop a preliminary concept for the installation of a sump pump.

If there is no sump pump and one is needed, note potential location for a sump and tentative location for pump discharge piping on above sketch plan.

Is there an electrical outlet nearby? \_\_\_\_ Yes \_\_\_\_ No

Does electrical panel have capacity to accommodate additional Ground Fault Interrupter (GFI) circuit if necessary? \_\_\_\_ Yes \_\_\_\_ No

If other floodproofing measures are to be considered, such as placing a flood barrier around heating equipment or other appliances, is the existing sump pump in an appropriate location? \_\_\_\_ Yes \_\_\_\_ No

Does another sump and sump pump need to be provided? \_\_\_\_ Yes \_\_\_\_ No

Select emergency branch circuit routing from sump pump to emergency panel. Note on sketch or plan.

Is sump pump branch circuit located above flood protection elevation and is it a GFI circuit? \_\_\_\_ Yes \_\_\_\_ No

Locate sump pump disconnect or outlet location near sump pump location above Flood Protection Elevation (FPE).

Once these questions have been answered, the designer can confirm sump pump installation applicability through:

Verify constraints because of applicable codes and regulation. \_\_\_\_\_

\_\_\_\_\_

Sump pump needed? \_\_\_\_ Yes \_\_\_\_ No

Is sump pump required by code? \_\_\_\_ Yes \_\_\_\_ No

Code constraints known? \_\_\_\_ Yes \_\_\_\_ No

Proceed to design? \_\_\_\_ Yes \_\_\_\_ No

Confirm that wiring can be routed exposed in unfinished areas and concealed in finished areas. \_\_\_\_ Yes \_\_\_\_ No

Confirm that panel has enough power to support sump pump addition. \_\_\_\_ Yes \_\_\_\_ No

**Figure 5D-30. Sump Pump Field Investigation Worksheet**

### 5D.9.8 Design

The design of sump pump applications follows the procedure outlined in the flow chart in Figure 5D-31.

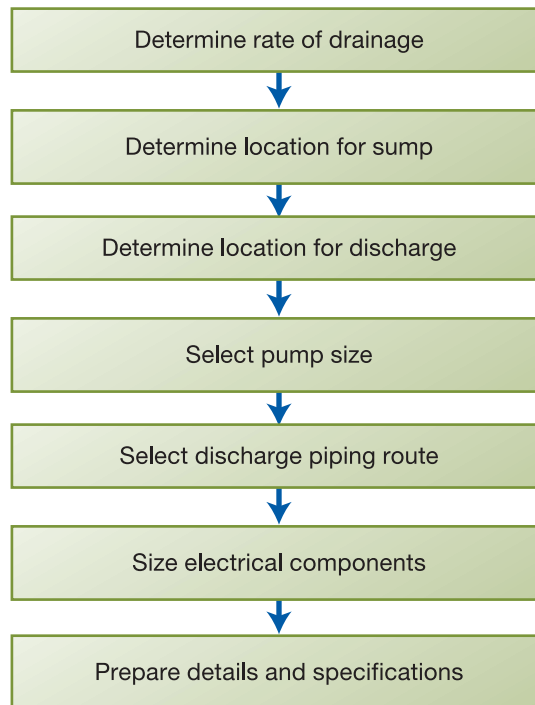

Figure 5D-31.  
Sump pump design  
process

**Step 1:** Determine rate of drainage.

This issue is covered previously in Chapter 4.

**Step 2:** Determine location for sump.

Refer to Figure 5D-32 for typical sump pump installation. Consider the following in locating the sump.

- Is there adequate room for the sump?
- Are there sub-floor conditions (i.e., structural footings) that would interfere with sump installation?
- If penetration of floor is not recommended, consider using a submersible pump design for use on any flat surface.
- Are other floodproofing measures being considered, such as placing a flood barrier around heating equipment or plumbing appliances? If so, locate sump or provide piping to sump to keep protected area dewatered. Make preliminary sketch showing location of sump pump, discharge piping, and location of electrical receptacle for pump.
- Coordinate sump location with design of drainage collection system.

Figure 5D-32.  
Typical sump detail

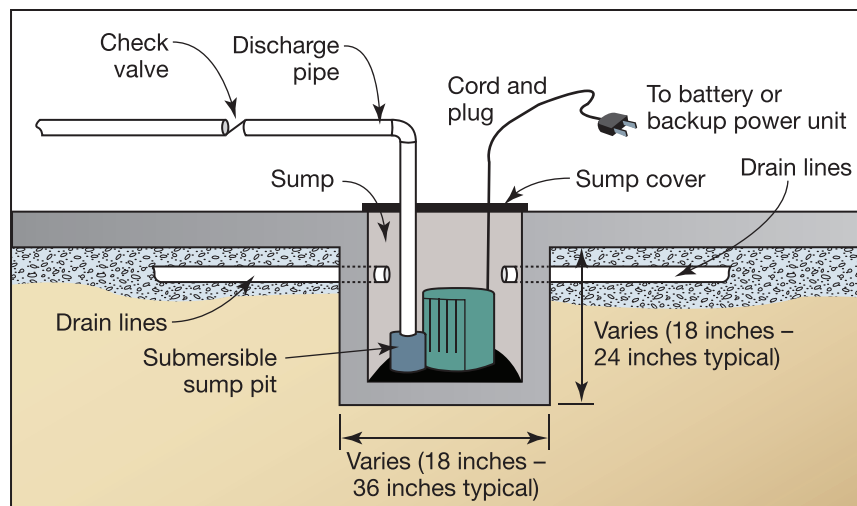

**Step 3:** Determine location for discharge.

Check with local authorities having jurisdiction about the discharge of clear water wastes. In most jurisdictions, it is not acceptable to connect to a sanitary drainage system, nor may it be desirable since, in a flood situation, it may back up. If allowable, the desirable location for the discharge is a point above the BFE at some distance away from the residence. The discharge point should be far enough away from the building that water does not infiltrate back into the building. From the information obtained during the field investigation, tentatively lay out the route of the discharge piping and locate the point of discharge.

**Step 4:** Select pump size.

Sump pumps for residential use generally have motors in the range of 1/6 to 3/4 horsepower and pumping capacities from 8 to 60 gpm. In selecting a pump, the designer needs the following information:

- Estimate of the quantity of floodwater that will infiltrate into the space per unit of time (gpm or gph).
- The total dynamic head for the sump discharge. This equals the vertical distance from the pump to the point of discharge plus the frictional resistance to flow through the piping, the fittings, and the transitions. Use the preliminary sketch and field investigation information developed earlier to determine these parameters. The total discharge head ( $TH$ ) is computed as shown in Equation 5D-1.
- The head loss due to pipe friction can be obtained from hydraulic engineering data books and is dependent on the pipe material and pipe length. The head losses due to pipe fittings and transitions are calculated as shown in Equation 5D-2.

The Sample Calculation for the size of a sump pump is available in Appendix C. This example illustrates the use of these equations to determine the total head requirements for a sump pump installation.



**NOTE**

Equation 5D-2 assumes steady pipe flow with no change in pipe size to maintain constant velocity.



**EQUATION 5D-1: TOTAL DISCHARGE HEAD**

$$TH = Z + h_{f-pipe} + h_{f-fittings} + h_{f-trans} \quad (\text{Eq. 5D-1})$$

where:

$TH$  = is the total head (ft)

$Z$  = elevation difference between the bottom of the sump and the point of discharge (ft)

$h_{f-pipe}$  = head loss due to pipe friction (ft)

$h_{f-fittings}$  = head loss through the fittings (ft)

$h_{f-trans}$  = head loss through the transitions (ft)



**EQUATION 5D-2: HEAD LOSSES DUE TO PIPE FITTINGS AND TRANSITIONS**

$$h_{f-fittings} + h_{f-trans} = (K_b + K_e + K_o)(V^2/2g) \quad (\text{Eq. 5D-2})$$

where:

$h_{f-fittings}$  = head loss through pipe fittings (ft)

$h_{f-trans}$  = head loss through the transitions (ft)

$K_b$  = loss coefficient of the pipe fitting(s), taken from hydraulic engineering data books

$K_e$  = loss coefficient of the pipe entrance, assumed to be 0.5

$K_o$  = loss coefficient of the pipe exit/outlet, assumed to be 1.0

$V$  = velocity of flow through the pipe, taken from hydraulic engineering data books (ft/sec)

$g$  = acceleration of gravity, 32.2 (ft/sec<sup>2</sup>)

**Step 5:** Select pump size.

The capacity and size of the sump depends on two factors:

- physical size of the sump pump; and
- recommendations of the sump pump manufacturer regarding pump cycling or other constraints.

The designer should take these considerations into account in locating the sump and configuring the sump pump discharge.

**Step 6:** Select discharge piping route:

- measure minimize length of pipe between sump and discharge point;
- avoid utility and structural components along route;
- attach discharge pipe to structure as required by code; and
- protect discharge point against erosion.

**Step 7:** Size electrical components:

- obtain horsepower and full load amperage rating for sump pump;
- select GFI circuit, as required by code;
- size minimum circuit ampacity and maximum fuse size;
- size maximum circuit breaker size; and
- obtain recommended fuse size or circuit breaker size from manufacturer and compare to above maximum and minimum NEC sizes.

At this point, the designer should prepare a floor plan sketch showing the location of the sump pump, routing of discharge line, location of discharge point, and preliminary specifications for the sump pump, sump, piping, and appurtenances, and confirm the preliminary design with the homeowner, covering the following items:

- verify that proposed location of sump pump is feasible;
- verify electrical availability for sump pump;
- verify existing conditions along proposed routing of discharge piping and at location of discharge pipe termination;
- confirm selection and size of sump pump;
- confirm size and location of sump; and
- confirm special considerations regarding existing conditions affecting design and installation of sump pump and sump.

**Step 8:** Create details and specifications and prepare final plans showing:

- floor plan with location of sump and backwater valves;
- routing of discharge pipe and location of termination;
- details, notes, and schedules;
- sump pump detail;

- wall, floor, and wall penetration details:
  - sump construction details;
  - installation notes;
  - equipment notes (or schedule); and
  - discharge pipe termination;
- prepare specifications (on drawing or as a specifications booklet):
  - pipe and fittings;
  - insulation;
  - hangers and supports;
  - valves (including backwater valves); and
  - sump pumps.

Coordinate plans with work of others on additional floodproofing measures that may be proposed at the same residence.

## 5D.10 Backflow Valves

Backflow valves can help prevent backflow through the sanitary sewer and/or drainage systems into the house. They should be considered for sanitary sewer drainage systems that have fixtures below the FPE. In some instances, combined sewers (sanitary and storm) present the greatest need for backflow valves because they can prevent both a health and flooding hazard. Backflow valves are not foolproof: their effectiveness can be reduced because of fouling of the internal mechanism by soil or debris. Periodic maintenance is required.

The backflow valve is similar to a check valve used in domestic water systems (see Figure 5D-33). It has an internal hinged plate that opens in the normal direction of flow. If flow is reversed (“backflow”), the hinged plate closes over the inlet to the valve. The valve generally has a cast-iron body with a removable cover for access and corrosion-resistant internal parts. The valves are available in nominal sizes from 2 to 8 inches in diameter.

As an added feature, some manufacturers include a shear gate mechanism that can be manually operated to close the drain line when backflow conditions exist. The valve would remain open during normal use. A second type of backflow valve is a ball float check valve (see Figure 5D-34) that can be installed on the bottom of outlet floor drains to prevent water from flowing up through the drain. This type of valve is often built into floor drains or traps in newer construction.



### NOTE

Depending upon the hydrostatic pressure in the sewer system, a simple wood plug can be used to close floor drains.

Advanced backflow valve systems have ejector pump attachments that are used to pump sewage around the backflow valve, forcing it into the sewer system during times of flooding. This system is useful in maintaining normal operation of sanitary and drainage system components during a flood. Figure 5D-33 presents the backflow valve design process.



Figure 5D-33.  
Backflow valve

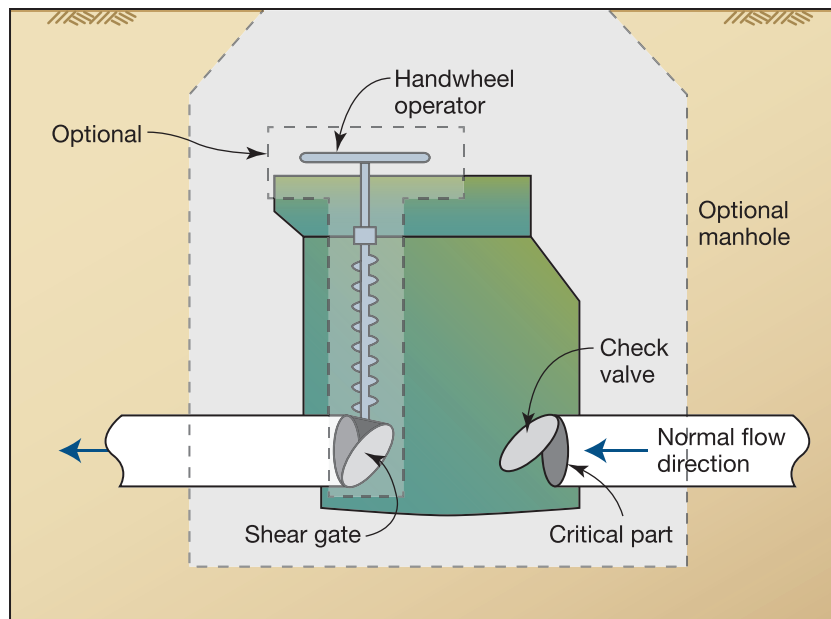

### 5D.10.1 Field Investigation

Detailed information must be obtained about the existing structure to make decisions and calculations concerning the feasibility of using a backflow valve. Figure 5D-34 shows the backflow valve selection process. Use Figure 5D-35 as a guide to record information about the residence. Once this data is collected, the designer should answer the questions below to develop a preliminary concept for the installation of a backflow valve.



#### NOTE

Alternatives to backflow valves include overhead sewers and standpipes. Their use should be carefully evaluated.

Figure 5D-34.  
Backflow valve selection

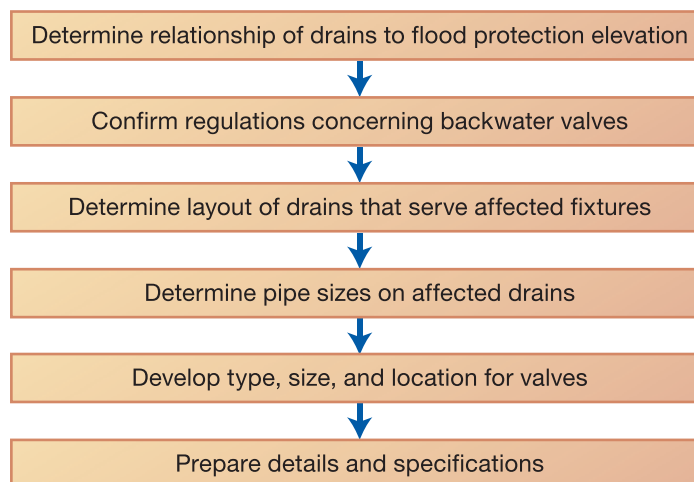

### 5D.10.2 Design

The designer should follow the process illustrated in Figure 5D-34.

Owner Name: _____ Prepared By: _____ Address: _____ Date: _____ Property Location: _____
<p><b>Backflow Valve Field Investigation Worksheet</b></p> <p>Does residence have plumbing fixtures or floor drains below flood protection elevation (FPE): ____ Yes ____ No</p> <p>Is building drainage system equipped with backflow valves, or do floor drains have backflow device? ____ Yes ____ No:</p> <p>If so, locate on a floor plan sketch of the residence.</p> <p>If there are no backflow valves and they are needed, consider the following in selecting a location for their installation.</p> <p>Can adequate clearance be maintained to remove access cover and service valve? ____ Yes ____ No</p> <p>Are there any codes that regulate or restrict installation of such valves? ____ Yes ____ No</p> <p>If yes, explain: _____</p> <p>Tentatively locate on sketch box where backflow valves might be installed.</p> <p>Proceed To Design? ____ Yes ____ No</p>

**Figure 5D-35. Backflow Valve Field Investigation Worksheet**

The elements of this process include:

**Step 1:** Determine relationship of drains to FPE.

If any drain or pipe fixtures are located below the FPE, backflow valves should be installed. If all drains and fixtures are located above the FPE, backflow valves are not necessary.

**Step 2:** Confirm regulations concerning backflow valves.

Based upon information collected during the field investigation, confirm the regulations governing the installation of backflow valves.

**Step 3:** Determine layout of drains that serve the impacted fixtures.

Make a floor plan sketch showing location of all plumbing fixtures and appliances, floor drains, and drain piping below the FPE.

**Step 4:** Determine pipe sizes on impacted drains.

Obtain the size of drainage lines below the FPE from the field investigation.

**Step 5:** Determine type, size, and location for valves.

Determine type, size, and location of backflow valves required, paying considerable attention to any special conditions related to installation. Factors to be considered include:

- clearance for access and maintenance;
- cutting and patching of concrete floors; and
- indicating on the floor plan sketch the tentative location(s) of the backflow valve(s).

**NOTE**

If possible, backflow valves should be located outside a structure so as to minimize damage should the pressurized line fail.

At this point, the designer should confirm the preliminary design with the homeowner, discussing the following items:

- verify that proposed locations of backflow valves are feasible;
- verify existing conditions at location of proposed backflow valve installation;
- confirm the size and location of needed backflow valves; and
- confirm special considerations regarding existing conditions affecting design and installation of backflow valves.

**Step 6:** Prepare details and specifications.

The final plans and specifications should include the following items:

- floor plan with location of backflow valves;
- details, notes, and schedules:
  - backflow valve detail;
  - wall, floor, and wall penetration details;
  - installation notes; and
  - equipment notes (or schedule);
- specifications governing the installation of:
  - pipes and fittings;
  - insulation;
  - hangers and supports; and
  - valves.

Coordinate plans with work of others on additional floodproofing measures that may be proposed at the same residence.

## 5D.11 Emergency Power

Emergency power equipment can be applied to residential applications if the proper guidelines are observed. First, it is not feasible to apply emergency power equipment to the operation of a whole house with electric resistance heat, heat pumps, air conditioning equipment, electric water heater, electric cooking equipment, or sump pump(s). These large loads would require very expensive emergency power equipment that would have considerable operating costs. However, small, economical, residential portable generators or battery backup units can be successfully installed to operate selected, critical electrical devices or equipment from the limited power source.

A list of appliances or equipment that a homeowner might choose to operate is shown in Table 5D-1. It is important to note that all of the appliances would most likely not be operated at the same time.

**Table 5D-1. Essential Equipment/Appliances to Operate from Emergency Power Source**

Critical Items
<ul style="list-style-type: none"> <li>• Floodwater sump pump – typically 1/3 to 1/2 hp 120 volt single phase</li> <li>• Domestic sewage pump – typically 3/4 hp to 1 hp 120 volt single phase</li> </ul>
Non-Critical Items
<ul style="list-style-type: none"> <li>• Refrigerator – 350 watts to 615 watts</li> <li>• Freezer – 341 watts to 440 watts</li> <li>• Gas or oil furnace – 1/7 hp burner, 1/3 hp to 1/2 hp blower motor</li> <li>• Some lighting or a light circuit – limit to approximately 400 watts</li> <li>• A receptacle or a receptacle circuit – limit to approximately 600 watts</li> </ul>

hp = horsepower

Several sources of technical information are available to assist in the design of emergency residential generator set installations.

- Some manufacturers provide application manuals and sizing forms to select small gasoline-powered, natural or liquid petroleum gas, or battery sets.
- Other manufacturers even offer software to size the small generator/battery sets.
- Another good source is the supplier of the standby generator/battery set. They have additional application data for sizing the unit to suit the anticipated load.
- The manufacturer of the set will provide a wattage and volt-ampere rating for each size at a particular voltage rating.

Selection of a generator/battery set is a matter of matching the unit capacity to the anticipated maximum load. The chief complication in sizing the generator/battery set is the starting characteristics of the electric motors in the pumps and appliances to be served.

### 5D.11.1 Field Investigation

Detailed information must be obtained about the existing structure to make decisions and calculations concerning the feasibility of using an emergency generator or battery backup unit. Use the Figures 5-2 and

5-3 located in the beginning of Chapter 5) as a guide to record information about the residence. Among the activities the designer may pursue are:

- examine the routing and condition of the existing building electrical system, noting potential locations for emergency power components (above the FPE and away from combustible materials);
- determine utility or power company service entrance location and routing;
- determine utility constraint data;
- record these items and locations on an electrical site plan/combination floor plan sketches;
- confirm space for cable routing between main panel, emergency panel, transfer switch, and proposed generator/battery set;
- examine existing panel branch circuit breakers and select circuits to be relocated to emergency panel; and
- confirm utility regulations on emergency power equipment with local power company.

### 5D.11.2 Design

The design of emergency power provisions is a straightforward process that is illustrated in Figure 5D-36. The steps include:

**Figure 5D-36.**  
Emergency power design process

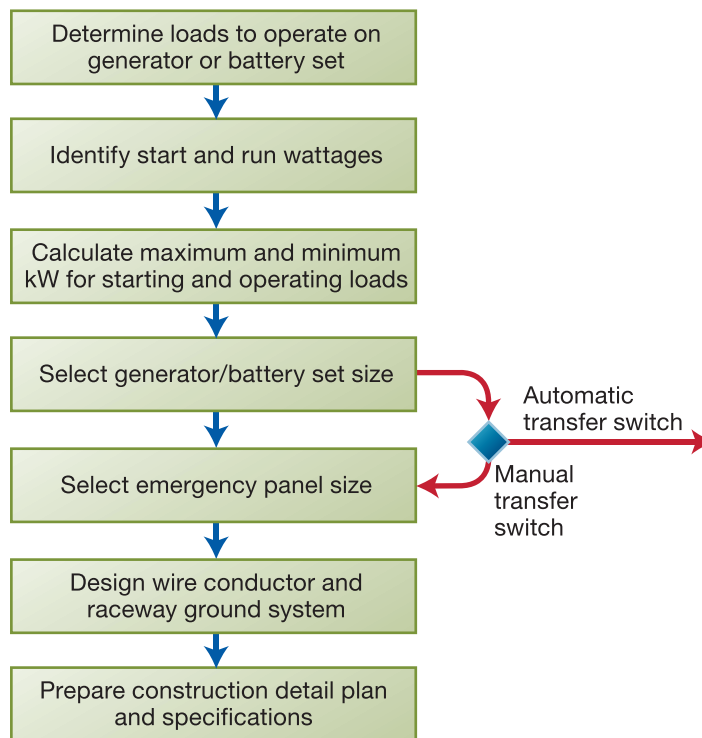

**Step 1:** Determine loads to operate on generator or battery set.

Table 5D-2 presents typical electrical appliance loads for some home equipment. The designer should work with the owner to select only those pumps/appliances that must be run by emergency power and confirm the estimated appliance and motor loads.

**Step 2:** Identify start and run wattages.

Start and run wattages for the appliance loads selected by the homeowner are shown in Table 5D-2.

**Step 3:** Calculate maximum and minimum kilowatts (kW) for operating loads.

Based upon the loads determined in Step 1, the designer should develop the range of minimum and maximum wattages for the desired applications. Table 5D-2 can be used to estimate these minimum and maximum loads.



**NOTE**

Since most power outages are temporary and relatively short lived, a battery backup source for sump pumps (only) may be the simplest solution for a homeowner. However, as the duration of the power outage increases, the suitability of battery backup systems decreases. Generator sets are a more secure source of power in these situations, especially for those residents who need/desire power to operate medical equipment or standard household appliances during power outages. Battery systems used in conjunction with emergency generators can provide service during a limited period if the owner is not home when the power goes out.

**Table 5D-2. Typical Electrical Appliance Loads**

Home Equipment	Typical Wattage	Start Wattage
<b>Critical Items</b>		
Limited lights (safety)	400	400
Sewage pump (3/4 hp to 1 hp)	1,000	4,000
Sump pump (1/3 hp to 1/2 hp)	333	2,300
Water pump	800–2,500	800–10,000
<b>Non-Critical Items</b>		
Refrigerator	400–800	1,600
Freezer	600–1,000	2,400
Furnace blower	400–600	1,600
Furnace oil burner	300	1,200
Furnace stoker	400	1,600
Limited receptacles	600	600

hp = horsepower

**Step 4:** Select generator/battery set size.

Size the generator/battery unit set from load information obtained in Step 1. Generator/battery unit set sizing is based upon the approximation that motor starting requirements are three to four times the nameplate wattage rating; thus, generator sets/battery units should be sized to handle four times the running watts of the expected appliance loads.



**NOTE**

Emergency power equipment should be located above the FPE.



Small generators/battery unit sets are usually rated in watts. Two ratings are often listed—a continuous rating for normal operation and a higher rating to allow for power surges. Match higher surge ratings with the starting wattage.

Generator sets can be loaded manually with individual loads coming on line in a particular sequence, or the loads can be transferred automatically with all devices trying to start at one time. This is illustrated in Tables 5D-3 and 5D-4.

**Table 5D-3. Example of Maximum Generator Sizing Procedure**

	Running Load (watts)	Starting Load (watts)
<b>Sewage pump</b>	1,000	4,000
<b>Furnace</b>	300 + 400 = 700	1,200 + 1,600 = 2,800
<b>Sump pump</b>	333	2,300
<b>Refrigerator</b>	400	1,600
<b>Freezer</b>	600	2,400
<b>Receptacles</b>	600	600
<b>Lights</b>	400	400
<b>Totals</b>	<b>4,033</b>	<b>14,100</b>

Even though many of the above appliances cycle on and off, common practice is to select a generator with a continuous rating that is at least as large as the total wattage to start all loads at once. The minimum size to start all motors at once appears to be 14 kW.

**Table 5D-4. Example Step Sequence Manual Start – Minimum Generator Sizing**

		Starting Load	+	Running Load (watts)
Sewage pump	<b>Step 1</b>	4,000	+	
Furnace	<b>Step 2</b>	2,800	+	1,000 = 3,800
Sump pump	<b>Step 3</b>	2,300	+	700 + 1,000 = 4,000
Refrigerator	<b>Step 4</b>	1,600	+	333 + 700 + 1,000 = 3,633
Freezer	<b>Step 5</b>	2,400	+	400 + 333 + 700 + 1,000 = 4,833
Receptacles	<b>Step 6</b>	600	+	600 + 400 + 333 + 700 + 1,000 = 3,633
Lights	<b>Step 7</b>	400	+	600 + 600 + 400 + 333 + 700 + 1,000 = 4,033

Largest load is 4,833 watts; thus a 5 kW generator set is minimum size.

For each step or appliance load, add the running wattage of items already operating to the starting wattage of the items being started in that step. Select the largest wattage value out of all steps. Compare maximum wattage with continuous wattage rating of the generator.

At this point, the designer has sufficient information to present preliminary equipment recommendations to the homeowner, prior to the design of transfer switches, emergency panels, wiring, and other miscellaneous items. Among the issues the designer should confirm with the homeowner are:

- the essential power loads proposed for the generator/battery set; discuss any other essential loads pertaining to life or property safety;

- generator/battery set siting and proposed location; this should be discussed in light of unit weight, portage, storage, and handling methods; and
- provisions for fuel storage and fuel storage safety.

The designer should also:

- educate the homeowner on battery operating time and/or generator operating time vs. fuel tank capacity;
- present initial generator/battery set cost and future operating costs;
- discuss requirements for having equipment located above the FPE; and
- discuss generator heat radiation and exhaust precautions to prevent carbon monoxide poisoning.

**Step 5:** Select transfer switch size.

Transfer switches are designed to transfer emergency loads from the main house system to the generator/battery system in the event of a power failure. After power has been restored, the transfer switch is used to transfer power from the generator/battery set to the house system. Transfer switches can be manual or automatic. It is important to check with local code officials regarding requirements for how transfer switches are set up.

**Manual transfer switches** generally have the following characteristics:

- double-pole, double-throw, nonfusible, safety switch, general duty with factory installed solid neutral, and ground bus. Double-pole, double-throw transfer switches are typically required to prevent accidentally feeding power back into the utility lines to workers servicing the line. This switch also protects the generator set from damage when the power is restored;
- transfer switches are available with National Electrical Manufacturers Association (NEMA) 1 enclosures for indoor mounting and NEMA 3R enclosures for outdoor locations;
- the voltage rating of transfer switches is typically 250 volts; and
- available sizes are 30 amp, 60 amp, 100 amp, and 200 amp.

The designer should consider the following items when selecting a manual transfer switch:

- coordinate amperage to match emergency panel rating, continuous current rating of branch circuits, genset over current protection, and panel branch feeder circuit breaker size;
- fusible manual transfer switches are required as service entrance equipment and are required if the panel circuit breaker size does not correspond to the emergency panel size and generator/battery set circuit breaker size;
- several manufacturer models are not load break rated and require load shedding before transfer operation; these switches must be used for isolation only—they do not have quick make-quick break operation;

- some transfer switches are “lock out” capable in the “off” position;
- switches should have door interlocks to prevent the door from opening with the handle in the “on” position and
- avoid locating the transfer switch at a meter or service entrance outdoor location. Switches are not service entrance rated unless they are fusible and, with this scenario the total house load is transferred to the genset. This method requires a much larger switch and cannot be taken out of service without de-energizing the entire dwelling.

**Automatic transfer switches** are much more expensive than manual transfer switches and require an electrical start option for the generator/battery set. These switches are usually not cost-effective for homeowner generator/battery set installations, but may in certain applications involving life safety issues, warrant the added expense.

Automatic transfer switches automatically start the generator/battery set upon loss of regular power and transfer the emergency load to the generator/battery source. After power has been restored for some time, the transfer switch automatically transfers back to normal power source. The generator set continues to run for some time unloaded until the set has cooled down and then it shuts off. The designer should contact the manufacturers for specific applications data for these automatic transfer switch devices.

**Step 6:** Select emergency panel size.

Equipment and appliances that need to be powered by a generator/battery set are typically wired in an emergency panel box. The design of the emergency panel box should be conducted with the following considerations in mind:

- select branch circuit loads for emergency operation;
- size branch circuit over current devices in emergency panel to protect equipment and conductor feeding equipment; appliance circuits and motor loads should be sized in accordance with NEC requirements;
- size panel bus based upon NEC requirements and on continuous rating at 125 percent calculated load for items that could operate over 3 hours;
- verify panel box size vs. number and size of circuit breakers; and
- see Tables 5D-5 and 5D-6 for minimum panel bus sizes and emergency panel specification criteria.

**Table 5D-5. Minimum Panel Bus Sizes**

Ampacity	Pole Spaces
30	2
70	2
100	8
125	12–24

**Table 5D-6. Emergency Panel Specification Criteria**

Load center type residential panel
Main lug
Indoor NEMA 1 enclosure above flood protection level with isolated neutral for sub panel application
Same short circuit current rating as main panel with ground bar kit
Pole spaces as required for appliance and motor circuit breakers

At this point, the designer should confirm several items with the homeowner including:

- emergency panel location above flood protection level;
- transfer switch location above flood protection level; and
- no load transfer switch operation.

**Step 7:** Design wire conductor and raceway ground system.

Select route for wiring between panel, transfer switch, and generator set and specific wiring materials in accordance with local electric codes or NEC.

**Operations and Maintenance Issues:** The following instructions should be provided to the homeowner with generator equipment.

For manual start generators, operating procedures include:

1. Turn off or disconnect all electrical equipment, including essential equipment in emergency panel.  
CAUTION: Make sure solid state appliances remain off while standby power is operating.
2. Connect generator to receptacle.
3. Place transfer switch in generator position.
4. Start generator and bring it up to proper speed (1,800 revolutions per minute [rpm] or 3,600 rpm). Check generator volt meter; it should read 115-125 volts; the frequency meter should read 60 hertz plus or minus three hertz.
5. Start the motors and equipment individually, letting the genset return to normal engine speed after each load has been applied. The load should be applied in the sequence used to determine the genset size and generally with the largest motor load applied first. If the generator cuts out, turn off all the electrical equipment and restart.
6. Check the volt meter frequently. If it falls below 200 volts for 240-volt equipment or 100 volts for 120-volt equipment, reduce the load by turning off some equipment.
7. When normal power has been restored, turn off all the electrical equipment slowly, one load at a time. Turn off all emergency loads, place transfer switch in normal load position, and turn electrical equipment back on.



**WARNING**

If problems occur, turn off existing panel circuit breaker feeding the transfer switch before investigating problems with faulty connections or wiring.

8. Turn off genset circuit breaker. However, allow genset to run approximately 5 minutes for cool-down. Then turn off generator engine. Return generator to storage location.

For manual start generators, maintenance procedures include:

1. Operate generator at about 50 percent load monthly or bimonthly to ensure reliability.
2. Check for fuel leaks.
3. Change engine oil per manufacturer's requirements.
4. Replace or use the fuel supply about every 30 to 45 days to prevent moisture condensation in the tank and fuel breakdown. Gasoline additives can keep gasoline-powered generator fuel from breaking down.
5. Keep tank full.
6. Replace air filter element per manufacturer's requirements.

### **5D.11.3 Construction**

All wiring shall be installed by licensed electricians to meet NEC requirements, local electrical regulations, and requirements of the local power company. Bond ground from generator emergency panel through transfer switch back to main service panel.

## **5D.12 Non-Residential Construction**

Dry floodproofing can also be used with varying degrees of success on non-residential engineered buildings. The general concepts for dry floodproofing are the same for any structure. The application of the concepts can vary as to the size and nature of the building and its use. Due to the more robust nature of the construction, the more thorough examination of load path, and more rigorous inspection cycle, non-residential engineered buildings are more likely to have success in managing the overloads that occur with flood conditions. Extreme caution is still required to avoid the unintended consequences of creating more damage than was thought to have been avoided by the flood. Structural failure issues must be examined closely.

Options available to non-residential engineered construction are:

- permanent closure of non-essential vulnerable openings;
- watertight core areas;
- enhanced flood shields; and
- pressure relief systems to balance protect against structural failure (similar to wet floodproofing).

### **5D.12.1 Permanent Closure of Openings**

For instance, an owner may be able to permanently close some vulnerable openings lower in the structure (window wells and coal chutes) on non-residential structures that are not required for safety egress; this

would not be an option with residential construction. The types of walls, doors, and openings used in non-residential construction (engineered construction) are more likely to be able to carry the flood loads than non-engineered construction. The systems tend to use more durable and stronger materials such as concrete or CMU walls and steel doors. See Figure 5D-37 for an example of an infilled opening.



**Figure 5D-37.**  
Permanent closure of  
an opening to prevent  
floodwaters from  
entering the building

### 5D.12.2 Watertight Core Areas

In some cases, there may not be a need or ability to dry floodproof the entire building footprint. This may be due to the building needs, the geometry and use, or simply out of the economics of dry floodproofing. In these cases, critical core components and areas can be made flood-resistant. Typical areas to be protected would be utilities such as electrical distribution and switching areas, emergency generators, emergency fuel supplies, and other mission critical components that cannot be moved or elevated. See Figure 5D-38 for an example of a watertight door.



Figure 5D-38.  
A watertight door used  
to protect mechanical  
rooms for a hospital  
subject to floodwaters



### 5D.12.3 Enhanced Flood Shields

Non-residential buildings are likely to have different opening configurations and sizes than residential structures. Because flood shields are the most commonly used floodproofing method, special attention to the differences is required. Walls intended to support the flood shields must be able to support the installation of shields and water pressure.

Loading docks have a much greater open span and may not be able to easily bridge by a simple plate due to magnified forces. In these cases, intermediate supports may be beneficial to carry the load to the opening perimeter. This will require the installation of temporary flood columns to support the floor and header. Note that reinforcement of the header will likely be necessary to handle the additional out of plane loads.

There are various types of deployable flood shields that can be used, each with differing degrees of cost and ease of use. Examples for some of these deployable flood shields are: lift out, counter balanced, hinged, etc. Some have deformable gaskets and others have inflatable gaskets. Figure 5D-39 shows flood shields that can be raised and lowered to provide protection.

### 5D.12.4 Moveable Floodwalls

Moveable floodwalls may be installed in situations where construction of conventional floodwalls or levees is not acceptable because of related impacts on accessibility, cost, or aesthetics. Numerous deployable floodwalls have been developed. Figure 5D-40 shows moveable floodwalls in storage and Figure 5D-41 shows the location in which these floodwalls would be deployed.



Figure 5D-39.  
Flood shields that can be raised and lowered to protect a hospital mechanical room from floodwaters



Figure 5D-40.  
Moveable floodwalls in storage that can be deployed by filling baffles with water

Figure 5D-41.  
The location to which  
the moveable floodwalls  
shown in Figure 5D-40  
would be deployed



### 5D.12.5 Pressure Relief Systems

Pressure relief systems are similar to wet floodproofing measures. They allow for some level of dry floodproofing and then release the hydrostatic pressure if water levels exceed a specific height. A pressure relief system can be an added degree of protection against structural failure of a new building, or for an existing structure that cannot be modified to reduce uplift pressures. It is generally desirable to install some type of pressure relief system in conjunction with other dry floodproofing measures.





# 5E Elevation

One of the most common of all retrofitting techniques is to raise an entire existing superstructure above the DFE. When properly done, the elevation of a house places the living area above all but the most severe floods.

The steps required for elevating a building are essentially the same in all cases. A cradle of steel beams is inserted under (or through) the structure; jacks are used to raise both the beams and structure to the desired height; a new, elevated foundation for the house is constructed; utility systems are extended and modified; and the structure is lowered back onto the new foundation and reconnected.

While the same basic elevation techniques are used in all situations, the final siting and appearance of the house will depend on the final elevation and type of foundation used. However, the actual elevation process is only a small part of the whole operation in terms of planning, time, and expense. The most critical steps involve the preparation of the house for elevation and the construction of a new, adequately designed, and elevated foundation. The elevation process becomes even more complex with added weight, height, or complex design or shape of the house. Brick or stucco veneers may require removal prior to elevation. Building additions may need to be elevated independently from the main structure.



## NOTE

FEMA strongly encourages that flood retrofits provide protection to the DFE (or BFE plus 1 foot, whichever is higher). However, in some situations, lower flood-protection levels may be appropriate. Homeowners and design professionals should meet with a local building official to discuss the selected retrofit measure and the elevation to which it will protect the home. The text and examples in this manual assume flood protection measures will be implemented to the DFE.

## 5E.1 Types of Residential Structures that Can Be Elevated

The elevation of houses over a crawlspace; houses with basements; houses on piers, columns, or piles; and houses on a slab-on-grade are examined here. In each of these situations, the designer must account for multiple (non-flood-related) hazards, such as wind and seismic forces. The various methods utilized to elevate different home types are illustrated in the pages that follow, providing the designer with an introduction to the design of these measures.

Houses that are elevated using solid foundation walls as opposed to piers, columns, or piles to raise the finished floor to or above the DFE must include openings to allow the automatic entry and exit of floodwater. Guidance on the design and installation of flood vents can be found in Section 5E.1.2.1.

### 5E.1.1 Houses Over a Crawlspace

These are generally the easiest and least expensive houses to elevate. They are usually one- or two-story houses built on a masonry crawlspace wall. This allows for access in placing the steel beams under the house for lifting. The added benefit is that, since most crawlspaces have low clearance, most utilities (heat pumps, water heaters, air conditioners, etc.) are not placed under the home; thus the need to relocate utilities may be limited. Houses over a crawlspace can be:

- elevated on extended solid foundation walls (see Figures 5E-1 through 5E-5); or
- elevated on an open foundation such as masonry piers (see Figures 5E-6 through 5E-8).



#### NOTE

Figures 5E-1 through 5E-5 illustrate the elevation of a home on extended solid foundation walls. Subsequent figures for various elevation techniques will include only those illustrations unique to that technique.



#### CROSS REFERENCE

Information on the design of foundation wall openings and adjustment of existing utility systems can be found in Chapter 5W.

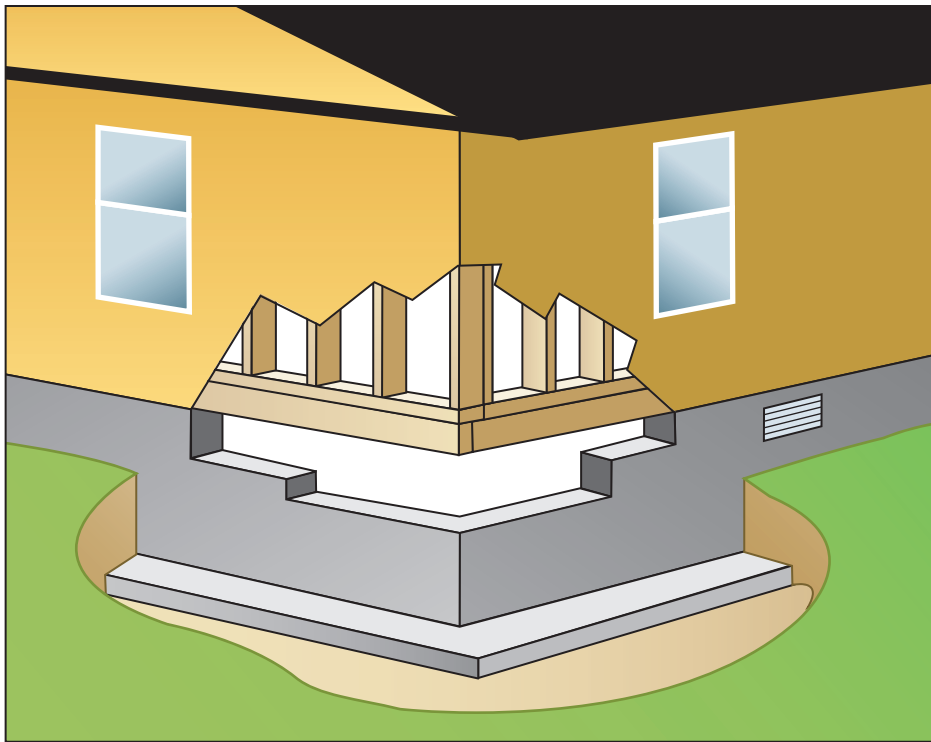

Figure 5E-1. Existing wood-frame house on crawlspace foundation to be elevated with extended walls and piers

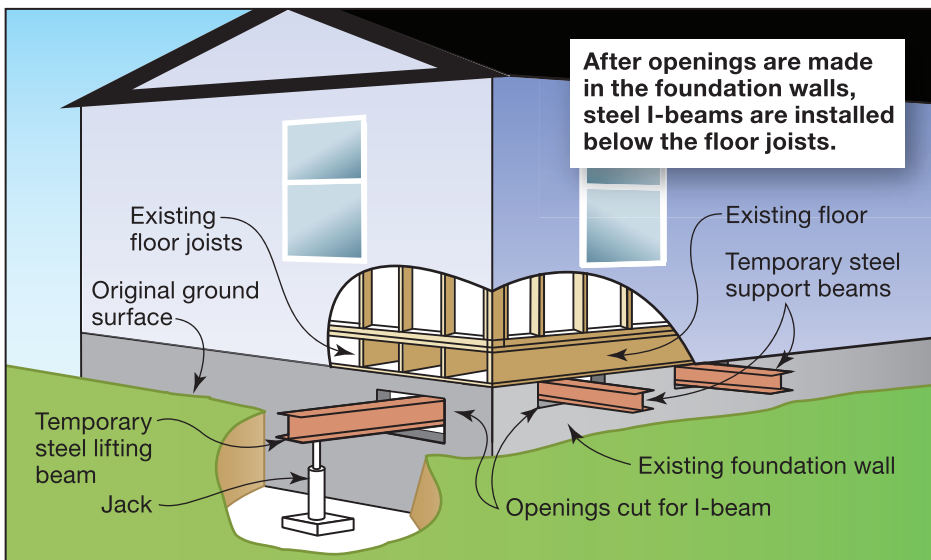

Figure 5E-2. Step 1 of elevating an existing wood-frame house on extended foundation walls and piers: Install network of steel I-beams



Figure 5E-3.  
Step 2 of elevating an existing wood-frame house on extended foundation walls and piers: Lift house and extend foundation walls and piers (reinforce as needed); relocate utility and mechanical equipment above flood level

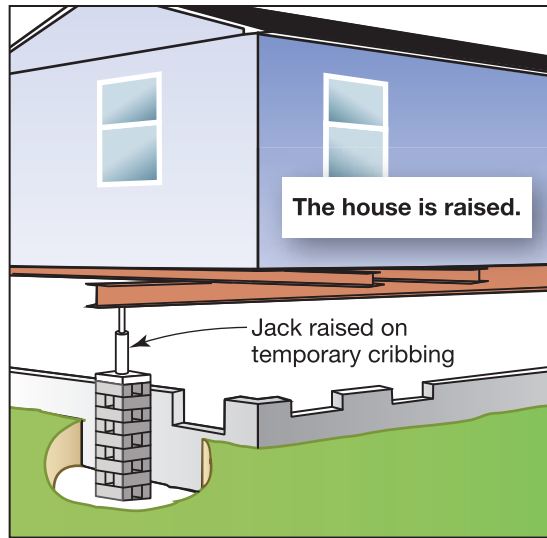
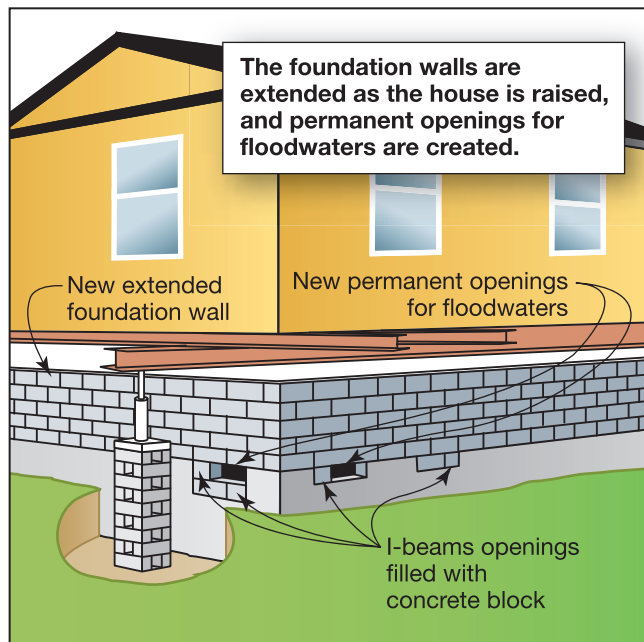

Figure 5E-4.  
Step 3 of elevating an existing wood-frame house on extended foundation walls and piers: Set house on new extended foundation and remove I-beams



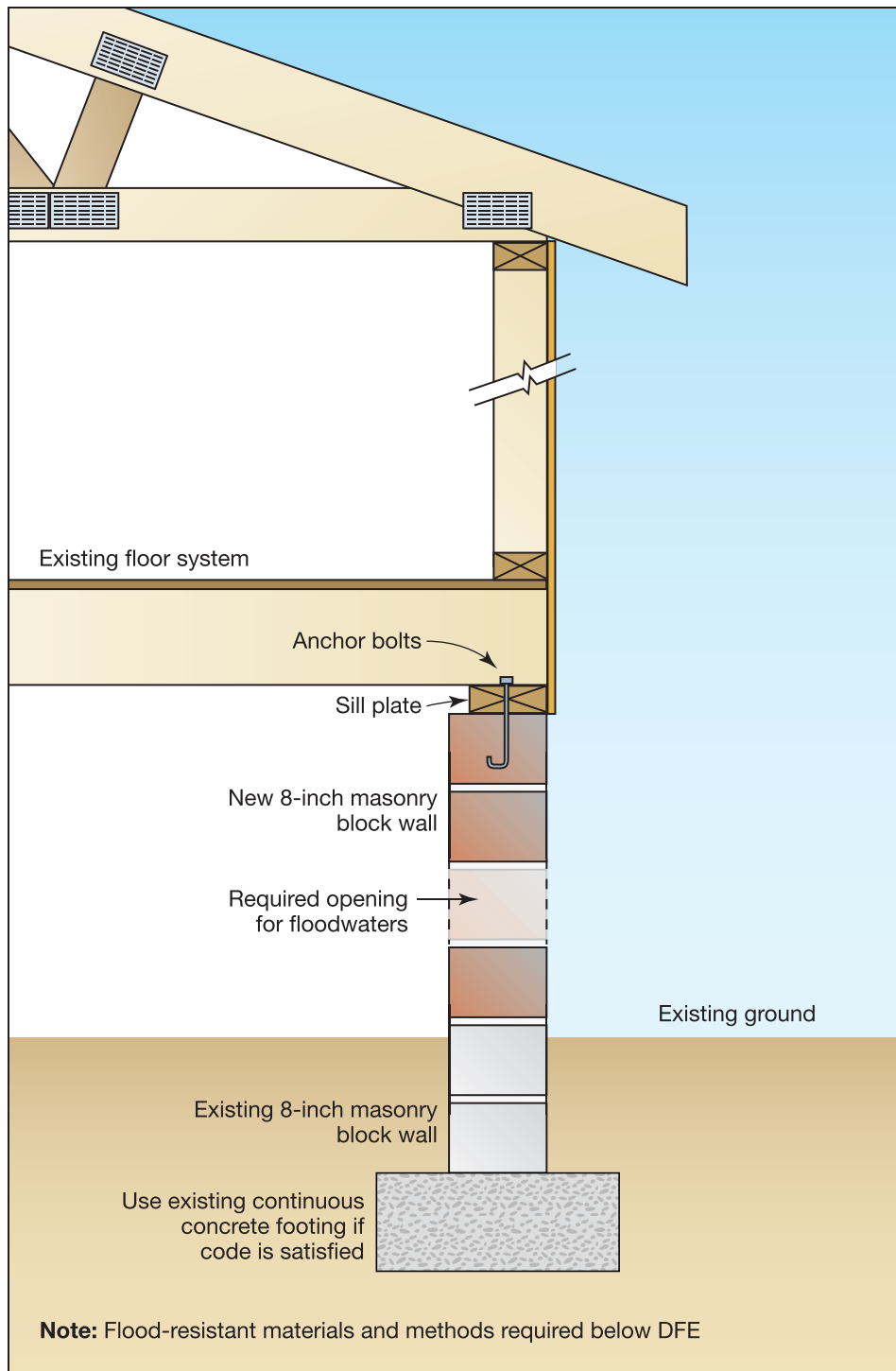

Figure 5E-5.  
Cross-section of elevated  
wood-frame house on  
extended piers and  
crawspace walls

Figure 5E-6.  
 Step 1 of elevating an existing wood frame house on new or extended pier foundations: Install network of steel I-beams. Step 2 (not shown): Lift house, rebuilding or extending (reinforce as needed) piers; relocate utility and mechanical equipment above flood level.

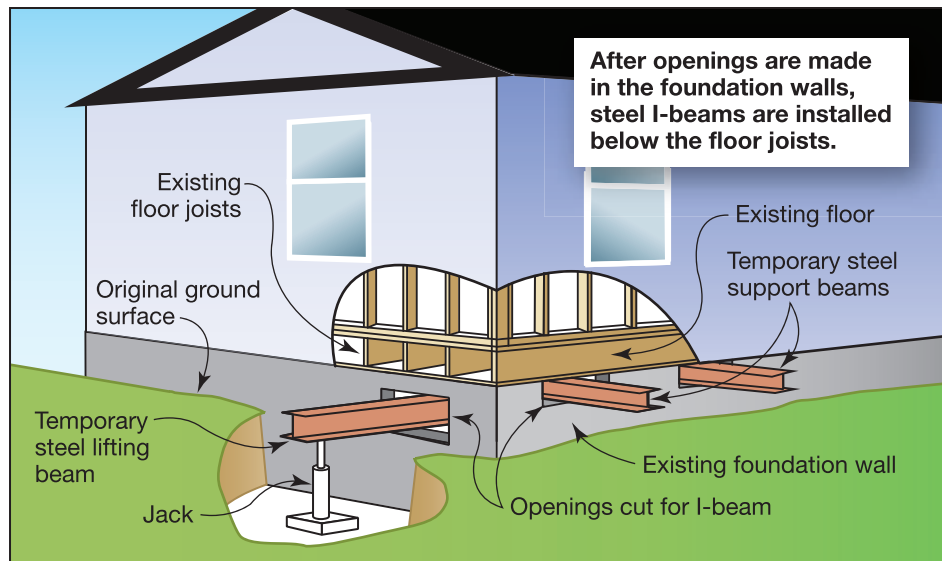
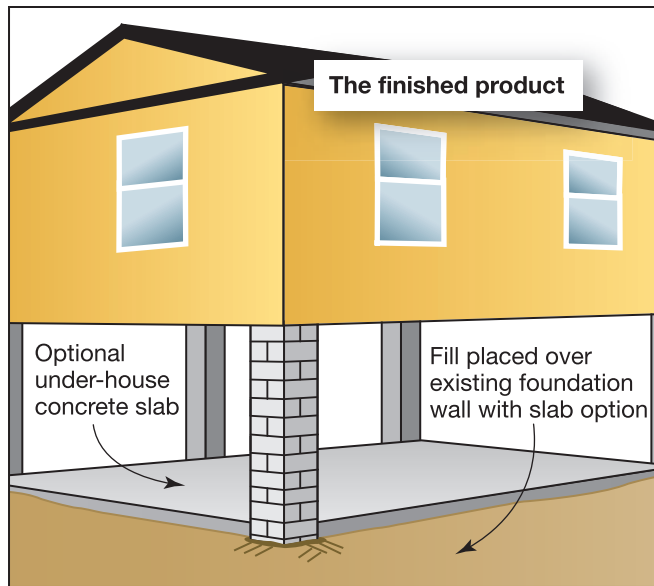

Figure 5E-7.  
 Step 3 of elevating an existing wood-frame house on new or extended pier foundation: Set house on new or extended piers



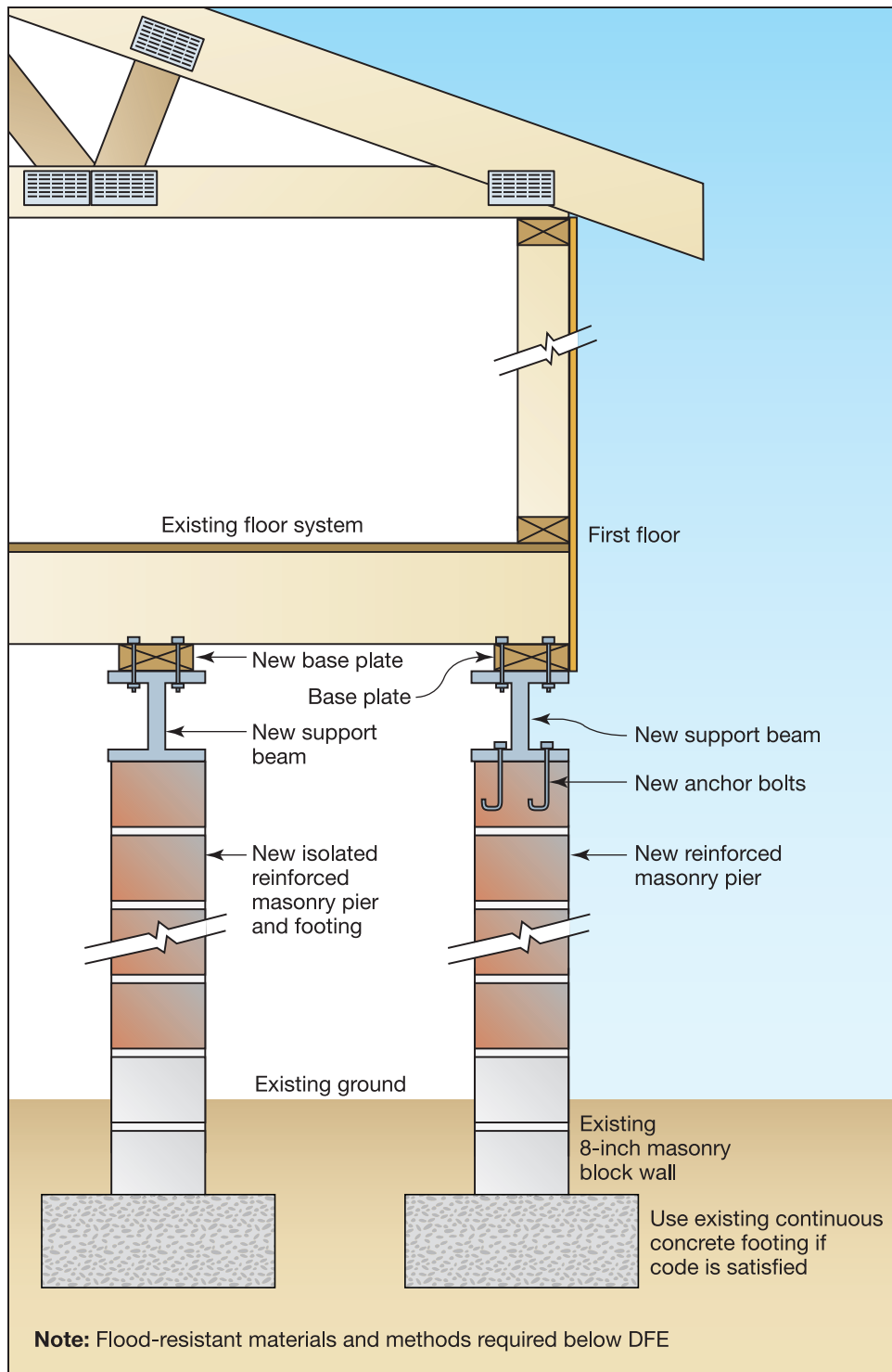

Figure 5E-8. Cross-section of elevated wood-frame house on new or extended pier foundation

### 5E.1.2 Houses Over Basements

These houses are slightly more difficult to elevate because their mechanical and HVAC equipment is usually in the basement. In addition, basement walls may already have been extended to the point where they cannot structurally withstand flood forces. Houses over basements can be:

- elevated on solid foundation walls by creating a new masonry-enclosed area on top of an abandoned and filled-in basement (see Figures 5E-9 and 5E-10); or
- elevated on an open foundation, such as masonry piers, by filling in the old basement (see Figures 5E-11 and 5E-12).



#### CROSS REFERENCE

FEMA's post- and pre-FIRM requirements do not allow basements below the BFE for substantially damaged/improved and post-FIRM applications. For more information on what retrofitting measures are allowable under FEMA guidelines, refer to Chapter 2, Regulatory Requirements.

Figure 5E-9. Elevated wood-frame house with new masonry-enclosed area on top of an abandoned and filled-in basement; utility and mechanical equipment must be relocated above the flood level

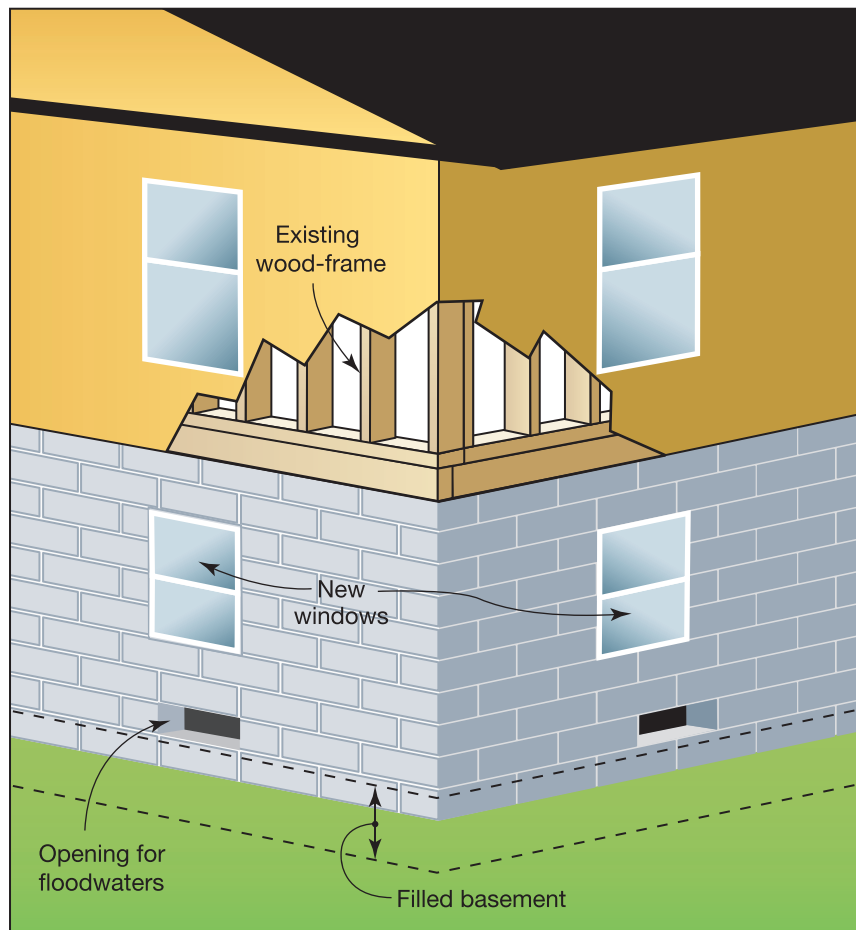

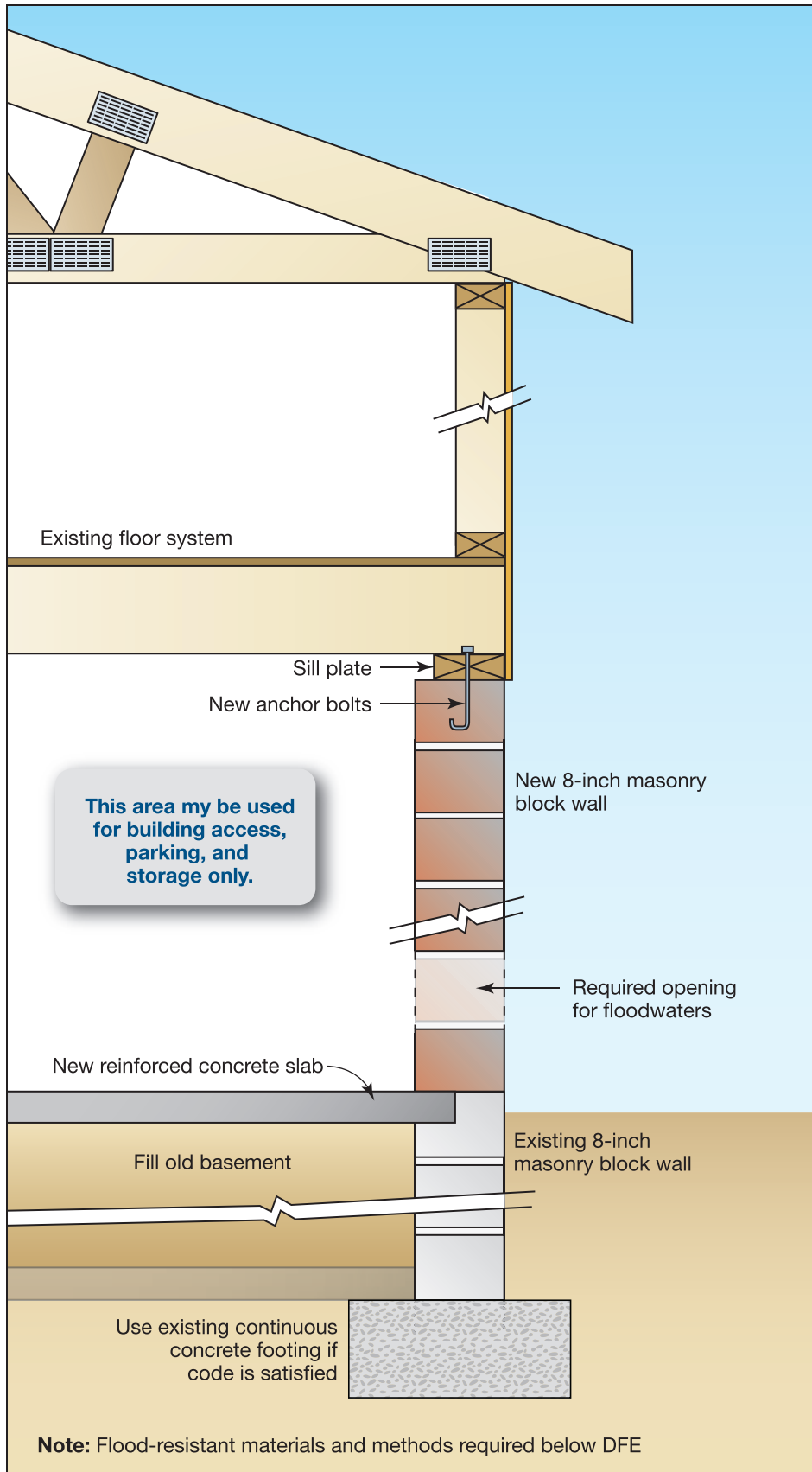
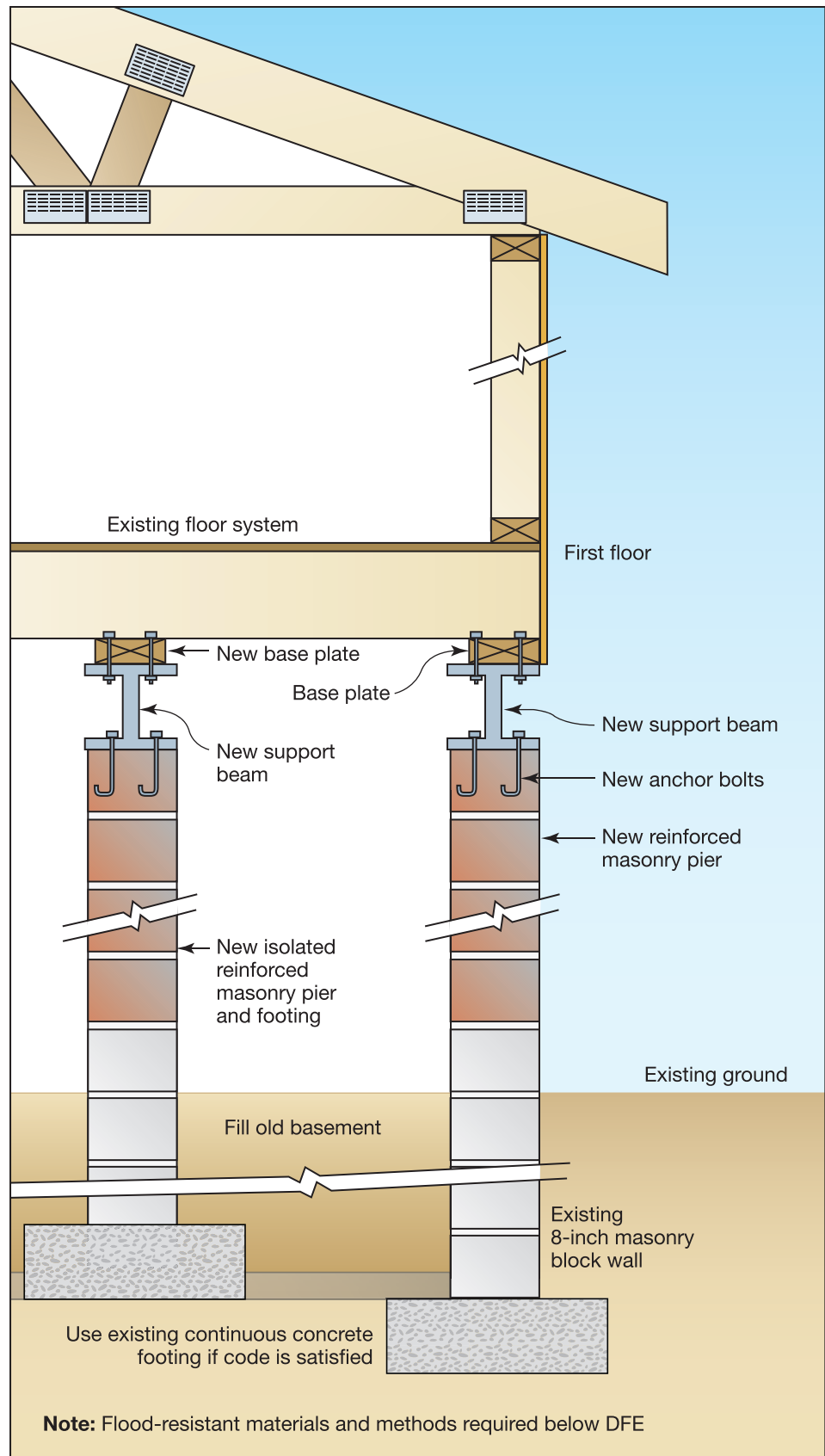

Figure 5E-10. Cross-section of elevated wood-frame house with extended masonry-enclosed area on top of an abandoned and filled-in basement



Figure 5E-11.  
Cross-section of elevated  
wood-frame house on  
top of the existing filled-  
in basement



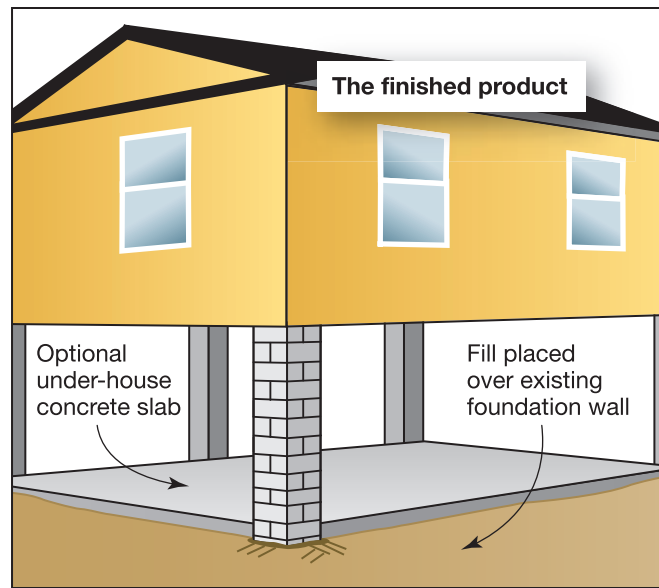

Figure 5E-12. Elevated wood-frame house set on new reinforced piers on top of the existing filled-in basement

### 5E.1.2.1 Design of Openings in Foundation Walls for Intentional Flooding of Enclosed Areas Below the DFE

It is important that the foundation walls contain openings that will permit the automatic entry and exit of floodwater for buildings that are constructed on extended solid foundation walls or that have other enclosures below the DFE (see Figure 5E-13).

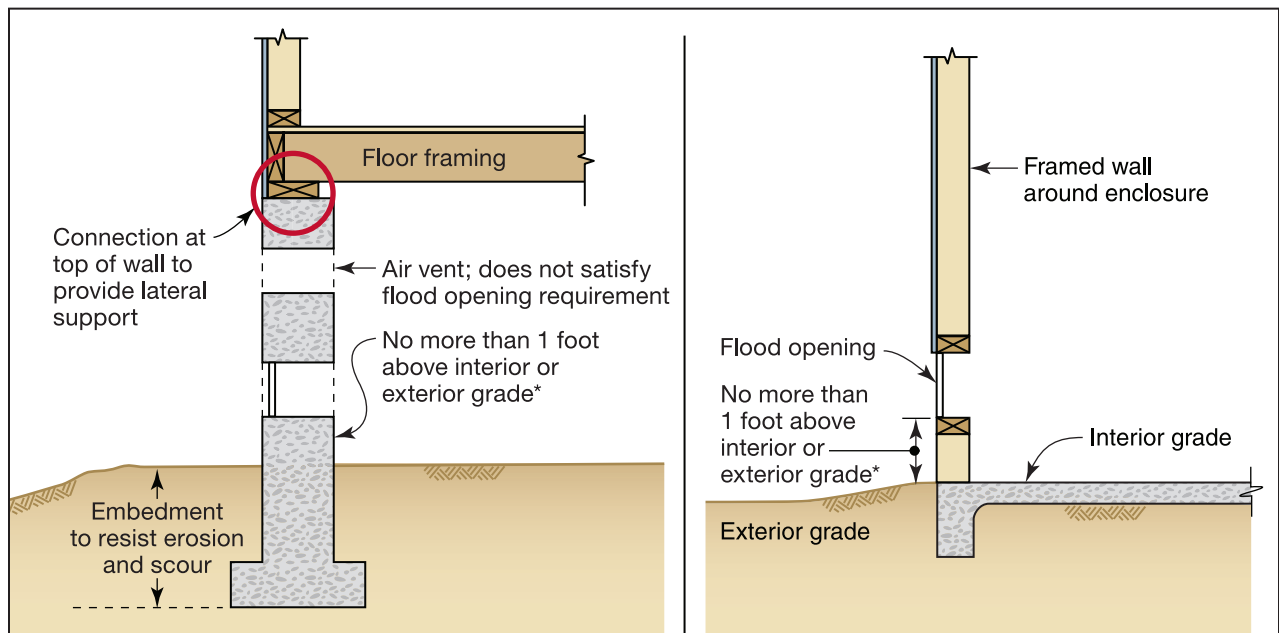

Figure 5E-13. Typical opening for solid foundation wall

These openings allow floodwater to reach equal levels on both sides of the walls and thereby lessen the potential for damage from hydrostatic pressure. While not a requirement for existing buildings built prior to a community’s joining the NFIP, NFIP regulations require these openings for all new construction and substantial improvements of existing buildings in SFHAs.

The minimum criteria for design of these openings are:

- a minimum of two openings must be provided on different sides of each enclosed area, having a total net area of not less than 1 square inch for every square foot of enclosed area subject to flooding; this is not required if openings are engineered and certified;
- the bottom of all openings shall be no higher than 1 foot above grade; and
- openings may be equipped with screens, louvers, or other coverings or devices, provided those components permit the automatic entry and exit of floodwater and do not reduce the net open area to less than the required open area.



**CROSS REFERENCE**

For additional information on the regulations and design guidelines concerning foundation openings, please refer to FEMA’s NFIP Technical Bulletin 1-08, Openings in Foundation Walls for Buildings Located in Special Flood Hazard Areas in Accordance with the National Flood Insurance Program (FEMA, 2008).

It is important to make sure that none of the flood openings will be obstructed during a flood event. In wet floodproofed buildings, openings are sometimes obstructed by drywall or other wall coverings (Figure 5E-14), which can result in significant damage if the opening does not operate as intended. Figure 5E-15 shows an NFIP-compliant house with attached garage with flood openings to prevent the build-up of hydrostatic loads on the foundation walls.



**Figure 5E-14.** A house where flood openings have been covered by insulation and drywall

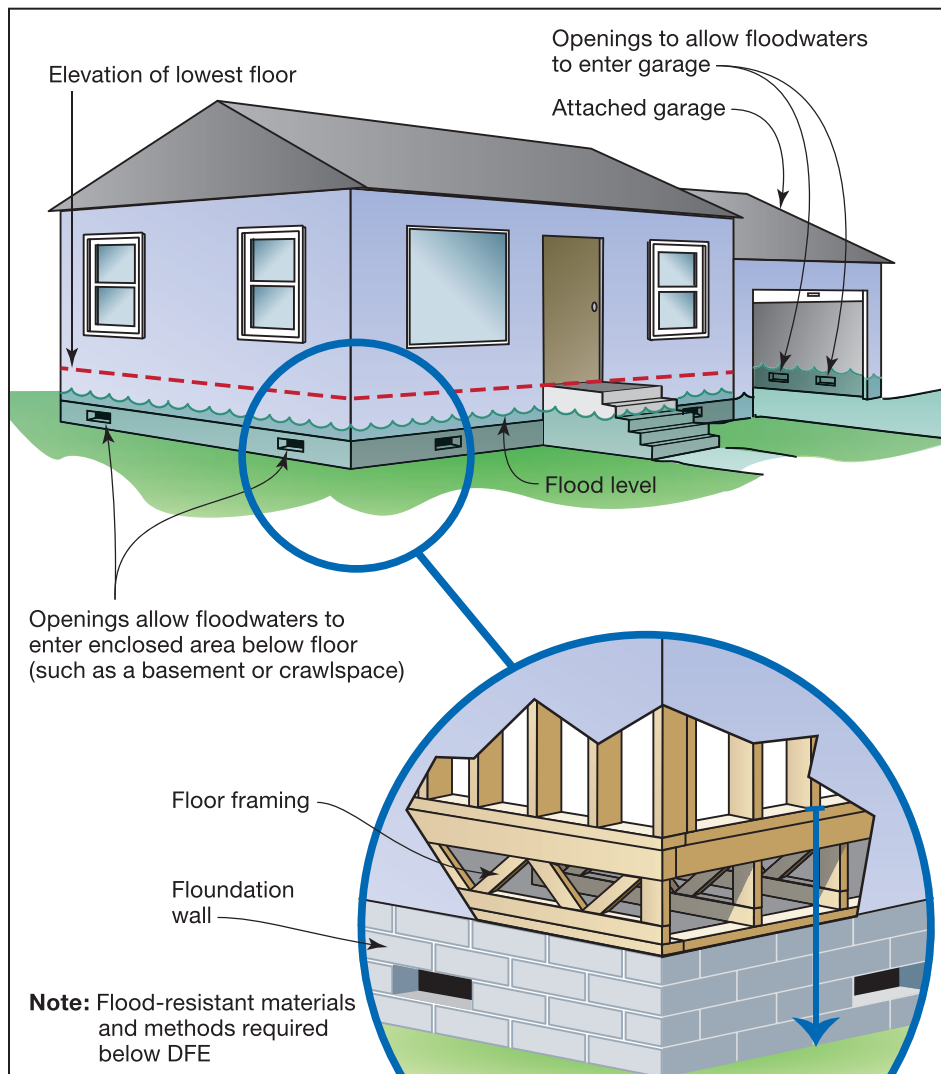

Figure 5E-15.  
NFIP-compliant house built  
on solid foundation walls  
with attached garage

### 5E.1.3 Houses on Piers, Columns, or Piles

The process of elevating a house on existing piers, columns, or piles is slightly more complex in that temporary relocation of the house may be part of the elevation process. With the use of this type of foundation, the house may need to be lifted off the existing foundation and temporarily relocated on site. The existing foundation is then removed and/or reconstructed, and the house is reset on the new foundation. In some instances, raising the home above the working area (instead or relocating off to the side) may provide sufficient room to install new pier and column foundations and to extend existing piers or columns upward.

### 5E.1.4 Slab-on-Grade Houses

Although slab-on-grade houses may be the most difficult to raise, a number of elevation options exist with regard to raising the structure with or without the slab and using a first floor composed of wood or concrete. If the slab is to be raised with the house, a trench is normally dug under the house to provide a space for inserting lifting beams. However, intrusive techniques that place beams through the structural walls have

proved to be successful in elevating some slab-on-grade homes, as well. If the existing slab is to remain in place, the house must be detached from the slab, the structure must be raised separately from the slab, and a new floor system must be built along with an elevated foundation.

#### 5E.1.4.1 Elevating a Slab-on-Grade Wood-Frame House

The following procedures apply to elevating a wood-frame house with a slab-on-grade foundation:

- Elevating without the slab, using a new first floor constructed of wood trusses (see Figures 5E-16 through 5E-20); and
- Elevating with the slab intact (see Figures 5E-21 through 5E-23). The basic order of steps required for raising a slab on grade house with slab intact is illustrated in Figures 5E-21 through 5E-23; implementation demands highly specialized skill and equipment that are beyond the scope of this manual.

**Figure 5E-16.**  
Existing wood-frame  
house with slab and  
stem-wall foundation

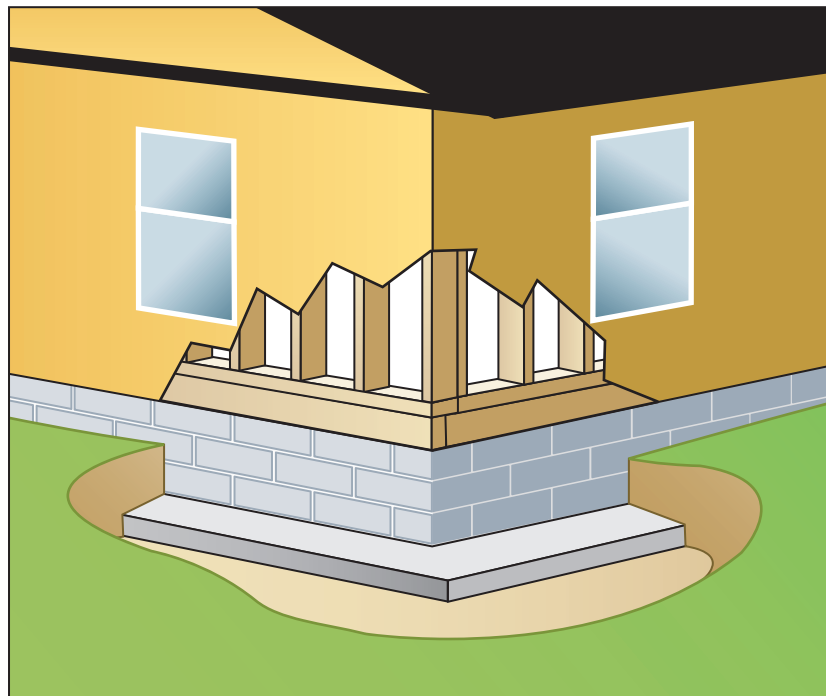

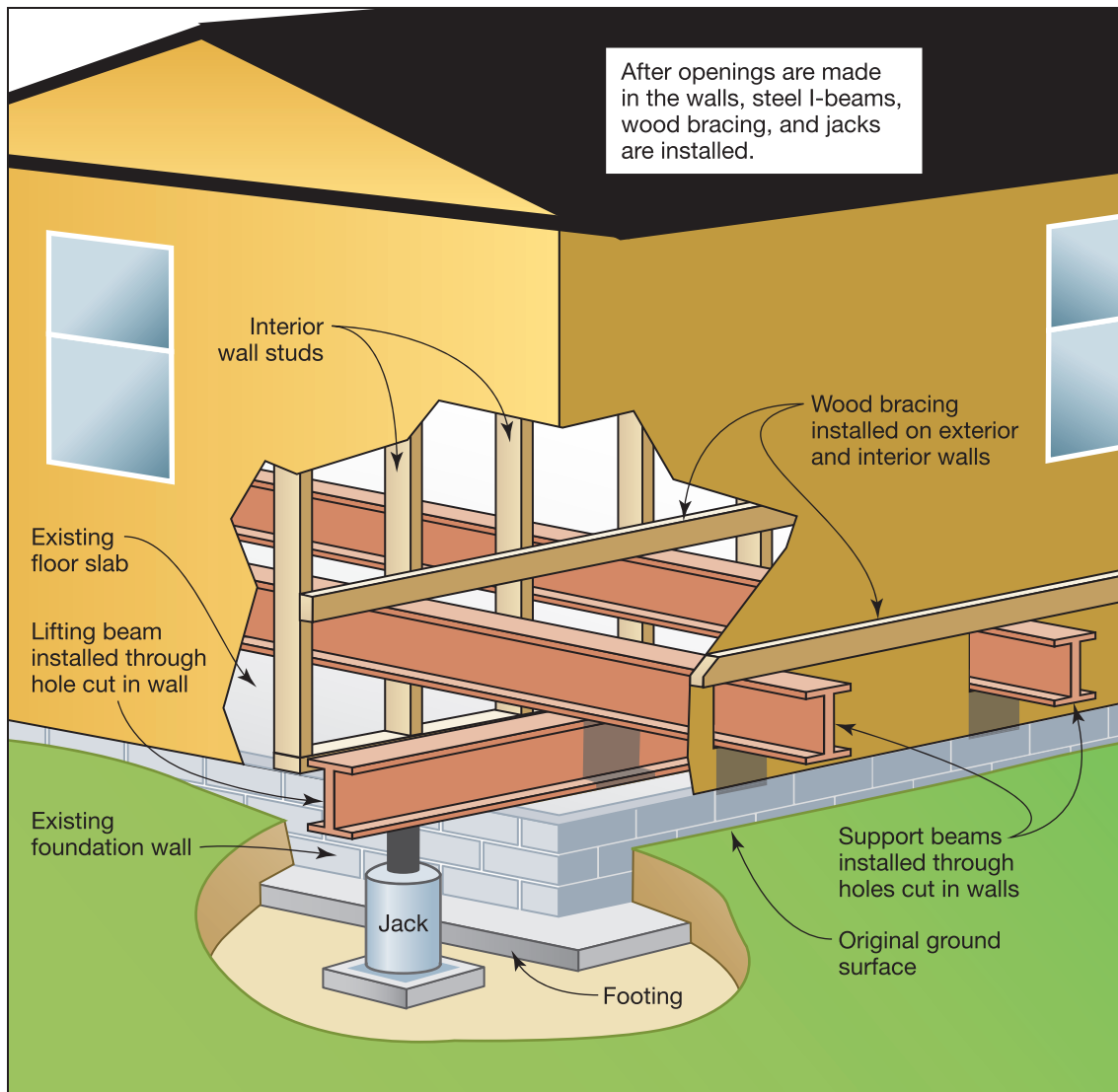

Figure 5E-17. Step 1 of elevating an existing wood-frame house without the slab using a new first floor constructed of wood trusses: Install steel I-beam network and prepare to lift walls



Figure 5E-18.  
 Step 2 of elevating an existing wood-frame house without the slab using a new first floor constructed of wood trusses: Lift house, extend masonry foundation wall, and install wood floor trusses; relocate utility and mechanical equipment above flood level

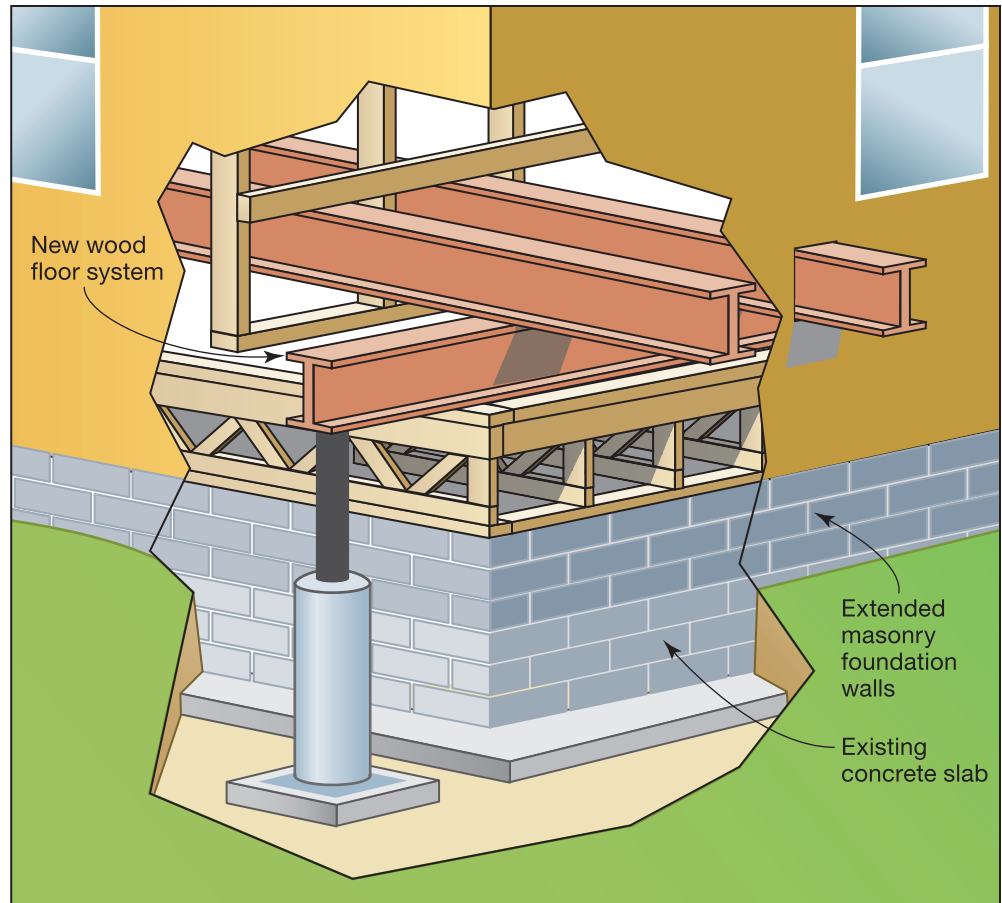
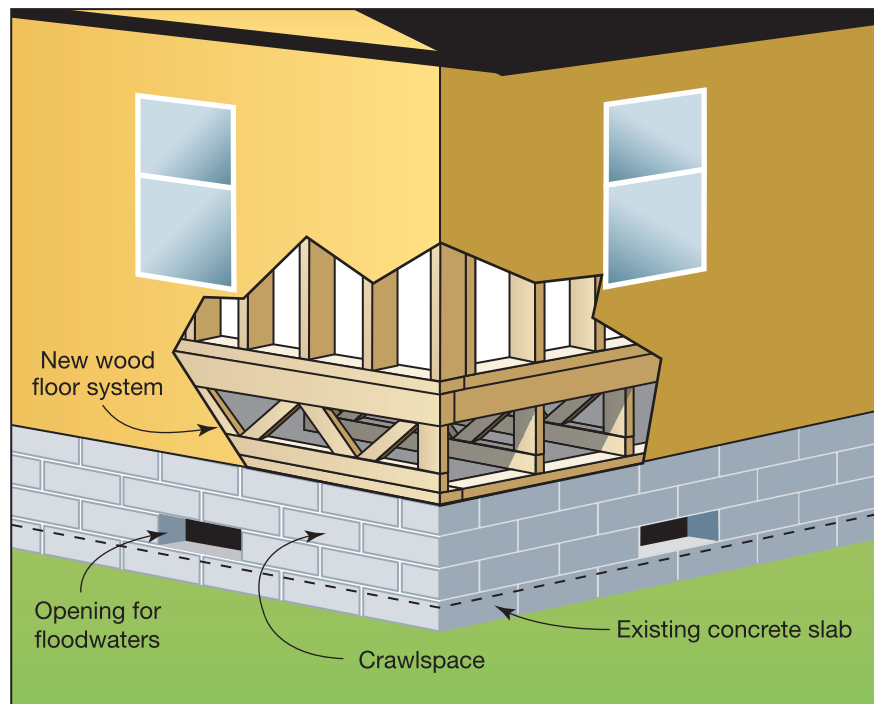
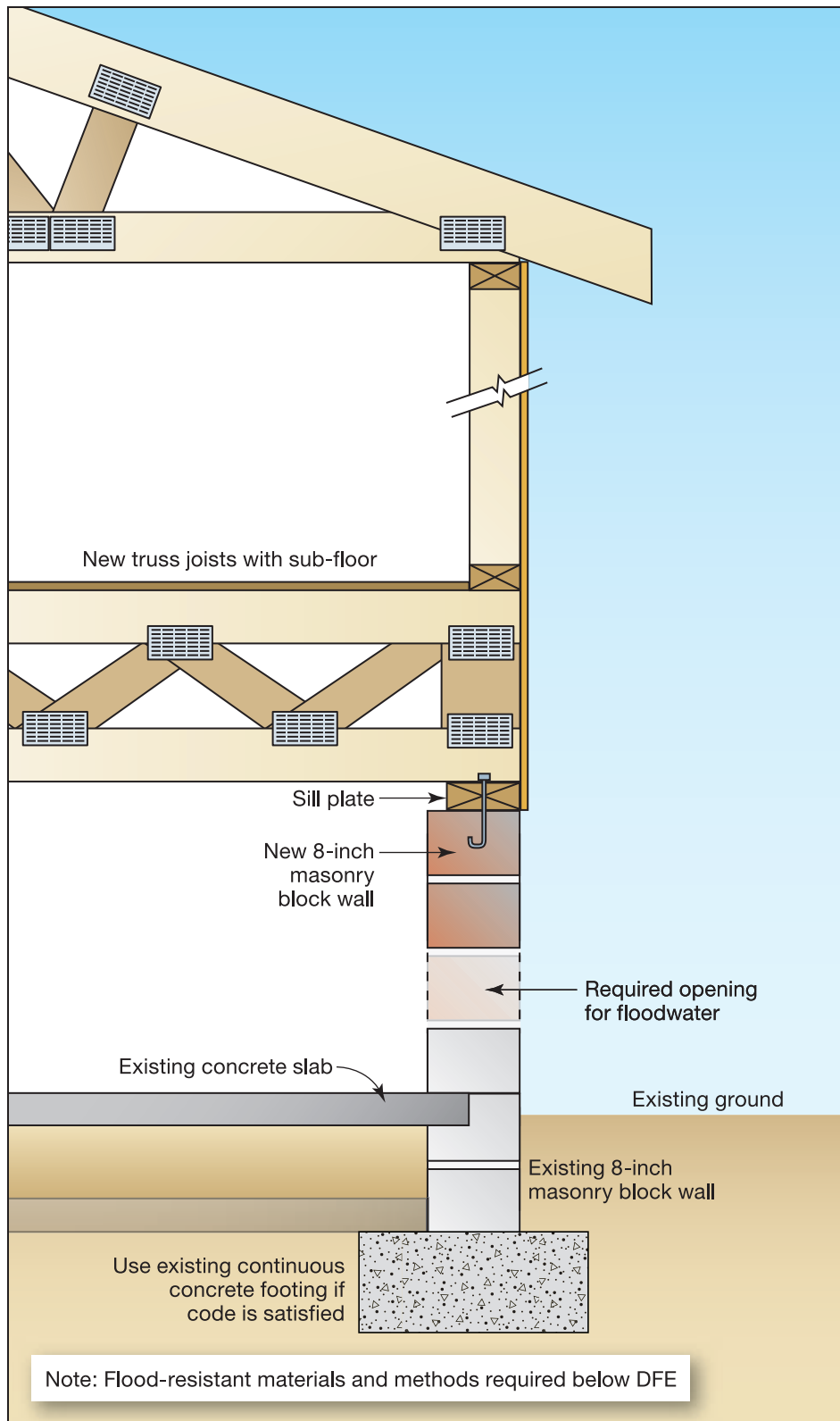

Figure 5E-19.  
 Step 3 of elevating an existing wood-frame house without the slab and with extended stem wall using a new first floor constructed of wood trusses: Set house on new foundation and remove I-beams





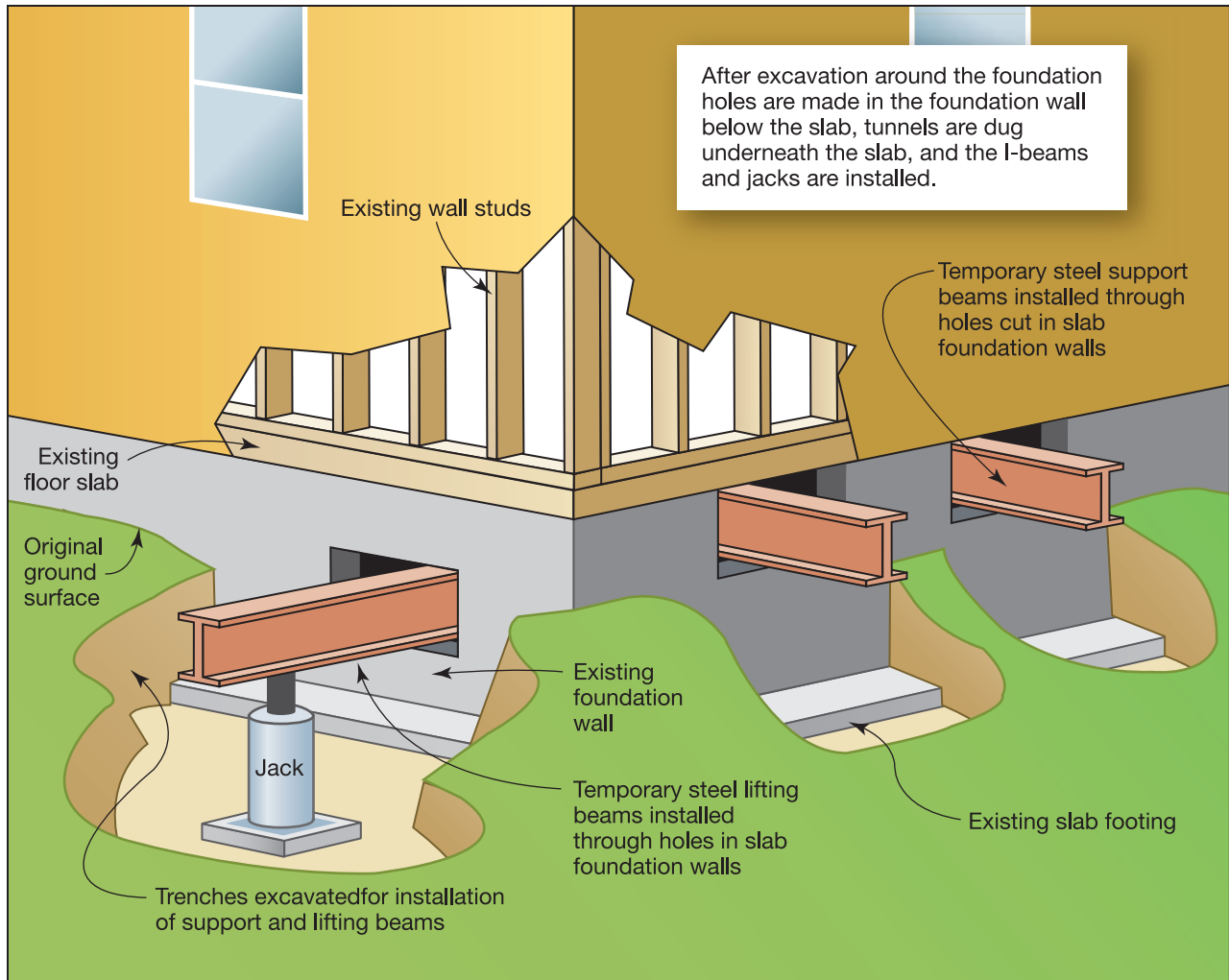

Figure 5E-21. Step 1 of elevating an existing wood-frame house with stem wall foundation and the slab intact: Excavate under existing slab and install network of steel I-beams. Step 2 (not shown): Raise the wood-frame house with the slab intact, extend foundation stem walls, and install new piers.

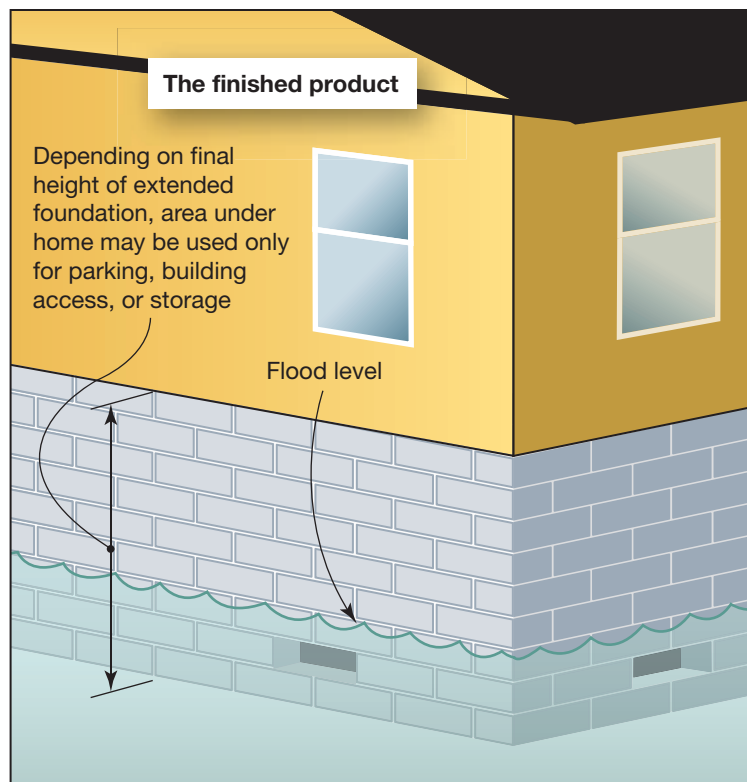

Figure 5E-22.  
Step 3 of elevating an existing wood-frame house with stem wall foundation and the slab intact: Set the house on the new foundation and remove the I-beams

#### 5E.1.4.2 Elevating a Slab-on-Grade Masonry House

The following alternatives apply to elevating a masonry house with a slab-on-grade foundation:

- elevate a slab-on-grade masonry structure with the slab intact;
- elevate a slab-on-grade masonry structure without the slab, and using a first floor constructed of wood framing;
- install an elevated concrete slab within an existing masonry structure;
- install an elevated wood-frame floor system within an existing masonry structure;
- create a new masonry livable area on top of an existing one-story masonry structure; and
- create a new wood-frame livable area on top of an existing one-story masonry structure.

#### 5E.1.5 Heavy Building Materials/Complex Design

The elevation process becomes even more complex with added weight, height, or complex design of the house. Brick or stucco veneers may require removal prior to elevation. Combination foundations (i.e., slab-on-grade and basement) should be evaluated jointly, as well as separately, and the worst case scenario utilized for design purposes. Building additions may need to be elevated independently from the main structure. Due to the extreme variability of structural conditions, a structural engineer should evaluate the suitability of lifting this type of home.

Figure 5E-23.  
Cross-section of elevated  
wood-frame house with  
stem wall foundation and  
the slab intact

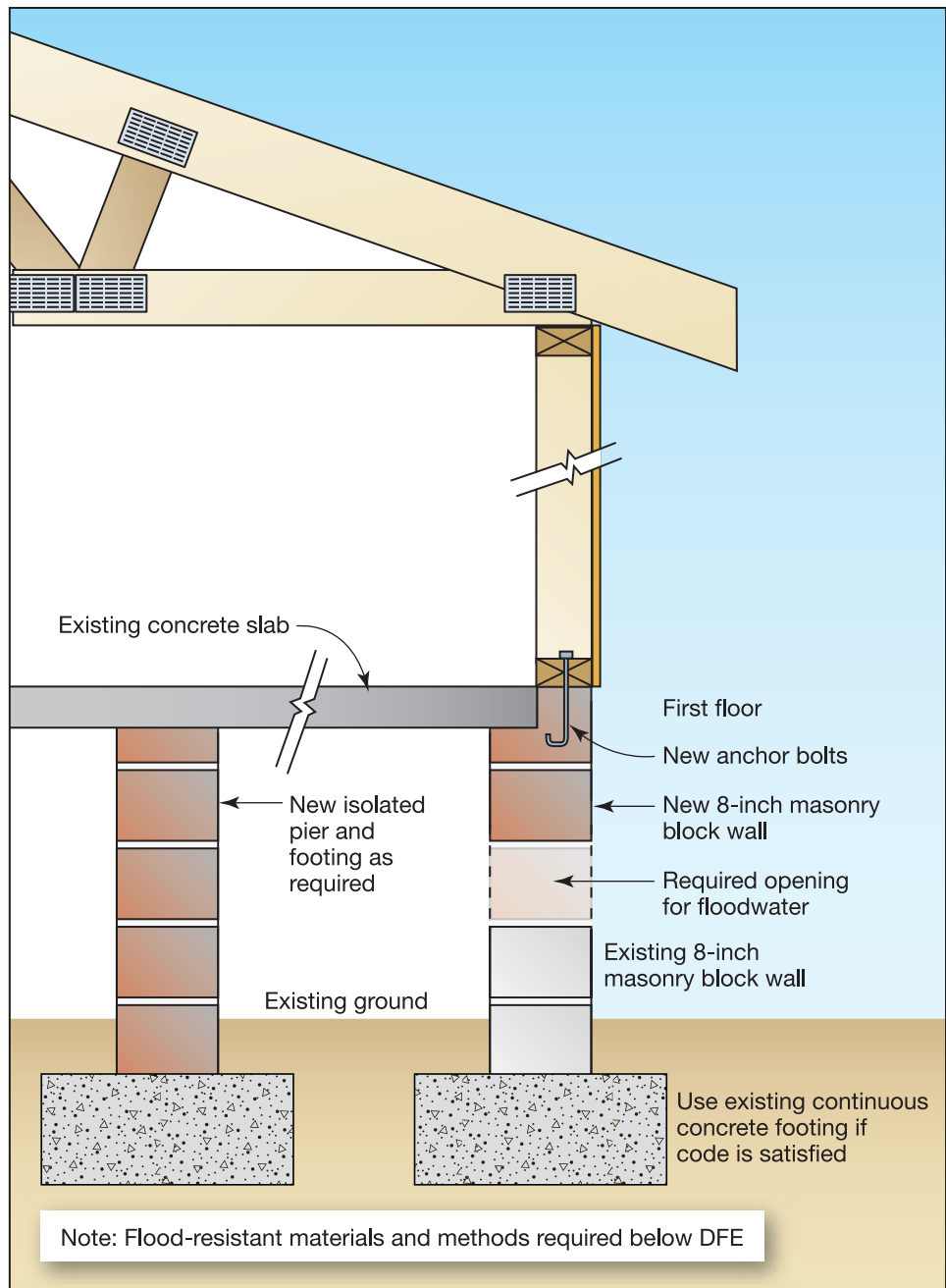

The entire elevation design process is illustrated with a detailed example of the design for a crawlspace house (Figure 5E-24).

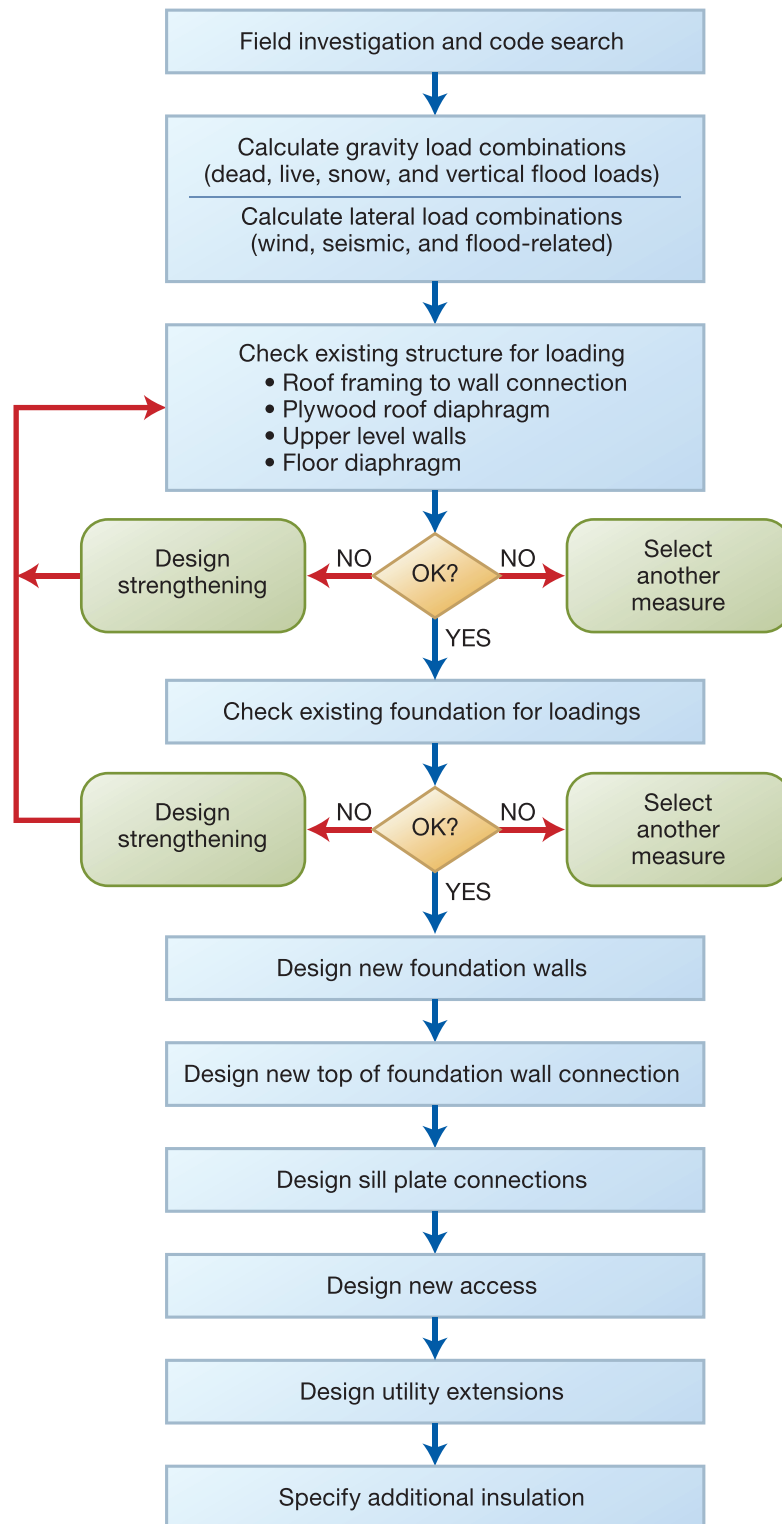

Figure 5E-24.  
Design process for  
an elevated house on  
foundation walls



## 5E.2 Field Investigation Concerns

To determine whether elevation is an appropriate retrofit technique for a particular building, a field investigation should be performed. In addition to a site visit and inspection, a data review and code search should be conducted.

### 5E.2.1 Property Inspection and Existing Data Review

During the field investigation, the designer should inspect the property and review existing data to confirm the applicability of the selected alternative and to confirm specific design guidance such as the height of elevation and type of foundation to be utilized. The designer should utilize the guidance presented in Chapter 5. Much of the data has been previously discussed in Chapters 3 and 4. At a minimum, the designer should collect information on the checklist in Figure 5E-25.

### 5E.2.2 Code Search

During the field investigation, the designer should also conduct a search of local floodplain ordinances, local and State building codes, restrictions to deeds, restrictions in subdivisions, and zoning regulations. In addition, a visit with the local building official should be planned to determine any special requirements for the locality. During the code search, the following should be determined:

- elevation and foundation requirements per the floodplain ordinance and flood hazard map;
- requirements of the building code that governs the elevation project;
- design wind speed;
- design seismic zone;
- ground snow loads;
- frost depths;
- restrictions on height (overall building, portions of building relative to materials in use, allowable height/thickness ratios); and
- restrictions on foundations.

Elevation Field Investigation Worksheet	
Owner Name: _____	Prepared By: _____
Address: _____	Date: _____
Property Location: _____	
Does site topography data cover required area? <input type="checkbox"/> Yes <input type="checkbox"/> No	
Additional data required:	
Any construction access issues?	
Site and building utilities identified?	<input type="checkbox"/> Yes <input type="checkbox"/> No
Potential utility conflicts identified?	<input type="checkbox"/> Yes <input type="checkbox"/> No
Describe conflicts: _____	
Review homeowner preferences: _____	
Can aesthetics reconcile with site and building constraints? <input type="checkbox"/> Yes <input type="checkbox"/> No	
How?	
Confirm type and condition of existing framing:	
<input type="checkbox"/> member sizes	<input type="checkbox"/> spans
<input type="checkbox"/> connections	<input type="checkbox"/> supports
Confirm type and condition of foundation:	
<input type="checkbox"/> type	<input type="checkbox"/> depth
<input type="checkbox"/> size	
Confirm types and condition of existing construction materials:	
<input type="checkbox"/> roof	<input type="checkbox"/> floor
<input type="checkbox"/> walls	<input type="checkbox"/> foundation
Confirm soil information:	
<input type="checkbox"/> type	<input type="checkbox"/> depth of rock
<input type="checkbox"/> bearing capacity	<input type="checkbox"/> susceptibility to erosion and scour
Confirm characteristics of flood-related hazards:	
<input type="checkbox"/> base flood elevation (BFE)	<input type="checkbox"/> velocity
<input type="checkbox"/> design flood elevation (DFE)	<input type="checkbox"/> frequency
<input type="checkbox"/> duration	<input type="checkbox"/> potential for debris flow
Confirm characteristics of non-flood-related hazards:	
<input type="checkbox"/> wind	<input type="checkbox"/> seismic
<input type="checkbox"/> snow	<input type="checkbox"/> other
Review accessibility considerations:	
<input type="checkbox"/> access/egress	<input type="checkbox"/> special resources for elderly, disabled, children
Architectural constraints noted: _____	
Is clearance available to install lifting beams and jacking equipment? <input type="checkbox"/> Yes <input type="checkbox"/> No	
Check local codes/covenants for height or appearance restrictions:	
<input type="checkbox"/> deed/subdivision rules	<input type="checkbox"/> local building codes
Restrictions: _____	

Figure 5E-25. Elevation Field Investigation Worksheet

## 5E.3 Design

The design process for an elevated structure shown in Figure 5E-24 consists of the following steps:

**Step 1:** Calculate the vertical loads.

The computation of vertical loads, which includes building dead and live loads (gravity loads) and buoyancy forces, was presented in Chapter 4.

**Snow Loads:** There are no “typical” equations for houses, since the calculation of snow loads depends on the building code in use, the geographic area in which the house is located, and the size and shape of the house and roof. The governing building code will clearly spell out the correct procedure to follow. Most procedures are simple and straightforward. Some houses will be more complex due to their shape or the quantity of snow that must be allowed for. However, the general procedures are as follows:

- consult snow maps in the building code and/or local requirements with the local building official to determine the ground snow load;
- determine the importance factors;
- analyze the surrounding terrain, trends in snow patterns, and slope of roof to determine the exposure factors;
- determine the snow load;
- determine the considerations for drifting snow by examining any adjacent house or structure, a mountain above the house, or higher roofs; and
- determine the considerations for sliding snow by examining the steep slope on the roof or higher roofs.

**Step 2:** Calculate the lateral loads.

The calculation of building lateral loads includes wind, seismic, and flood-related loads. One objective of the wind and seismic analysis is to determine which loading condition controls the design of specific structural components.

**Wind Analysis:** There are no “typical” equations for houses, since the calculation of wind loads depends upon the building code in use and the size and shape of the house. The governing building code will clearly spell out the correct procedure to follow. Most procedures are simple and straightforward. Some houses will be more complex due to their shape. However, the general procedure, as discussed in Chapter 4, is presented below.



### CROSS REFERENCE

To illustrate the design process, a worked example is shown in Appendix C for Steps 1-7. Information on Step 9 is presented in Chapter 5F. The designer should refer to local codes for guidance on Steps 8 and 10. The example demonstrates numerous considerations necessary for an elevation project, but is not technically exhaustive.



### NOTE

If the governing building code does not provide applicable guidance on loading associated with flooding, wind, seismic, or snow, refer to ASCE 7.

- determine the wind speed and pressure by consulting wind maps within the building code, and checking local requirements with the local building official;
- determine the importance factors and the exposure category;
- determine the wind gust and exposure factors and analyze the building height and shape, whether the wind is parallel or perpendicular to the roof ridge, and whether it is windward or leeward of roofs/walls;
- determine the wind load; and
- distribute the load to resisting elements based upon the stiffness of shear walls, bracing, and frames.

**NOTE**

ASCE 7 and the IRC provide basic wind speed maps showing wind velocities and frequencies. If the local code enforced is the IRC, the designer should refer to the IRC wind speed map (Figure 4-19). If no local code is in force, the designer should refer to ASCE 7, Minimum Design Loads for Buildings and Other Structures.

**Seismic Analysis:** There are no “typical” equations for houses since the calculation of seismic loads depends upon the building code in use and the size and shape of the house. The governing building code will clearly spell out the correct procedures to follow. Some houses will be more complex due to their shape. However, the general procedures, as discussed in Chapter 4, are presented below.

- calculate the dead loads by floor, including permanent dead loads (roof, floor, walls, and building materials) and permanent fixtures (cabinets, mechanical/electrical fixtures, stairs, new locations for utilities, etc.);
- determine if the snow load must be included in the dead load analysis; most building codes require the snow load to be included for heavy snow regions and will list these requirements;
- determine the seismic zone and importance factors;
- determine the fundamental period of vibration (height of structure materials used in building);
- determine the total seismic lateral force by analyzing site considerations, building weights, and the type of resisting system;
- distribute the loads vertically per the building code, keeping in mind the additional force at the top of the building; and
- distribute the loads horizontally according to the building code and the stiffness of resisting elements. The code-prescribed minimum torsion of the building (center of mass versus center of rigidity), shear walls, bracing, and frames must be considered.

**Flood-Related Forces:** The computation of flood-related forces was presented in Chapter 4 and includes the following:

- determine the DFE;
- determine the types of flood forces (hydrostatic or hydrodynamic);
- determine the susceptibility to impacts from debris (ice, rocks, trees, etc.);

- determine the susceptibility to scour;
- determine the applicability of and susceptibility to alluvial fans;
- determine the design forces; and
- distribute the forces to resisting elements based upon stiffness.

**Step 3:** Check ability of existing structure to withstand additional loading.

Chapter 4 presented general information on determining the ability of the existing structure to withstand the additional loadings imposed by retrofitting methods. The process detailed below is similar for each of the building types most people will encounter. First, the expected loadings are tabulated and compared against allowable amounts determined from soil conditions, local code standards, or building material standards. The following list of existing building components and connections should be checked.

**Roofs:** The plywood roof diaphragm, trusses, connections, and uplift on roof sheathing should be capable of resisting the increased wind and seismic loads. The Engineered Wood Association (<http://www.apawood.org>) has published several references that are useful in this calculation, including APA SR-1013, *Design for Combined Shear and Uplift from Wind* (APA, 2011) and APA Form T325, *Roof Sheathing Fastening Schedules for Wind Uplift* (APA, 2006).

These reference materials or the local building codes will give the designer the necessary plywood thicknesses and connection specifications to resist the expected loadings and/or will provide loading ratings for specific material types and sizes.

If the roof diaphragm and sheathing are not sufficient to resist the increased loading, the design can strengthen these components by:

- increasing the thickness of the materials; and/or
- strengthening the connections with additional plates and additional fasteners.

**Roof Framing-to-Wall Connections:** The roof framing connections to walls should be checked to ensure that they will resist the increased wind loads. Of critical importance are the gable ends, where many wind failures occur. The Engineered Wood Association has published several references that are useful in this calculation, including APA SR-1013, *Design for Combined Shear and Uplift from Wind* (APA, 2011) and APA Form L350, *Diaphragms and Shear Walls* (APA, 2007).

These reference materials or the local building codes will give the designer the necessary truss size, configuration, and connection specifications to resist the expected loadings, and/or will provide loading ratings for specific truss and connection types and sizes.

If the roof trusses and wall connections are not sufficient to resist the increased loading, the design can strengthen these components by:



### CROSS REFERENCE

For additional information on the performance of various building system products, refer to product evaluation reports prepared by the model code groups or the National Evaluation Service (NES).

- increasing the amount of bracing between the trusses; and/or
- strengthening the connections with additional plates and additional fasteners.

**Upper Level Walls:** The upper level walls are subject to increased wind pressure and increased shear due to increased roof loads. Both the short and long walls should be checked against the shear, torsion, tension, and deflection, utilizing the governing loading condition (wind or seismic).

The Engineered Wood Association has published several references that are useful in this calculation, including APA SR-1013, *Design for Combined Shear and Uplift from Wind* (APA, 2011) and APA Form L350, *Diaphragms and Shear Walls* (APA, 2007).

These reference materials or the local building codes will give the designer the necessary wall size and configuration and connection specifications to resist the expected loadings and/or will provide loading ratings for specific wall types, sizes, and connection schemes.

If the upper level walls are determined to be unable to withstand the increased loadings, the designer is faced with the difficult task of strengthening what amounts to the entire house. In some situations, this may be cost-prohibitive, and the homeowner should look for another retrofitting method, such as relocation. Measures the designer could utilize to strengthen the upper level walls include:

- adding steel strapping (cross bracing) to interior or exterior wall faces;
- adding a new wall adjacent to the exterior or interior of the existing wall;
- bolstering the interior walls in a similar fashion; and/or
- increasing the number and sizes of connections.

**Floor Diaphragm:** The floor diaphragm and connections are subject to increased loading due to wind, seismic forces, and flood. The existing floor diaphragm and connections should be checked to ensure that they can withstand the increased forces that might result from the elevation.

The Engineered Wood Association has published several references that are useful in this calculation, including APA Form Y250, *Shear Transfer at Engineered Wood Floors* (APA, 1999) and APA Form L350, *Diaphragms and Shear Walls* (APA, 2007).

These reference materials or the local building codes will give the designer the necessary floor size and configuration and connection specifications to resist the expected loadings, and/or will provide loading ratings for specific floor types, sizes, and connection schemes.

If the floor diaphragm or connections are determined to be unable to withstand the increased loadings, the designer could strengthen these components by:

- adding a new plywood layer on the bottom of the existing floor diaphragm;
- increasing the number and size of bracing within the floor diaphragm; and
- increasing the number and size of connections.

**Step 4:** Analyze the existing foundation.

The existing foundation should be checked to determine its ability to withstand the increased gravity loads from the elevation, the increased lateral loads due to soil pressures from potential backfilling, and the increased overturning pressures due to seismic and wind loadings. The designer should tabulate all of the gravity loads (dead and live loads) plus the weight of the new foundation walls to determine a bearing pressure, which is then compared with the allowable bearing pressure of the soil at the site. Not including expected buoyancy forces in this computation will yield a conservative answer.

If the existing footing is insufficient to withstand the additional loadings created by the elevated structure, the design of foundation supplementation should be undertaken. The foundation supplementation may be as straightforward as increasing the size of the footing and/or more substantial reinforcement. The designer may refer to the ACI manual for footing design, recent texts for walls and footing design, and applicable codes and standards.

**Step 5:** Design the new foundation walls.

The design of a new foundation, whether solid or open, is usually governed by the local building codes. These codes will have minimum requirements for foundation wall sizes and reinforcing schemes, including seismic zone considerations. The designer should consult the appropriate code document tables for minimum requirements for vertical wall or open foundation reinforcement.

**CROSS REFERENCE**

For wet floodproofing applications, where openings in foundation walls are necessary, refer to Chapter 5W, Wet Floodproofing.

For new slab applications where the lower level is allowed to flood and the slab is not subject to buoyancy pressures, the designer can use the Portland Cement Association document *Concrete Floors on Ground* (2008) as a source of information to select appropriate thicknesses and reinforcing schemes based upon expected loadings. The slab loadings will vary based upon the overall foundation design and the use of the lower floor.

**Step 6:** Design top of foundation wall connections.

Top of wall connections are critical to avoid pullout of the sole plate, floor diaphragm, and/or sill plate from the masonry foundation. A preliminary size and spacing of anchor bolts is assumed, and uplift, shear, and tension forces are computed and compared against the allowable loads for the selected bolts. Where necessary, adjustments are made to the size and spacing of the anchor bolts to keep the calculated forces below the allowable forces. Connections should be designed for all appropriate load combinations as discussed in Chapter 5.

**Step 7:** Design the sill plate connections.

The existing sill plate connections will be subject to increased lateral loads and increased uplift forces due to increased wind and buoyancy loading conditions. The sill plate is designed to span between the anchor bolts and resist bending and horizontal shear forces. The designer should refer to the appropriate wood design manual that provides recommended compression, bending, shear, and elasticity values for various sill plate materials. Using these values, the designer checks the connection against the expected forces to ensure that the actual forces are less than the allowable stresses. If the sill plate connection is insufficient to withstand expected loadings, the size of the sill plate can be increased (or doubled), and/or the spacing of the anchor bolts can be reduced.



**Step 8:** Design new access.

The selection and design of new access to an elevated structure is done in accordance with local regulations governing these features. Special homeowner requirements, such as for aesthetics, handicapped accessibility, and/or special requirements for children and the elderly, can be incorporated using references previously discussed in Chapter 3.

Incorporating the new access often applies to multiple egress locations and may present a unique challenge to the designer as greater area is required on the existing site to accommodate the increase in elevation from adjacent grade to egress. A particular obstacle may arise with attached garages where the living space is elevated and the garage slab remains at original grade as allowed for areas designated for building access, parking, and storage only. Besides the area and height constraints required for the additional stairs to the elevated egress, the designer must also resolve drainage and aesthetic issues created by the newly discontinuous roof system.

Connection of the new access to the house should be designed in accordance with the local codes. The foundation for the access measure will either be freestanding and subject to its own lateral stability requirements or it will be an integral part of the new elevated structure. In either case, analysis of the structure to ensure adequate foundation strength and lateral stability should be completed in accordance with local codes.

It should be noted that any access below the BFE should incorporate the use of flood-resistant materials. The designer should refer to FEMA's NFIP Technical Bulletin 2-08, *Flood Damage-Resistant Materials Requirements for Buildings Located in Special Flood Hazard Areas in Accordance with the National Flood Insurance Program* (FEMA, 2008).

**Step 9:** Design the utilities extensions.

The field investigation will reveal the specific utility systems that will require relocation, extension, or modification. Whenever possible, utility systems should be relocated above the DFE. Local utility companies should be contacted about their specific requirements governing the extension of their utility service. In many instances, the local utility company will construct the extension for the homeowner. Critical issues in this extension process include:

- handling of utilities encased in the existing slab or walls;
- coordination of disconnection and reconnection;
- any local codes that require upgrades to the utility systems as part of new construction or substantial repair or improvement;
- introduction of flexible connections on gas, water, sewer, and oil lines to minimize potential for seismic damage;
- potential for relocation or elevation of electrical system components from existing crawlspace and/or basement areas; and
- design of separate GFI-type electrical circuits and use of flood-resistant materials in areas below the BFE.

**CROSS REFERENCE**

Guidance on the selection of an elevation or relocation contractor is provided in Chapter 5R, Relocation.

**Step 10:** Specify the increased insulation requirements.

Elevated floors and extended utility system components may increase the potential for heat loss through increased exposure and airflow and necessitate additional insulation. The designer should evaluate the energy efficiency of each aspect of the project, compare existing insulation (R-values) against the local building code, and specify additional insulation (greater R-value) where required.

## 5E.4 Construction Considerations

Following are some important points for consideration both prior to and during implementation of a structure elevation project.

Prior to elevating any house:

- obtain all permits and approvals required;
- ensure that all utility hookups are disconnected (plumbing, phone, electrical, cable, and mechanical);
- estimate the lifting load of the house; and
- identify the best location for the principal lift beams, lateral support beams, and framing lumber, and evaluate their adequacy (generally performed by a structural engineer or the elevation contractor).

### 5E.4.1 Slab-on-Grade House, Not Raising Slab with House

Procedures for elevating a slab-on-grade house without raising the slab:

- holes are cut for lift beams in the exterior and interior walls;
- main lifting beams are inserted;
- holes are cut for the lateral beams;
- lateral beams are inserted;
- bracing is installed to transfer the loads across the support walls and lift remaining walls;
- jacks are moved into place and structure is prepared for lifting;
- straps and anchors used to attach house to slab-on-grade are released;
- the house is elevated and cribbing installed;
- slab around edges is removed to allow for new foundation;
- the new foundation is constructed;
- new support headers and floor system are installed;
- any required wind and seismic retrofit is completed;

- house is attached to new foundation;
- all temporary framing is removed, holes are patched;
- all utilities are reconnected;
- new stairways and access are constructed; and
- all utilities below the DFE are floodproofed.

### 5E.4.2 Slab-on-Grade House, Raising Slab

Procedures for elevating a slab-on-grade house and raising the slab:

- trenches are excavated for placement of all support beams beneath slab;
- lifting and lateral beams are installed;
- jacks are moved into place and the structure is prepared for lifting;
- the house is elevated and cribbing installed;
- the new foundation is constructed;
- any required wind and seismic retrofit is completed;
- house is attached to new foundation;
- support beams are removed;
- access holes are patched;
- all utilities are reconnected;
- new stairways and access are constructed; and
- all utilities below the DFE are floodproofed.

### 5E.4.3 House Over Crawlspace/Basement

Procedures for elevating a house over a crawlspace or basement:

- masonry is removed as necessary to allow for placement of support beams;
- main lifting beams are installed;
- lateral beams are installed;
- jacks are moved into place and the structure is prepared for lifting;
- all connections to foundation are removed;

- house is elevated and cribbing installed;
- existing foundation walls are raised or demolished, depending on whether the existing foundation walls can handle the new loads;
- new footings and foundation walls are constructed if the existing foundation walls/footings cannot withstand the additional loading;
- basement is backfilled where appropriate;
- house is attached to new foundation;
- support beams are removed;
- access holes are patched;
- all utilities are reconnected;
- new stairways and access are constructed; and
- all utilities below the DFE are floodproofed.

#### **5E.4.4 House on Piers, Columns, or Piles**

If the house is to remain in the same location, the house will most likely need to be temporarily relocated to allow for the footing and foundation installation. If the house is being relocated within the same site, the footings should be constructed prior to moving the house. Procedures for elevating a house on piers, columns, or piles:

- main support beams are installed;
- lateral beams are installed;
- jacks are moved into place and the structure prepared for lifting;
- house is elevated and cribbing is installed;
- if the house is being relocated, see section 5R;
- existing foundation is demolished and removed and new pier and column foundation is installed or existing foundation elements are extended upward and reinforced as needed
- house is attached to new foundation;
- support beams are removed;
- all utilities are reconnected;
- new stairways and access are constructed; and
- all utilities below the DFE are floodproofed.



# 5F Floodwalls and Levees

A properly designed and constructed floodwall or levee can often be an effective device for repelling floodwaters. Both floodwalls and levees provide barriers against inundation, protect buildings from unequalized hydrostatic and hydrodynamic loading situations, and in some cases may deflect floodborne debris and ice away from buildings. However, floodwalls and levees differ in their design, construction, site characteristics, and application.

Floodwalls are structures constructed of manmade materials such as concrete or masonry. The selection of a floodwall design is primarily dependent on the type of flooding expected at the building's site. High water levels and velocities can exert hydrodynamic and hydrostatic forces and impact loads, which must be accounted for in the floodwall design. The composition of any type of floodwall must address three broad concerns:

- overall stability of the wall as related to the external loads;
- sufficient strength as related to the calculated internal stresses; and
- ability to provide effective enclosures to repel floodwaters.

These internal and external forces pose a significant safety hazard if floodwalls are not properly designed and constructed, or their design level of protection is overtopped. Additionally, a tall floodwall can become very expensive to construct and maintain, and can require additional land area for grading and drainage. Therefore, in most instances, residential floodwalls are practical only up to a height of 3 to 4 feet above



## NOTE

Under NFIP regulations, floodwalls and levees cannot be used to bring non-compliant structures into compliance.

The NFIP requires that all new construction and substantial improvements of residential structures within Zones A1–30 and AE and AH zones on the community's FIRM have the lowest floor (including basement) elevated to or above the base flood level. (44 CFR 60.3(c)(2))

existing grade, although residential floodwalls can be and are engineered for greater heights.

Levees are embankments of compacted soil that keep shallow to moderate floodwaters from reaching a structure. A well designed and constructed levee should resist flooding up to the design storm flood elevation, eliminating exposure to potentially damaging hydrostatic and hydrodynamic forces.

This chapter outlines the fundamentals of levee and floodwall design and provides the designer with empirical designs suitable to a limited range of situations.

## 5F.1 Floodwalls

Floodwalls as a flood mitigation measure in residential areas are not as common as many of the other retrofitting methods detailed in this manual. However, for instances where this measure is appropriate, the following sections provide details on important design and construction considerations.

### 5F.1.1 Types of Floodwalls

Figures 5F-1 and 5F-2 illustrate the use of floodwalls in typical residential applications. Figures 5F-3 and 5F-4 illustrate several types of floodwalls, including gravity, cantilever, buttress, and counterfort. The gravity and cantilever floodwalls are the more commonly used types.

#### 5F.1.1.1 Gravity Floodwall

As its name implies, a gravity floodwall depends upon its weight for stability. The gravity wall's structural stability is attained by effective positioning of the mass of the wall, rather than the weight of the retained materials. The gravity wall resists overturning primarily by the dead weight of the concrete and masonry construction. It is simply too heavy to be overturned by the lateral flood load.

Frictional forces between the concrete base and the soil foundation generally resist sliding of the gravity wall. Soil foundation stability is achieved by ensuring that the structure neither moves nor fails along possible failure surfaces. Figure 5F-5 illustrates the stability of gravity floodwalls. Gravity walls are appropriate for low walls or lightly loaded walls. They are relatively easy to design and construct. The primary disadvantage of a gravity floodwall is that a large volume of material is required. As the required height of a gravity floodwall increases, it becomes more cost-effective to use a cantilever wall.



#### WARNING

Placement of floodwalls in the floodway is not allowed under NFIP regulations. Additionally, floodwalls constructed in Zone V may be subject to wave forces, wave runup, and wave overtopping, so their design and siting must be considered carefully to avoid wave reflection or flow diversion toward buildings. Refer to NFIP Technical Bulletin 5-08, Free-of-Obstruction Requirements (FEMA, 2008c) for additional details.



#### WARNING

Placement of levees in the floodway is not allowed under local floodplain regulations.



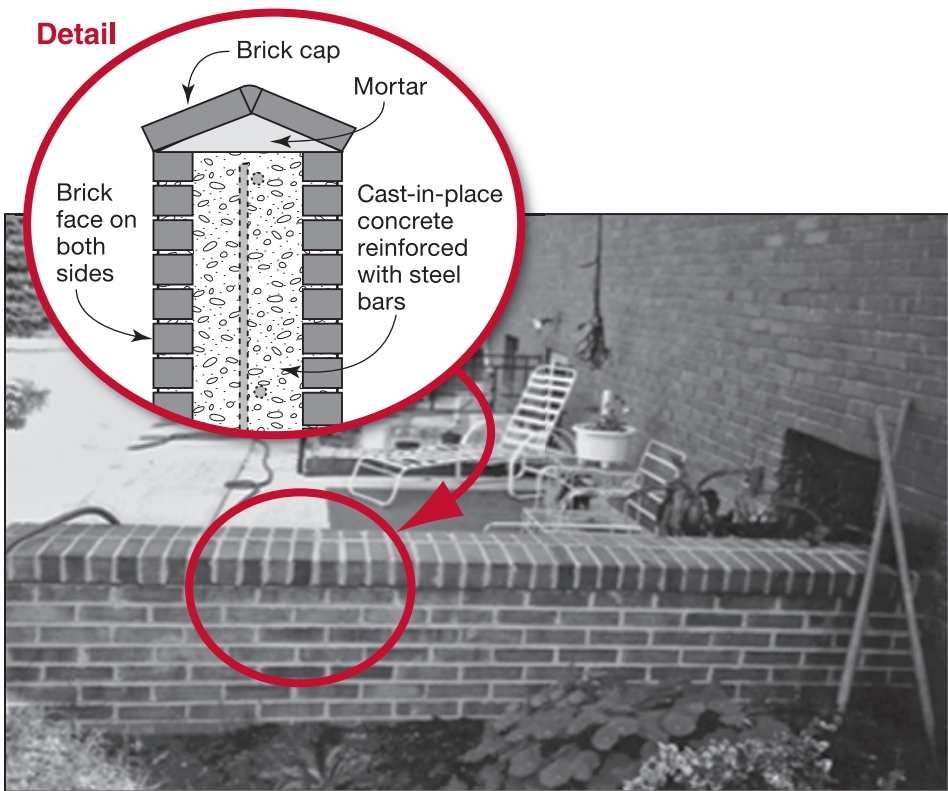

Figure 5F-1. Typical residential floodwall



Figure 5F-2. Typical residential floodwall



Figure 5F-3.  
Gravity and cantilever floodwalls

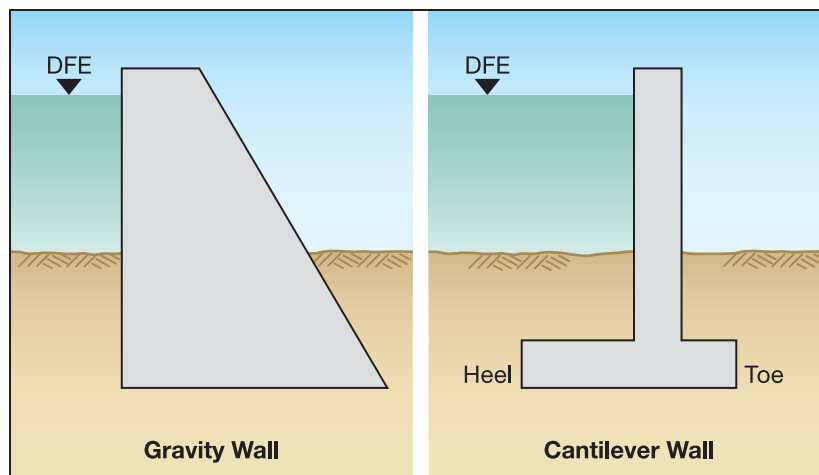
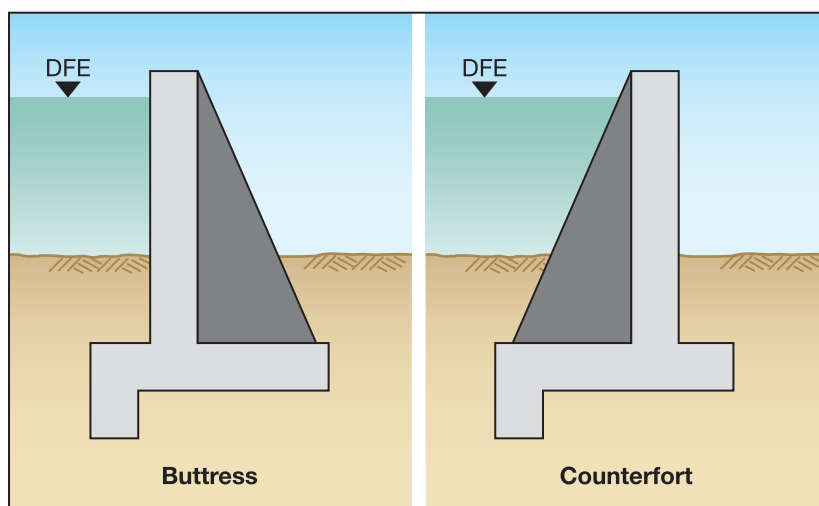

Figure 5F-4.  
Buttress and counterfort floodwalls



### 5F.1.1.2 Cantilever Floodwall

A cantilever wall is a reinforced-concrete wall (cast-in-place or built with concrete block) that utilizes cantilever action to retain the mass behind the wall. Reinforcement of the wall is attained by steel bars embedded within the concrete or block core of the wall (illustrated by Figure 5F-6). Stability of this type of wall is partially achieved from the weight of the soil on the heel portion of the base, as illustrated in Figure 5F-7. The cantilever floodwall is the one most commonly encountered in residential applications.

The floodwall is designed as a cantilever retaining wall, which takes into account buoyancy effects and reduced soil bearing capacity. However, other elements of a floodproofing project (i.e., bracing effects of any slab-on-grade, the crosswalks, and possible concrete stairs) may help in its stability. This results in a slightly conservative design for the floodwall, but provides a comfortable safety factor when considering the



#### NOTE

Reinforced concrete provides an excellent barrier in resisting water seepage, since it is monolithic in nature. The reinforcement not only gives the wall its strength, but limits cracking as well.

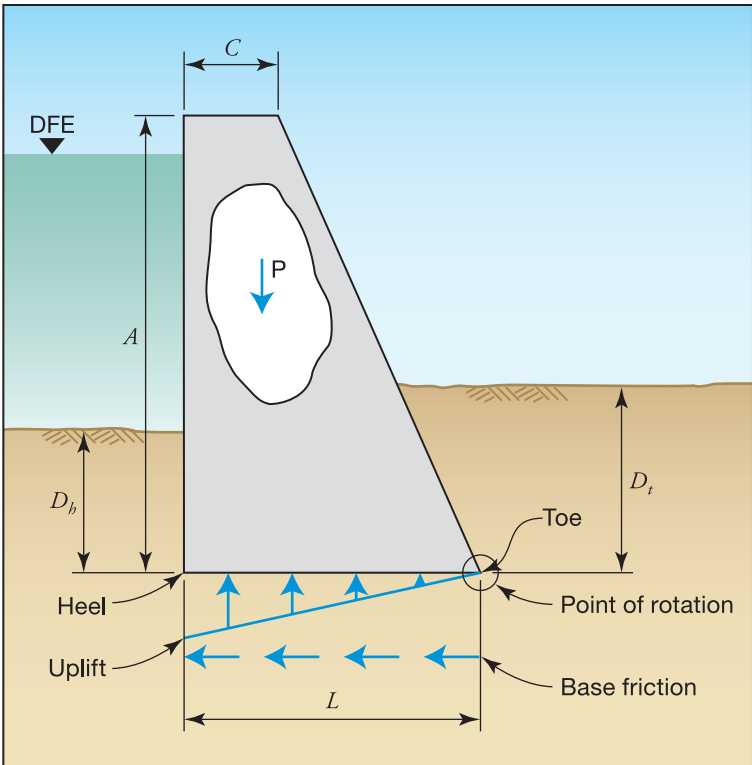

Figure 5F-5. Stability of gravity floodwalls

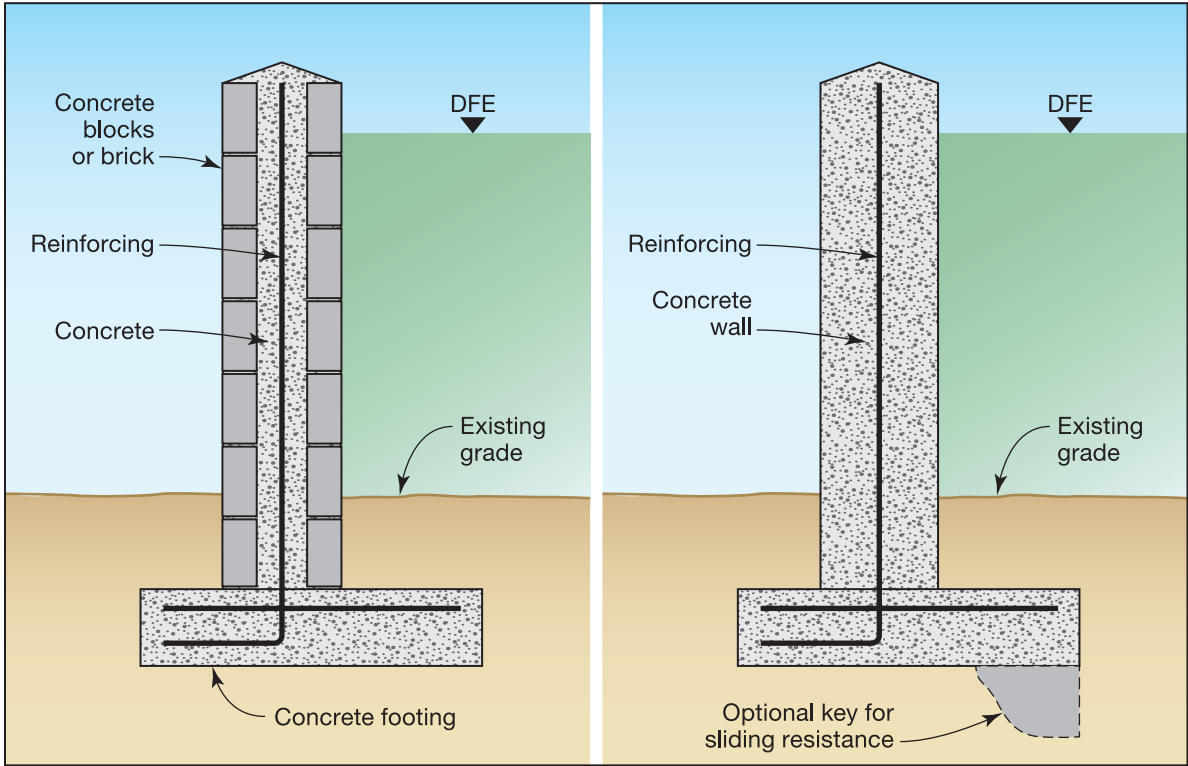
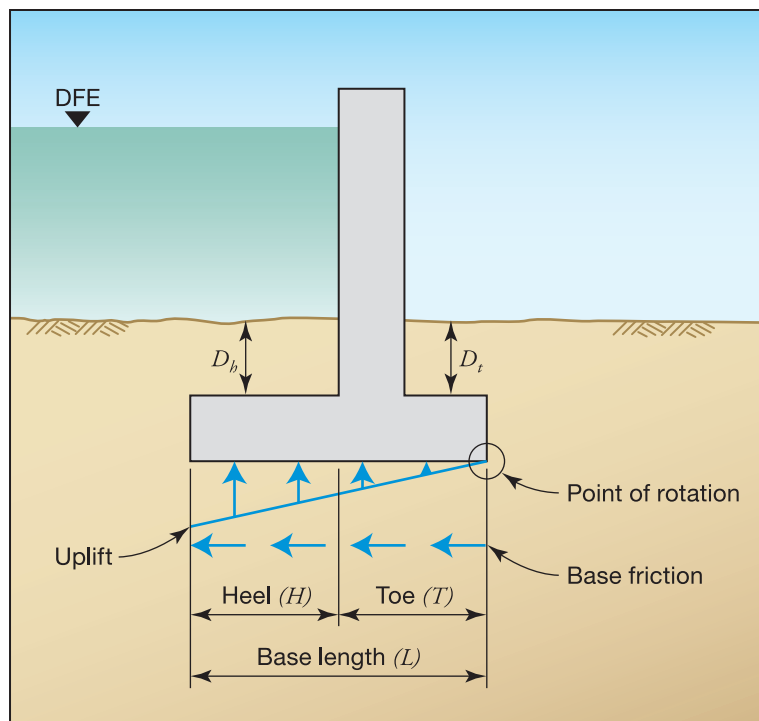

Figure 5F-6. Concrete cantilever floodwall reinforcement

Figure 5F-7.  
Stability of cantilever  
floodwalls



unpredictability of the flood. Backfill can be placed along the outside face of the wall to keep water away from the wall during flooding conditions.

The concrete floodwall may be aesthetically altered with a double-faced brick application on either side of the monolithic cast-in-place reinforced concrete center (illustrated in Figure 5F-1). This reinforced concrete core is the principal structural element of the wall that resists the lateral hydrostatic pressures and transfers the overturning moment to the footing. The brick-faced wall (illustrated in Figure 5F-8) is typically used on homes with brick facades. Thus, the floodwall becomes an attractive modification to the home. In terms of the structure, the brick is considered in the overall weight and stability of the wall and in the computation of the soil pressure at the base of the footing, but is not considered to add flexural strength to the floodwall.



**NOTE**

Information and details for a standard reinforced concrete floodwall are provided in Case Study 1 in Chapter 6.

When the flood protection elevation requirements of a gravity or cantilever wall become excessive in terms of material and cost, alternative types of floodwalls can be examined. The use of these floodwall alternatives is generally determined by the relative costs of construction and materials, and amount of reinforcement required.

**5F.1.1.3 Buttressed Floodwall**

A buttressed wall is very similar to a counterfort wall. The only difference between the two is that the transverse support walls are located on the side of the stem, opposite the retained materials.

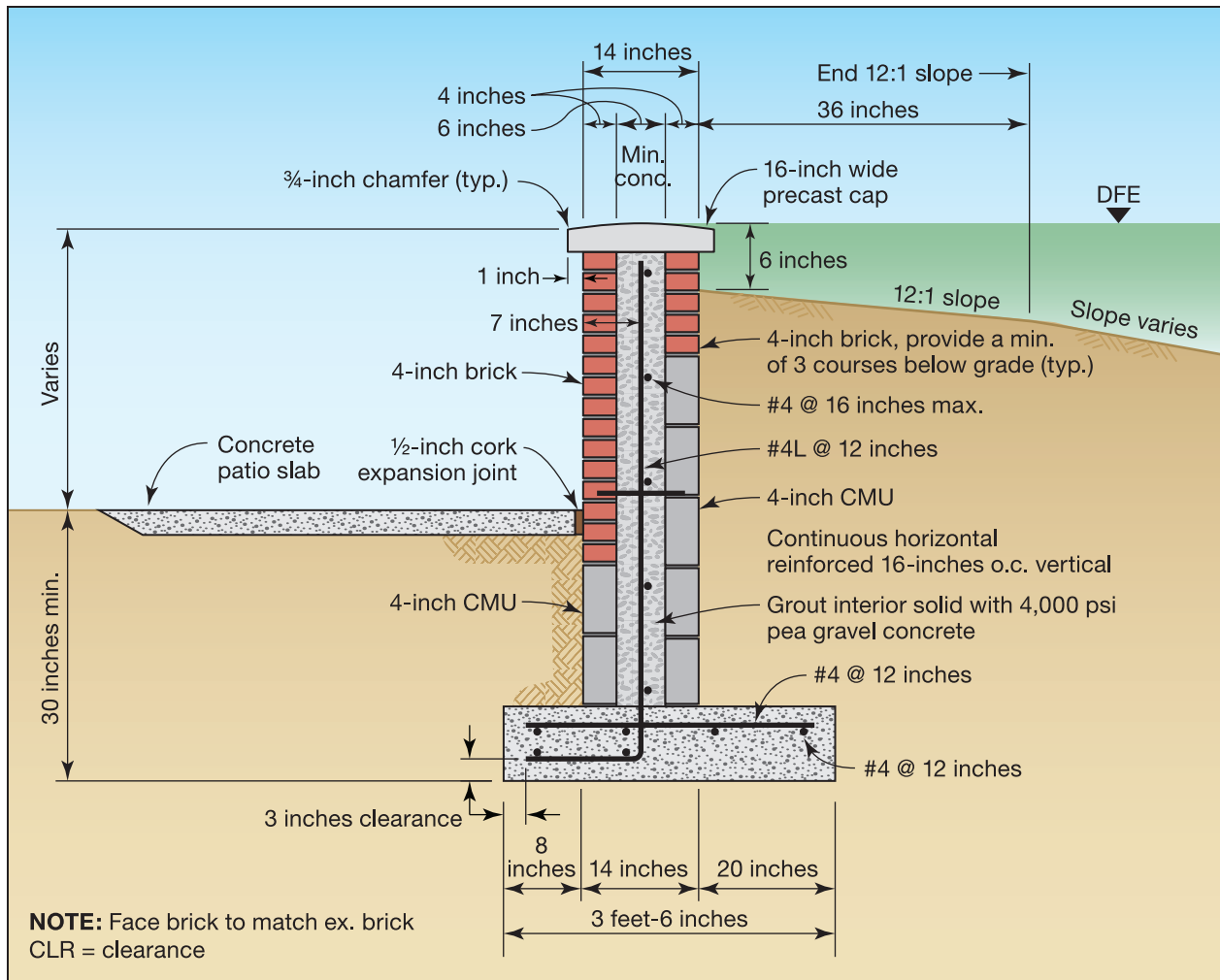

Figure 5F-8. Typical section of a brick-faced concrete floodwall

The counterfort wall is more widely used than the buttress because the support stem is hidden beneath the retained material (soil or water), whereas the buttress occupies what may otherwise be usable space in front of the wall.

### 5F.1.1.4 Counterfort Floodwall

A counterfort wall is similar to a cantilever retaining wall except that it can be used where the cantilever is long or when very high pressures are exerted behind the wall. Counterforts, or intermediate traverse support bracing, are designed and built at intervals along the wall and reduce the design forces.



### WARNING

While the double-faced brick floodwall application is used on either side of concrete block with reinforced and grouted cores, experience has indicated it is not as strong or leak-proof as monolithic cast-in-place applications.

Generally, counterfort walls are economical for wall heights in excess of 20 feet, but are rarely used in residential applications.

### 5F.1.2 Field Investigation for Floodwalls

Detailed information must be obtained about the site and existing structure to make decisions and calculations concerning the design of a floodwall. The designer should utilize the guidance presented in this chapter where detailed information and checklists for field investigation are presented. Key information to collect includes the low point of elevation survey, topographic and utilities surveys, hazard determinations, local building requirements, and homeowner preferences. Once the designer has developed the above-mentioned low point of entry and site and utility survey information, a conceptual design of the proposed floodwall can be discussed with the homeowner. This discussion should cover the following items:

- previous floods and which areas were flooded or affected by floods;
- a plan of action as to which opening(s) and walls of the structure can be protected by a floodwall and floodwall closures;
- evidence of seepage/cracking in foundation walls, which would indicate the need to relieve hydrostatic pressure on the foundation;
- a plan of action to use a floodwall to relieve hydrostatic pressure on the foundation and other exterior walls;
- the various floodwall options and conceptual designs that would provide the necessary flood protection (obtain consensus on the favored type, size, location, and features of the floodwalls);
- a plan of action as to which utilities need to be adjusted or floodproofed as a result of the floodwall; and
- a plan of action for construction activity and access/egress to convey to the owner the level of disruption to be expected.

The designer of a floodwall should be aware that the construction of these measures may not reduce the hydrostatic pressures against the below-grade foundation of the structure in question. Seepage beneath the floodwall and the natural capillarity of the soil layer may result in a water level inside the floodwall that is equal to or above grade. This condition is worsened by increased depth of flooding outside the floodwall and the increased flooding duration. Unless this condition is relieved, the effectiveness of the floodwall may be compromised. This condition is illustrated in Figure 5F-9.

It is important that the designer check the ability of the existing foundation to withstand the saturated soil pressures that would develop under this condition. The computations necessary for this determination are provided in Chapter 4.

The condition can be relieved by installation of foundation drainage (drainage tile and sump pump) at the footing level and/or by extending the distance from the foundation to the floodwall. The seepage pressures can also be decreased by placing backfill against the floodwall to extend the point where



#### NOTE

Determination of an appropriate distance from the structure for the floodwall is a function of the depth of the foundation and the soil type. The deeper the lowest level of the structure, the farther away the floodwall should be placed.

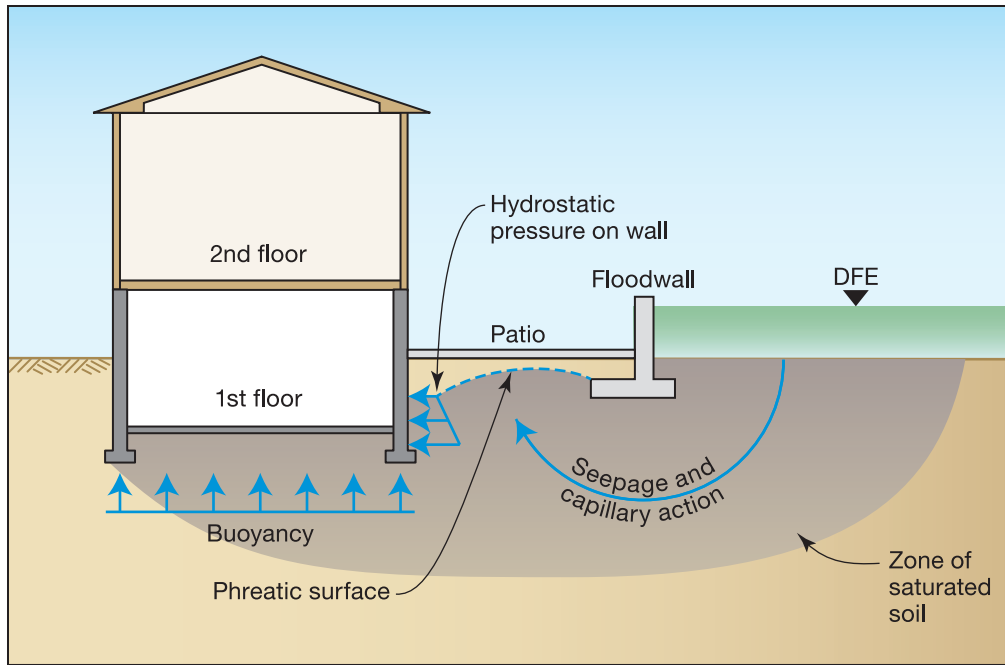

Figure 5F-9. Seepage underneath a floodwall

floodwaters submerge the soil, but the effectiveness of this measure depends on the relative characteristics of the soils in the foundation and the backfill. The design of foundation drains and sump pumps is presented in Section 5D.

Computation of the spacing required to obviate the problem is a complicated process that should be done by an experienced geotechnical engineer. Figure 5F-10 illustrates the change in phreatic surface as a result of increasing the distance between the foundation and the floodwall and/or the installation of a foundation

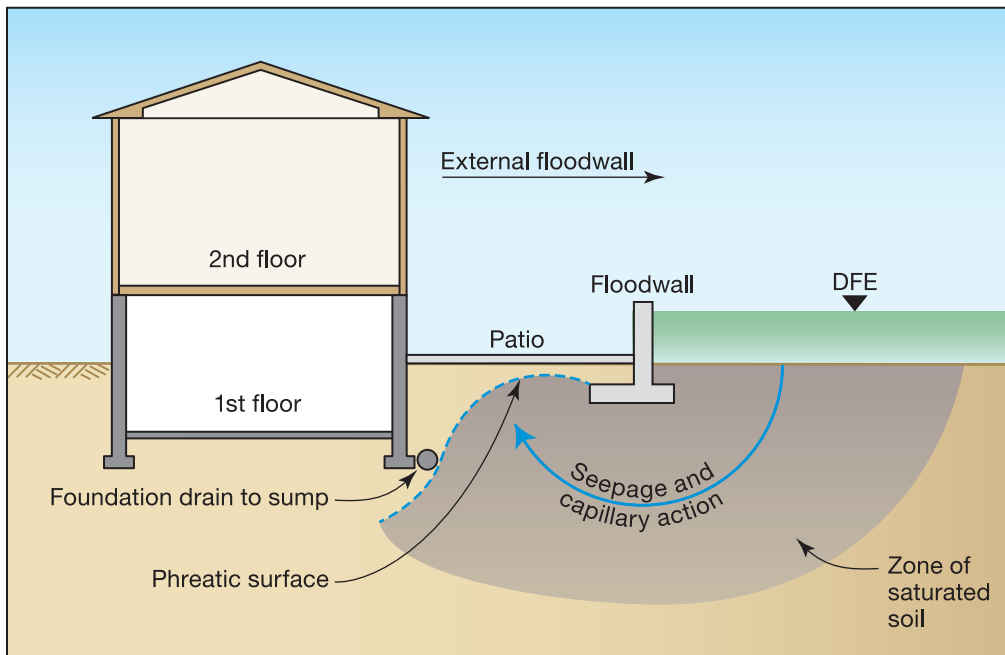

Figure 5F-10. Reducing phreatic surface influence by increasing distance from foundation to floodwall and adding foundation drain

drain and sump pump system. The phreatic surface represents the surface of the water table at or below the ground level.

### 5F.1.3 Floodwall Design

The design of floodwalls consists of the proper selection and sizing of the actual floodwall and the specification of appurtenances such as drainage systems; waterproof materials to stop seepage and leakage; and miscellaneous details to meet site and homeowner preferences for patios, steps, wall facings, and support of other overhead structures (posts and columns). The following sections describe both a detailed design and a simplified design approach.



#### **WARNING**

The permeability of concrete block may necessitate the use of a monolithic core or the application of sealants to eliminate seepage through the wall.

#### 5F.1.3.1 Floodwall Design (Selection and Sizing)

The structural design of a floodwall to resist anticipated flood and flood-related forces follows the eight-step process outlined in Figure 5F-11.

The stability of the floodwall should be investigated for different modes of failure.

**Sliding:** A wall, including its footing, may fail by sliding if the sum of the lateral forces acting upon it is greater than the total forces resisting the displacement. The resisting forces should always be greater than the sliding forces by a factor of safety (see Figure 5F-12).

**Overturning:** Another mode of failure is overturning about the foundation toe. This type of failure may occur if the sum of the overturning moments is greater than the sum of the resisting moments about the toe. The sum of resisting moments should be greater than the sum of the overturning moments by a factor of safety (see Figure 5F-13).

**Excessive Soil Pressure:** Finally, a wall may fail if the pressure under its footing exceeds the allowable soil bearing capacity (see Figure 5F-14).



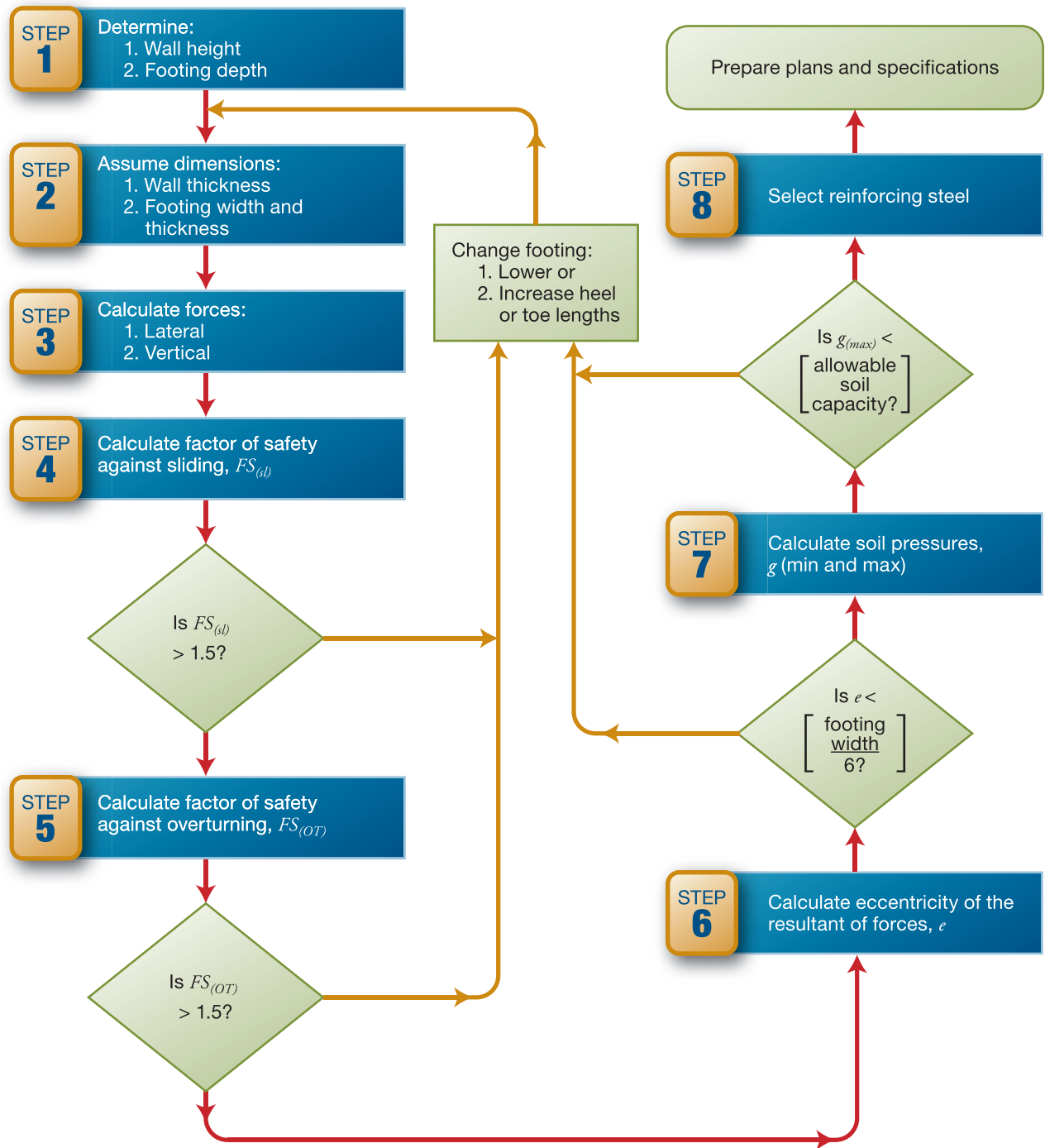

Figure 5F-11. Floodwall design process

Figure 5F-12.  
Failure by sliding

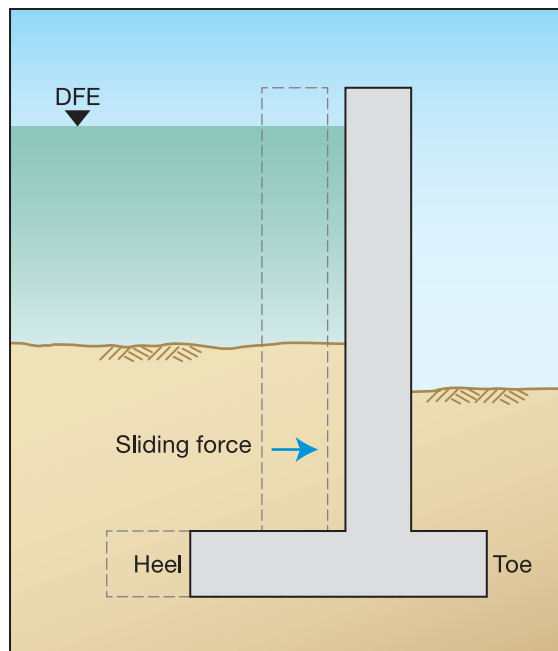
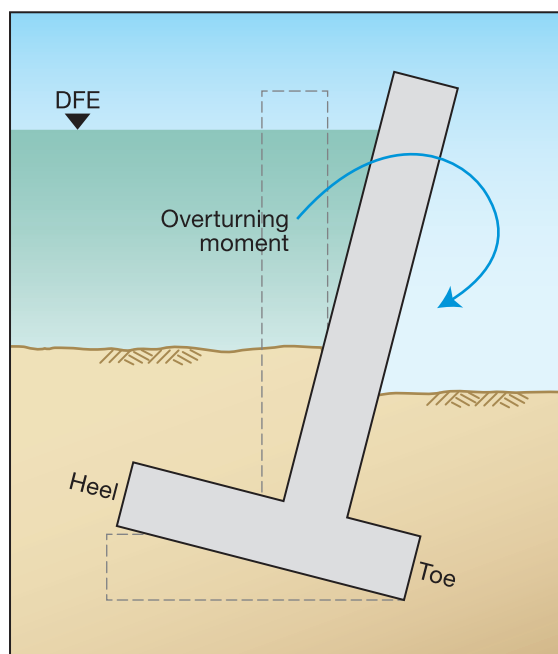

Figure 5F-13.  
Failure by overturning



In the following paragraphs, the step-by-step process for completing the structural design of a floodwall is presented, followed by an example illustrating the use of the equations. Note that the floodwall design process is iterative: an initial design is assumed based on experience and past successful designs, checked against design loads and conditions, then revised as needed until all requirements are satisfied by the design.

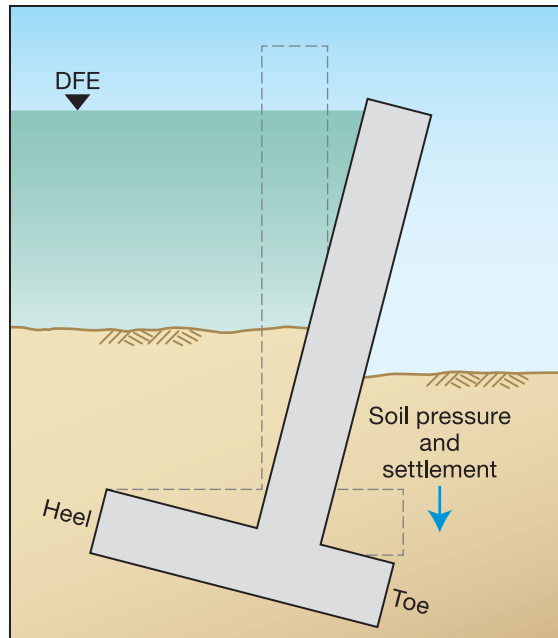

Figure 5F-14. Failure due to excessive soil pressure

Table 5F-1 provides soil information that is necessary in the computations that follow.

Table 5F-1. Soil Factors for Floodwall Design

USCS Soil Type	Allowable Bearing Pressure, $S_{bc}$ (lb/ft <sup>2</sup> )	Coefficient of Friction, $C_f$
Clean, dense sand and gravel, GW, GP, SW, and SP	2,000	0.55
Dirty sand and gravel of restricted permeability, GM, GM-GP, SM, and SM-SP	2,000	0.45
Firm to stiff silts, clays, silty fine sands, clayey sands and gravel, CL, ML, CH, SM, SC, and GC	1,500	0.35
Soft clay, silty clay, and silt, CL, ML, and CH	600	0.30

USCS = United Soil Classification System

**Step 1:** Determine wall height and footing depth.

- a. Determine wall height based on the DFE or BFE plus 1 foot of freeboard, whichever is greater.
- b. Determine minimum footing depth based on the frost depth, local code requirements, and the soil conditions. The footing should rest on suitable natural soil or on controlled and engineered backfill material.

**Step 2:** Assume dimensions.

Based on the following guidelines or reference to engineering handbooks, assume dimensions for the wall thickness, footing width, and footing thickness.

- The choice of wall thickness depends on the wall material, the strength of the material, and the height of the wall. Typical wall thicknesses are 8, 12, and 16 inches for masonry, concrete, or masonry/concrete walls.
- The footing width depends on the magnitude of the lateral forces, allowable soil bearing capacity, dead load, and the wall height. The typical footing width is the proposed wall height. Typically, the footing is located under the wall in such a manner that 1/3 of its width forms the toe and 2/3 of the width forms the heel of the wall as shown in Figure 5F-15. Typical footing thicknesses are based upon strength requirements and include 8, 12, and 16 inches.

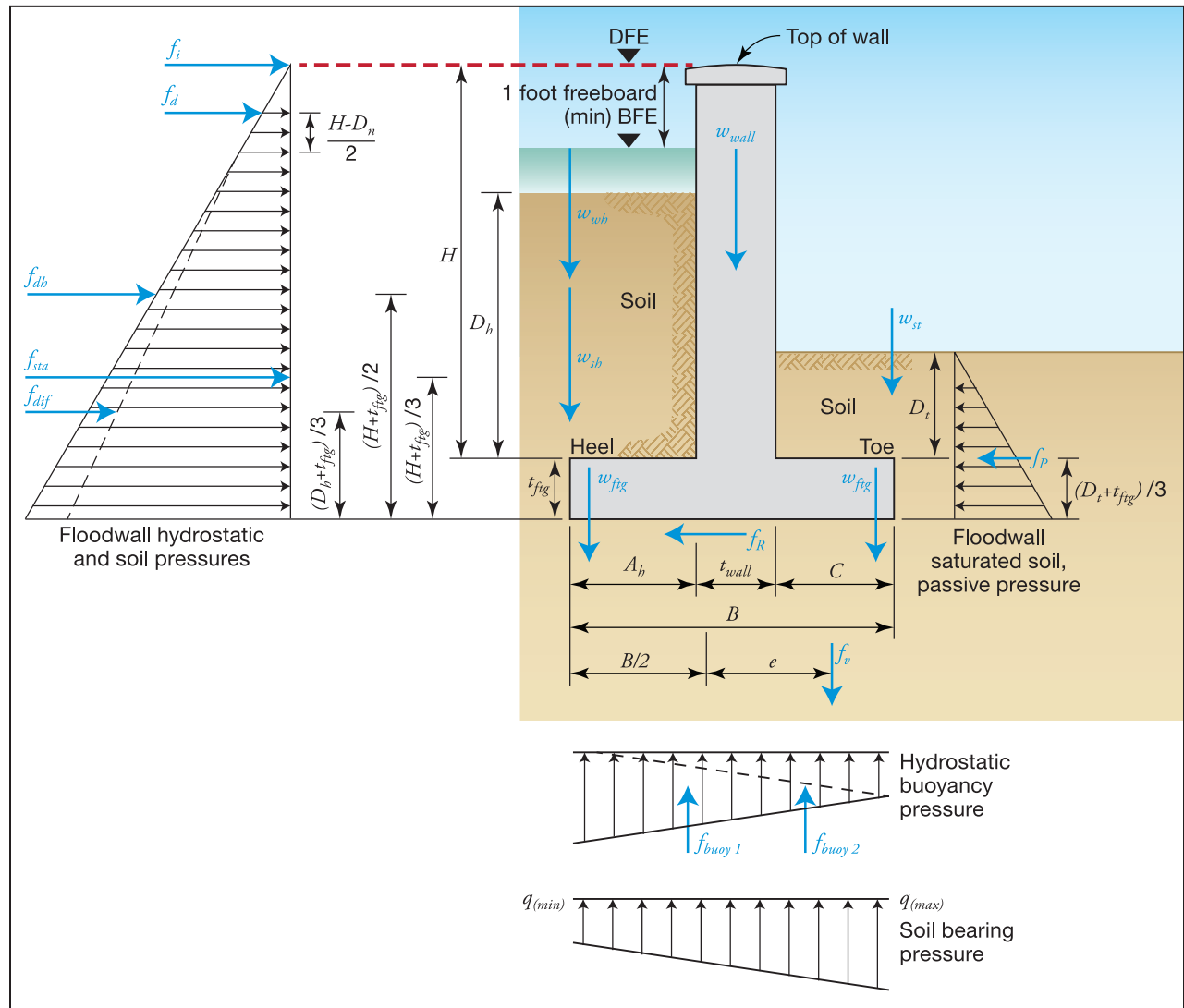

Figure 5F-15. Forces acting on a floodwall

**Step 3:** Calculate forces.

There are two types of forces acting on the wall and its footing: lateral and vertical. These forces were discussed in Chapter 4 and are illustrated in Figure 5F-15.

- Lateral forces:** These forces are mainly the hydrostatic and differential soil/water forces on the heel side of the wall, and the saturated soil force on the toe side of the wall. Hydrostatic and soil forces are as described in Chapter 4.
- Vertical forces:** The vertical forces are buoyancy and the various weights of the wall, footing, soil, and water acting upward and downward on the floodwall. The buoyancy force,  $f_{buoy}$ , acting at the bottom of the footing is computed as follows:

**EQUATION 5F-1: BUOYANCY ON A FLOODWALL**

$$f_{buoy} = f_{buoy1} + f_{buoy2} \quad (\text{Eq. 5F-1})$$

with  $f_{buoy1}$  and  $f_{buoy2}$  computed as follows:

$$f_{buoy1} = \gamma_w \left[ (H) \left( \frac{1}{2} t_{wall} \right) + \left( A_h + \frac{1}{2} t_{rwall} \right) (t_{fig}) \right] \text{ (based on Equation 4-7)}$$

$$f_{buoy2} = \gamma_w \left[ (D_t) \left( \frac{1}{2} t_{wall} \right) + \left( C + \frac{1}{2} t_{rwall} \right) (t_{fig}) \right] \text{ (based on Equation 4-7)}$$

where:

$f_{buoy}$  = total force due to buoyancy (lb/lf)

$f_{buoy1}$  = buoyancy force due to hydrostatic pressure at the floodwall heel acting at an approximate distance of B/3 from the heel (lb/lf)

$f_{buoy2}$  = buoyancy force due to hydrostatic pressure at the floodwall toe, acting at an approximate distance of B/3 from the toe (lb/lf)

$\gamma_w$  = specific weight of water (62.4 lb/ft<sup>3</sup> for fresh water and 64.0 lb/ft<sup>3</sup> for saltwater)

$A_h$  = width of the footing above the heel (ft)

$C$  = width of the footing above the toe (ft)

$H$  = floodproofing design depth (ft)

$D_t$  = depth of soil above the floodwall toe (ft)

$t_{fig}$  = thickness of the floodwall footing (ft)

$t_{wall}$  = thickness of the floodwall (ft)

(Refer to Figure 5F-15)

The gravity forces acting downward are:

- the unit weight of floodwall ( $w_{wall}$ )

**EQUATION 5F-2: FLOODWALL WEIGHT**

$$w_{wall} = (H)t_{wall}S_g \quad (\text{Eq. 5F-2})$$

where:

- $w_{wall}$  = weight of the wall (lb/lf)
- $H$  = floodproofing design depth (ft)
- $t_{wall}$  = wall thickness (ft)
- $S_g$  = unit weight of wall material S (lb/ft<sup>3</sup>)

(Refer to Figure 5F-15)

- the unit weight of the footing ( $w_{ftg}$ )

**EQUATION 5F-3: FOOTING WEIGHT**

$$w_{ftg} = Bt_{ftg}S_g \quad (\text{Eq. 5F-3})$$

where:

- $w_{ftg}$  = weight of the footing (lb/lf)
- $B$  = width of the footing (ft)
- $t_{ftg}$  = footing thickness (ft)
- $S_g$  = unit weight of wall material (concrete is 150 lb/ft<sup>3</sup>)

(Refer to Figure 5F-15)

- the unit weight of the soil over the toe ( $w_{st}$ )



#### EQUATION 5F-4: WEIGHT OF SOIL OVER FLOODWALL TOE

$$w_{st} = C(D_t)(\gamma_{soil}) \quad (\text{Eq. 5F-4})$$

where:

$w_{st}$  = weight of the soil over the toe (lb/lf)

$C$  = width of the footing toe (ft)

$D_t$  = depth of the soil above the floodwall toe (ft)

$\gamma_{soil}$  = unit weight of soil (lb/ft<sup>3</sup>)

(Refer to Figure 5F-15)

#### NOTE

The unit weight of soil,  $\gamma_{soil}$  can be obtained from Chapter 4 or from the soil survey, engineering texts, or a geotechnical engineer.

- the unit weight of the soil over the heel ( $w_{sh}$ )



#### EQUATION 5F-5: WEIGHT OF SOIL OVER FLOODWALL HEEL

$$w_{sh} = A_h(D_h)(\gamma_{soil} - \gamma_w) \quad (\text{Eq. 5F-5})$$

where:

$w_{sh}$  = weight of the soil over the heel (lb/lf)

$A_h$  = width of the footing heel (ft)

$D_h$  = depth of the soil above the heel (ft)

$\gamma_{soil}$  = unit weight of the soil (lb/ft<sup>3</sup>)

$\gamma_w$  = specific weight of water (62.4 lb/ft<sup>3</sup> for fresh water and 64.0 lb/ft<sup>3</sup> for saltwater)

(Refer to Figure 5F-15)



- and the unit weight of the water above the heel ( $w_{wh}$ )



**EQUATION 5F-6: WEIGHT OF WATER ABOVE FLOODWALL HEEL**

$$w_{wh} = A_b(H)(\gamma_w) \tag{Eq. 5F-6}$$

where:

$w_{wh}$  = weight of the water above the heel (lb/lf)

$A_b$  = width of the footing heel (ft)

$H$  = floodproofing design depth (ft)

$\gamma_w$  = specific weight of water (62.4 lb/ft<sup>3</sup> for fresh water and 64.0 lb/ft<sup>3</sup> for saltwater)

(Refer to Figure 5F-15)

The total gravity forces acting downward,  $w_G$ , in pounds per linear foot can be computed as the sum of the individual gravity forces computed in Equations 5F-2 through 5F-6:



**EQUATION 5F-7: TOTAL GRAVITY FORCES PER LINEAR FOOT OF WALL**

$$w_G = w_{wall} + w_{ftg} + w_{st} + w_{sb} + w_{wh} \tag{Eq. 5F-7}$$

where:

$w_G$  = total gravity forces acting downward (lb/ft)

$w_{wall}$  = weight of wall (lb/ft)

$w_{ftg}$  = weight of footing (lb/ft)

$w_{st}$  = weight of soil over the toe (lb/ft)

$w_{sb}$  = weight of soil over the heel (lb/ft)

$w_{wh}$  = weight of water above the heel (lb/lf)

(Refer to Figure 5F-15)

Therefore, the net vertical force,  $f_v$ , is then calculated as:

**EQUATION 5F-8: NET VERTICAL FORCE**

$$f_v = w_G - f_{buoy} \geq 0 \quad (\text{Eq. 5F-8})$$

where:

$f_v$  = net vertical force (lb/lf)

$w_G$  = total gravity forces acting downward (lb/ft)

$f_{buoy}$  = total force due to buoyancy (lb/lf)

(Refer to Figure 5F-15)

The net vertical forces in Equation 5F-14 must be greater than or equal to zero. If the value is determined to be less than zero, the designer should change the footing dimensions, then go back to Step 3 and try again (as illustrated in Figure 5F-11).

**Step 4:** Calculate factor of safety against sliding.

This step involves the computation of the sliding forces, the forces resisting sliding, and the factor of safety against sliding. For a stable condition, the sum of forces resisting sliding should be larger than the sum of the sliding forces.

- a. **Sliding Forces:** The sum of the sliding (lateral hydrostatic, hydrodynamic, and impact) forces,  $f_{comb}$ , is computed as follows:



**EQUATION 5F-9: SLIDING FORCES**

$$f_{comb} = f_{sta} + f_{dif} + (f_{db} \text{ or } f_d) \tag{Eq. 5F-9}$$

where:

$f_{comb}$  = cumulative lateral hydrostatic force acting at a distance  $H/3$  from the point under consideration (lb/lf)

$f_{sta}$  = lateral hydrostatic force due to standing water (lb/lf)

$f_{dif}$  = differential soil/water force acting due to combined free-standing water and saturated soil conditions (lb/ft)

$f_{db}$  = equivalent hydrostatic pressure due to low velocity flood flows (lb/ft)

$f_d$  = hydrodynamic force against the structure due to high velocity flood flows (lb/ft)

Note: The computations of  $f_{sta}$ ,  $f_{dif}$ ,  $f_{db}$ , and  $f_d$ , and are presented in Equations 4-4, 4-5, 4-9, and 4-12. However, for floodwall design,  $H$  used in equations 4-4 and 4-9 is replaced with  $(H + t_{fig})$ , and  $D$  used in equation 4-5 is replaced with  $(D_h + t_{fig})$ , where:

$H$  = floodproofing design depth (ft)

$D_h$  = depth of soil above the floodwall heel (ft)

$t_{fig}$  = thickness of the floodwall footing (ft)

Additionally, the submerged area of the upstream face of the structure ( $A$ ) in Equation 4-12 is replaced with  $H$  to allow the hydrodynamic force  $f_d$  to be expressed in lb/lf instead of lbs.

(Refer to Figure 5F-15)

- b. **Resisting Forces:** The forces resistant to sliding are the frictional force,  $f_{fr}$ , between the bottom of the footing; the cohesion force,  $f_c$ , between the footing and the soil; and the soil and the saturated soil force,  $f_p$ , over the toe of the footing. These resisting forces are computed as follows:
- c. **Frictional Force:** The frictional force,  $f_{fr}$ , between the bottom of the footing and the soil is a function of net vertical force,  $f_v$ , times coefficient of friction,  $C_f$ . The coefficient of friction,  $C_f$ , between the base and the soil depends on the soil properties (see Table 5F-1).



### EQUATION 5F-10: FRICTIONAL FORCE

$$f_{fr} = C_f f_v \quad (\text{Eq. 5F-10})$$

where:

$f_{fr}$  = friction force between the footing and the soil (lb/ft)

$C_f$  = coefficient of friction between the footing and the soil

$f_v$  = net vertical force acting on the footing as was previously presented in Equation 5F-8 (lb/ft)

- d. **Cohesion Force:** The cohesion force between the base and the soil,  $f_c$ , is obtained by multiplying the width of the footing,  $B$ , by the allowable cohesion value of the soil. This allowable cohesion value is usually obtained from a geotechnical analysis of the soil. The cohesion between the footing and the soil may be destroyed or considerably reduced due to contact from water. Due to potentially high variations in the allowable cohesion value of a soil, the cohesion is usually neglected in the calculations; unless the value of cohesion is ascertained by soil tests or other means, it should be taken as zero in the calculations.



### EQUATION 5F-11: COHESION FORCE

$$f_c = C_s B \quad (\text{Eq. 5F-11})$$

where:

$f_c$  = cohesion force between the base and the soil (lb/ft)

$C_s$  = allowable cohesion force between (lb/ft<sup>2</sup>) (usually assumed to be zero)

$B$  = width of the footing (ft)

(Refer to Figure 5F-15)

e. **Saturated Soil Force Over the Toe:** The saturated soil force over the toe,  $f_p$ , is calculated as:



**EQUATION 5F-12: SATURATED SOIL FORCE OVER THE TOE**

$$f_p = \frac{1}{2} [k_p(\gamma_{soil} - \gamma_w) + \gamma_w] (D_t + t_{ftg})^2 \quad (\text{Eq. 5F-12})$$

where:

- $f_p$  = passive saturated soil force over the toe (lb/ft)
- $\gamma_{soil}$  = unit weight of the soil (lb/ft<sup>3</sup>)
- $D_t$  = depth of the soil over the floodwall toe (ft)
- $t_{ftg}$  = thickness of the floodwall footing (ft)
- $k_p$  = passive soil pressure coefficient
- $\gamma_w$  = specific weight of water (62.4 lb/ft<sup>3</sup> for fresh water and 64.0 lb/ft<sup>3</sup> for saltwater)

(Refer to Figure 5F-15)

**NOTE**

The passive soil pressure coefficient,  $k_p$ , typically ranges from 2–5. Typical values are 2 for plastic clays, 3 for clayey silts and poorly graded gravels, and 3–4 for well graded soils. Consult a geotechnical engineer for more precise values.

The sum of the resisting forces to sliding,  $f_R$ , is calculated as the sum of the individual resisting forces to sliding, computed in Equations 5F-10 through 5F-12, as shown below.



**EQUATION 5F-13: SUM OF RESISTING FORCES TO SLIDING**

$$f_R = f_{fr} + f_c + f_p \quad (\text{Eq. 5F-13})$$

where:

- $f_R$  = resisting force to sliding (lb/ft)
- $f_{fr}$  = friction force between the footing and the soil (lb/ft)
- $f_c$  = cohesion force between the base and the soil (lb/ft)
- $f_p$  = passive saturated soil force over the toe (lb/ft)

(Refer to Figure 5F-15)

- f. **Factor of Safety Against Sliding:** For the stability of the wall, the sum of resisting forces to sliding,  $f_R$ , should be larger than the sum of the sliding forces,  $f_{comb}$ . The ratio of  $f_R$  over  $f_{comb}$  is called the Factor of Safety against sliding,  $FS_{(SL)}$ , and is calculated as:



#### EQUATION 5F-14: FACTOR OF SAFETY AGAINST SLIDING

$$FS_{(SL)} = \frac{f_R}{(f_{comb} + f_i)} \geq 1.5 \quad (\text{Eq. 5F-14})$$

where:

$FS_{(SL)}$  = factor of safety against sliding (should be greater than 1.5)

$f_R$  = sum of the forces resisting sliding in (lb/ft)

$f_{comb}$  = sum of the sliding forces (cumulative lateral hydrostatic force) (lb/ft)

$f_i$  = normal impact force (lb/ft)

Note: The  $f_i$  is expressed in lb/ft based on impact the force  $F_i$  (lbs) computed in Equation 4-13 conservatively applied over a unit length of 1 ft.

The factor of safety against sliding in Equation 5F-14 should be at least 1.5. If the factor of safety is determined to be less than 1.5, the designer should lower the footing, increase the amount of fill over the footing, and/or change the footing dimensions, then go back to Step 3 and try again (as illustrated in Figure 5F-11).

**Step 5:** Calculate factor of safety against overturning.

The potential for overturning should be checked about the bottom of the toe (Figure 5F-5). For a stable condition, the sum of resisting moments,  $M_R$ , should be larger than the sum of the overturning moments,  $M_O$ . The ratio of  $M_R$  over  $M_O$  is called the Factor of Safety against overturning,  $FS_{(OT)}$ .

- a. **Overturning Moments:** The overturning moments are due to hydrostatic and hydrodynamic forces, impact loads, saturated soil, and the buoyancy forces acting on the footing. The sum of the overturning moments,  $M_O$ , is calculated as:



**EQUATION 5F-15: SUM OF OVERTURNING MOMENTS**

$$M_O = f_{sta} \left( \frac{(H + t_{fig})}{3} \right) + f_{dif} \left( \frac{(D_h + t_{fig})}{3} \right) + f_{buoy1} \left( \frac{2B}{3} \right) + \left[ f_{dh} \left( \frac{(H + t_{fig})}{2} \right) \text{ or } f_d \left( (H + t_{fig}) - \frac{(D_h + t_{fig})}{2} + (D_h + t_{fig}) \right) \right] + f_i(H + t_{fig}) + f_{buoy2} \left( \frac{B}{3} \right)$$

(Eq. 5F-15)

where:

$M_O$  = sum of the overturning moments (ft-lbs/lf) (Eq. 4-4)

$f_{sta}$  = lateral hydrostatic force due to standing water (lb/lf)

$f_{dif}$  = differential soil/water force acting due to combined free-standing water and saturated soil conditions (lb/lf) (Eq. 4-5)

$f_{buoy1}$  = buoyancy force, in lb/lf, due to hydrostatic pressure at the floodwall heel acting at an approximate distance of  $B/3$  from the heel (Eq. 5F-1)

$f_{buoy2}$  = buoyancy force, in lb/lf, due to hydrostatic pressure at the floodwall toe, acting at an approximate distance of  $B/3$  from the toe (Eq. 5F-1)

$f_{dh}$  = low velocity force (lb/ft) (Eq. 4-9)

$f_d$  = hydrodynamic force (lb/ft) (Eq. 4-12)

$f_i$  = normal impact force (lb/ft) (Eq. 4-13)

$B$  = width of the footing (ft)

$H$  = height of the wall (ft)

$D_h$  = height of the soil above the heel (ft)

$t_{fig}$  = thickness of the floodwall footing (ft)

Note: The computations of  $f_{sta}$ ,  $f_{dif}$ ,  $f_{dh}$ ,  $f_d$ , and  $f_i$  are presented in Equations 4-4, 4-5, 4-9, 4-12, and 4-13. However, for floodwall design,  $H$  used in equations 4-4 and 4-9 should be replaced with  $(H + t_{fig})$ , and  $D$  used in equation 4-5 should be replaced with  $(D_h + t_{fig})$ . Additionally, the  $f_i$  presented in Equation 4-13 is expressed in lb/lf based on impact force  $F_i$  (lbs) conservatively applied over a length of 1 ft.

**NOTE**

When hydrostatic input loads act on the floodwall sections parallel to the flow and the downstream facing wall, Equations 5F-9 and 5F-15 will produce conservative results. Further detailed analysis may result in smaller sections and a corresponding reduction in cost.



- b. Resisting Moments:** The resisting moments are due to all vertical downward forces and the lateral force due to soil over the toe. The sum of resisting moments,  $M_R$ , is calculated as:



**EQUATION 5F-16: SUM OF RESISTING MOMENTS**

$$M_R = w_{wall} \left( C + \frac{t_{wall}}{2} \right) + w_{fg} \left( \frac{B}{2} \right) + w_{st} \left( \frac{C}{2} \right) + w_{sh} \left( B - \frac{A_h}{2} \right) + w_{wh} \left( B - \frac{A_h}{2} \right) + f_p \left( \frac{(D_t + t_{fg})}{3} \right) \quad (\text{Eq. 5F-16})$$

where:

$M_R$  = sum of the resisting moments in (ft-lbs/lf)

$w_{wall}$  = weight of the wall (lb/lf)

$t_{wall}$  = wall thickness (ft)

$t_{fg}$  = footing thickness (ft)

$w_{fg}$  = weight of the footing (lb/lf) (Eq. 5F-3)

$B$  = width of the footing (ft)

$w_{st}$  = weight of the soil over the toe (lb/lf) (Eq. 5F-4)

$C$  = width of the footing toe (ft)

$D_t$  = depth of the soil above the floodwall toe (ft)

$w_{sh}$  = weight of the soil over the heel (lb/lf) (Eq. 5F-5)

$A_h$  = width of the footing heel (ft)

$w_{wh}$  = weight of the water above the heel (lb/lf) (Eq. 5F-6)

$f_p$  = passive saturated soil force over the (lb/lf) (Eq. 5F-12)

- c. Factor of Safety Against Overturning:** As mentioned earlier, for a stable condition, the sum of resisting moments,  $M_R$ , should be larger than the sum of the overturning moments,  $M_O$ , resulting in a factor of safety greater than 1.0. However, the factor of safety against overturning,  $FS_{(OT)}$ , computed in Equation 5F-17 should not be less than 1.5. If  $FS_{(OT)}$  is found to be less than 1.5, the designer should increase the footing dimensions, then go back to Step 3 and try again (see Figure 5F-11).



### EQUATION 5F-17: FACTOR OF SAFETY AGAINST OVERTURNING

$$FS_{(OT)} = \frac{M_R}{M_O} \geq 1.5 \quad (\text{Eq. 5F-17})$$

where:

$FS_{(OT)}$  = factor of safety against overturning (should be greater than 1.5)

$M_R$  = sum of the resisting moments in ft-lbs/lf (Equation 5F-16)

$M_O$  = sum of the overturning moments in ft-lbs/lf (Equation 5F-15)

**Step 6:** Calculate eccentricity.

The final resultant of all the forces acting on the wall and its footing is a force acting at a distance,  $e$ , from the centerline of the footing. This distance,  $e$ , is known as eccentricity. The calculation of eccentricity is important to ensure that the bottom of the footing is not in tension. The eccentricity value is also needed for the calculation of soil pressures in Step 7. The eccentricity,  $e$ , is calculated as:



### EQUATION 5F-18: ECCENTRICITY

$$e = \left( \frac{B}{2} \right) - \left( \frac{(M_R - M_O)}{f_v} \right) \quad (\text{Eq. 5F-18})$$

where:

$e$  = eccentricity (ft)

$B$  = width of the footing (ft)

$f_v$  = net vertical force acting on the footing (lb/ft) (Eq. 5F-8)

$M_O$  = overturning moment (ft-lbs/lf) (Eq. 5F-15)

$M_R$  = resisting moment (ft-lbs/lf) (Eq. 5F-16)

(Refer to Figure 5F-15)

This eccentricity,  $e$ , should be less than 1/6 of the footing width. If  $e$  is found to exceed  $B/6$ , change the footing dimensions, go back to Step 3, and try again (see flow chart for design of floodwall).

**Step 7:** Calculate soil pressures.

The soil pressures,  $q$ , are determined from the following equation.



#### EQUATION 5F-19: SOIL PRESSURE

$$q = \left( \frac{f_v}{B} \right) \left( 1 \pm \left( \frac{6e}{B} \right) \right) \quad (\text{Eq. 5F-19})$$

where:

$q$  = soil pressure created by the forces acting on the wall (lb/ft<sup>2</sup>)

$f_v$  = net vertical force acting on the footing (lb/lf) (Eq. 5F-8)

$B$  = width of the footing (ft)

$e$  = eccentricity (ft) (Eq. 5F-18)

(Refer to Figure 5F-15)

The maximum value of  $q$  should not exceed the allowable soil bearing capacity. The bearing capacity of soil varies with the type of soil, moisture content, temperature, and other soil properties. The allowable values should be determined by a geotechnical engineer. Some conservative allowable bearing values for a few soil types are given in Table 5F-1. If the computed value of  $q$  is more than the allowable soil bearing value, increase the footing size, then go back to Step 3 and try again (see Figure 5F-11).

**Step 8:** Select reinforcing steel.

Select an appropriate reinforcing steel size and spacing to resist the expected bending moment,  $M_b$ . Figure 5F-16 illustrates a typical floodwall reinforcing steel installation. The cross-sectional area of steel reinforcing required can be computed using Equation 5F-20. This equation assumes use of steel with a  $F_y = 60$  ksi.



#### NOTE

The bending moment ( $M_b$ ) for sizing reinforcing steel in the vertical floodwall component is the product of the lateral hydrostatic force ( $F_{sta}$ ) and the distance between the point of force application and the bottom of the vertical floodwall component ( $H/3 - t_{fig}$ ).

**EQUATION 5F-20: CROSS-SECTIONAL AREA OF REINFORCING STEEL**

$$A_s = \left( \frac{\left( \frac{M_b}{1,000} \right)}{1.76d_f} \right) \quad (\text{Eq. 5F-20})$$

where:

- $A_s$  = cross-sectional area of reinforcing steel required per foot width of wall (in.<sup>2</sup>)
- $M_b$  = bending moment (ft-lbs/lf)
- 1,000 = factor used to convert ft-lbs to ft-kips
- $d_f$  = distance between the reinforcing steel and the floodwall face opposite retained material (in.)

(Refer to Figure 5F-16)

**NOTE**

$d_f$  is typically the floodwall thickness minus 3½ inches to allow a minimum of 3 inches between the reinforcing steel and the floodwall edge.

**NOTE**

The selection of reinforcing steel in the footing portion of a floodwall is computed using Equation 5F-20 while modifying  $M_b$  for top and bottom steel considerations. For top steel, the moment is the product of the weight of soil and water over the heel ( $w_{sh} + w_{wb}$ ) and the heel length ( $A_h$ ) divided by 2.

The selection of bottom steel is a function of the soil bearing pressure. The moment can be computed by adding the soil bearing pressure at the toe edge of the vertical floodwall section to twice the maximum soil bearing pressure ( $q + 2q_{max}$ ) and multiplying this sum by toe length squared over 6 ( $C^2/6$ ). The soil bearing pressure at the toe edge of the vertical floodwall section ( $q$ ) can be computed by ratio from the calculations (for  $q_{min}$ ,  $q_{max}$ ) shown in Step 7.

Using the computed cross-sectional area of reinforcing steel, refer to ACI 318 to select the most appropriate steel reinforcing bar size and spacing.

Refer to Appendix C Example C8 for a sample cantilever floodwall design for a residential building that was developed using this approach.

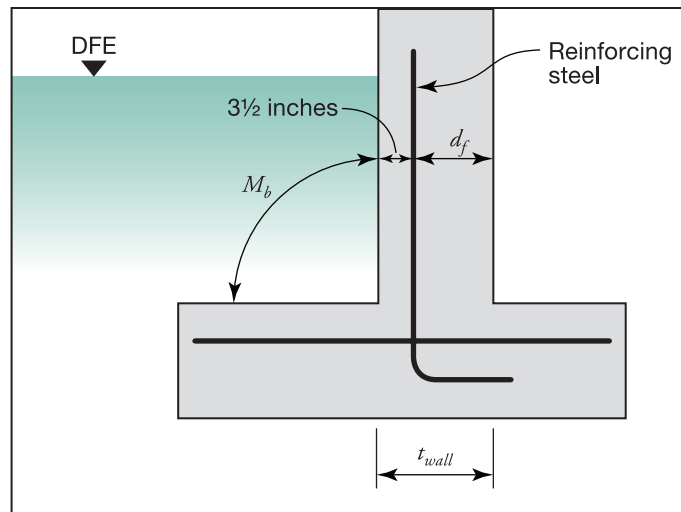

Figure 5F-16:  
Typical floodwall  
reinforcing steel  
configuration

### 5F.1.3.2 Floodwall Design (Simplified Approach)

Table 5F-2 presents general factors used in developing a standardized approach to floodwall design. If the soil conditions at the site in question do not reflect the assumed conditions below, the standard criteria approach cannot be utilized, and the detailed design process presented in Figure 5F-11 must be used.

Based on the stability requirements (assuming no cohesion), footing dimensions for various wall heights, footing depths, and two different soil types have been calculated. The calculation results are shown in Tables 5F-3 and 5F-4. The designer can utilize the following tables to specify floodwall/footing dimensions required for heights up to 7.0 feet, which reflect flooding levels from 1.0 to 4.0 feet (including a minimum of 3 feet of soil over the footing). Flooding levels can be computed as  $(H - D_f)$ . It is important to note that these dimensions are very conservative and the designer may be able to reduce the dimensions.

In these calculations, the following assumptions have been made:

- wall and footing are of concrete;
- wall thickness ( $t_{wall}$ ) = 1.0 foot;
- footing thickness ( $t_{fig}$ ) = 1.0 foot;
- minimal debris impact potential;
- minimal velocity (<5 feet per second); and
- reinforcing consists of #4 steel bars on 12-inch centers in both the wall and footing.



#### NOTE

This simplified approach uses assumed site conditions. The designer should be aware that the previous process is normally used in the design of most floodwalls. However, this design process can be shortened for floodwalls of less than 3 feet in height by assuming certain site-specific soil conditions and design parameters. Tables 5F-3 and 5F-4 show typical floodwall design sizes and reinforcement schemes that would be applicable in certain situations. The designer should be aware that, unless the situation in question meets the assumptions and standard design criteria established herein, it would be prudent to complete the entire design process for the floodwall application.

**Table 5F-2. Assumed Soil Factors for Simplified Floodwall Design**

USCS Soil Type	Allowable Bearing Pressure (lb/ft <sup>2</sup> )	$k_p$ , Passive Soil Pressure Coefficient	$C_\beta$ Friction Factor	Equivalent Fluid Pressure for Saturated Soil	$\gamma_{soil}$ , Unit Weight of Soil, (lb/ft <sup>3</sup> )
Clean, dense sand and gravel, GW, GP, SW, and SP	2,000	3.70	0.55	75	120
Dirty sand and gravel of restricted permeability, GM, GM-GP, SM, and SM-SP	2,000	3.00	0.45	77	115

USCS = United Soil Classification System

**Table 5F-3. Typical Floodwall Dimensions for Clean, Dense Sand and Gravel Soil Types (GW, GP, SW, SP)**

Height of Floodwall* $H$ (ft)	Depth of Soil on Water* Side $D_b$ (ft)	Depth of Soil on Water* Side $D_r$ (ft)	Base Width* $B$ (ft)	Heel Width* $A_r$ (ft)	Toe Width $C$ (ft)
<b>3.0</b>	2.0	2.0	2.6	1.0	0.6
	2.0	2.0	4.6	2.6	1.0
<b>4.0</b>	3.0	2.0	4.0	2.0	1.0
	3.0	3.0	4.6	2.6	1.0
<b>5.0</b>	2.0	2.0	6.6	3.6	2.0
	3.0	2.0	6.0	3.6	1.6
	4.0	2.0	5.6	3.0	1.6
	3.0	3.0	4.6	2.6	1.0
	4.0	3.0	4.0	2.6	0.6
<b>6.0</b>	2.0	2.0	9.0	6.6	1.6
	3.0	3.0	7.0	3.6	2.6
	4.0	3.0	6.6	3.6	2.0
	3.0	2.0	8.0	5.0	2.0
	5.0	2.0	7.0	4.0	1.6
	5.0	3.0	6.0	3.6	1.6

\* See Figure 5F-15

**Table 5F-4. Typical Floodwall Dimensions for Dirty Sand and Gravel of Restricted Permeability Soil Types (GM, GM-GP, SM, SM-SP)**

Height of Floodwall* <i>H</i> (ft)	Depth of Soil on Water* Side <i>D<sub>b</sub></i> (ft)	Depth of Soil on Water* Side <i>D<sub>t</sub></i> (ft)	Base Width* <i>B</i> (ft)	Heel Width* <i>A<sub>t</sub></i> (ft)	Toe Width <i>C</i> (ft)
<b>3.0</b>	2.0	2.0	2.6	1.0	0.6
	2.0	2.0	5.0	2.6	1.0
<b>4.0</b>	3.0	2.0	4.6	2.6	1.0
	3.0	3.0	4.0	2.0	1.0
<b>5.0</b>	2.0	2.0	8.0	5.6	1.6
	3.0	2.0	7.6	5.6	1.0
	4.0	2.0	7.0	5.6	0.6
	3.0	3.0	5.6	3.0	1.6
	4.0	3.0	5.0	3.0	1.6
<b>6.0</b>	3.0	3.0	8.0	5.0	2.0
	4.0	3.0	7.0	4.0	2.0
	5.0	3.0	6.6	4.0	1.5

\* See Figure 5F-15

### 5F.1.4 Floodwall Appurtenances

Floodwall appurtenances include drainage systems, stair details, wall facings, patios, existing structure connections (sealants), existing structure support (posts and columns), and closure details. Each will be discussed with illustrations, details, and photographs provided to help the designer develop details that meet the needs of their specific situation. The designer is reminded that it is likely that a local building code may have standards for the design and construction of many of these items.

#### 5F.1.4.1 Floodwall Closures

In designing floodwall closures, many of the principles discussed earlier in Chapter 5D apply. Watertight closures must be provided for all access openings such as driveways, stairs, and ramps, and seals should be provided for all utility penetrations. Figure 5F-17 illustrates typical floodwall closures. Structural analysis for the design of closures should follow the procedures previously outlined for shield design.

As shown in Figure 5F-18, the type of closure used depends primarily on the size of the opening that needs to be protected. This will determine the type of material to be used and how the closure is to be constructed and operated.

Longer and larger closures, such as for a driveway, must be able to withstand significant flood forces and, therefore, should be made of a substantial material. Normally this would be steel plate, protected against rust and corrosion. Heavy aluminum plate may also be used, although it will likely need to be reinforced. In either case, due to the weight of the closure, is usually best that it be hinged so that it can swing into place. Hinging can be located along the bottom so the closure lies flat when not in use, or it can be placed along one side, so the closure can fold back out of the way.



Figure 5F-17.  
Typical floodwall closures

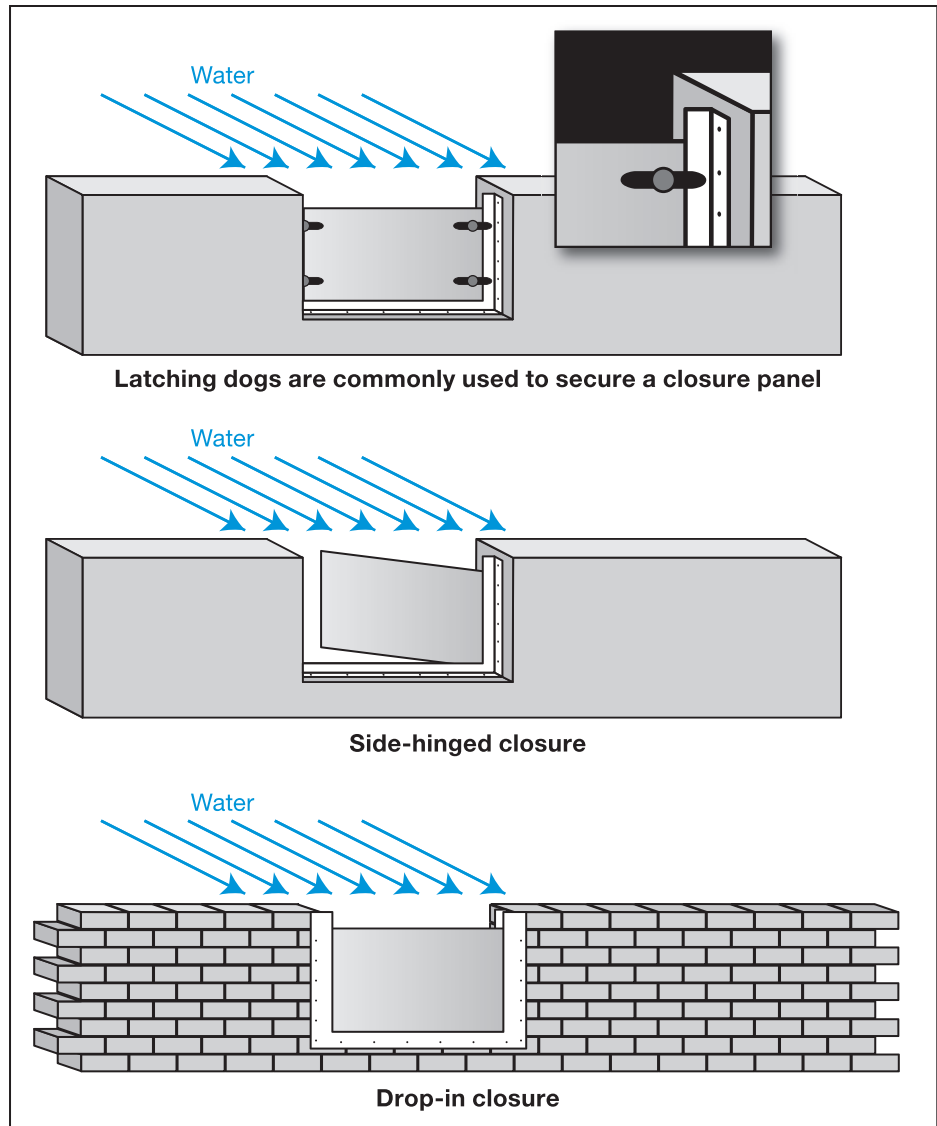
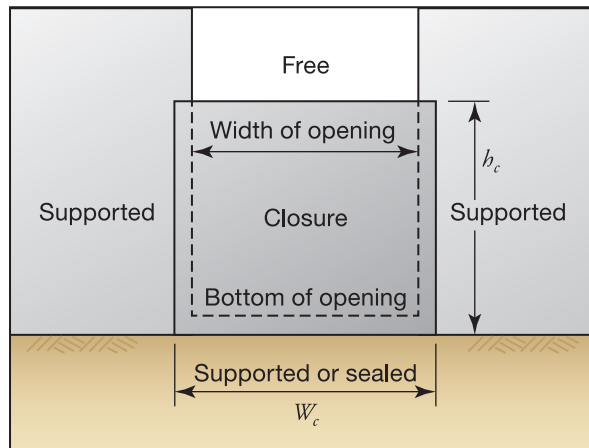

Figure 5F-18.  
Closure variables



For normal passage openings, aluminum is probably the most common material used. It is lightweight, allowing for easy fabrication and transport, and is resistant to corrosion. Aluminum can buckle under heavy water pressure, so it may need some additional reinforcement.

For smaller openings, exterior grade plywood is also commonly used. It is relatively inexpensive and is easily fabricated. However, plywood is subject to warping if not properly stored. In addition, it will collapse under relatively low flood forces, and will usually require significant reinforcement, usually some type of wood frame.

Aluminum and plywood are both light enough to be used for temporary closures that can normally be stored in a safe location and installed only when floodwaters threaten. There are many different arrangements that can be used to install these movable closures. The more common methods include the “drop-in” shield that fits into a special slot arrangement and the “bolt-on” shield that is affixed over an opening. There are several different types of hardware that can be used to secure a closure in place, such as T-bolts, wing nuts on anchored bolts, or latching dogs.

It is absolutely essential that closures be made watertight. This is normally accomplished through the use of some type of gasket. Neoprene and rubber are commonly used, but there are a number of other materials readily available that perform equally as well.

The successful performance of a closure system also requires that it be held firmly against the opening being protected. Although the hydrostatic pressure of the water may help to hold the closure in place, floodwater surges can result in negative pressure that can pull off an improperly installed closure.

Whatever material is used, it must be of sufficient strength and thickness to resist bending and deflection failures. The ability of a specific material to withstand bending stresses may be substantially different from its ability to withstand deflection stresses. Therefore, to provide for an adequate factor of safety, the required closure thickness should be calculated twice: first taking into account bending stresses, and second taking into account deflection stresses. The resulting thicknesses should be compared and the larger value specified in the final closure design.



#### WARNING

**Orientation of Openings:** It is highly recommended that openings in floodwalls and levees **not** be placed on the upstream side. In the event that they are, Equations 5F-21, 5F-22, 5F-23, and 5F-25 should be modified to include the expected hydrodynamic forces. Closures should not be used on upstream sides where impact loads are expected.

One method of determining the thickness of the closure for steel and aluminum is presented in *Roark's Formulas for Stress and Strain* (Roark and Young, 1989). For a flat plate supported on three sides, the plate thickness required due to bending stresses may be determined by the following equation:



**EQUATION 5F-21: PLATE THICKNESS DUE TO BENDING STRESSES**

$$t = \sqrt{\frac{P_b + (P_{db} \text{ or } P_d)W_c^2 \beta}{Max\sigma}} \quad (\text{Eq. 5F-21})$$

where:

- $t$  = plate thickness (in.)
- $P_b$  = hydrostatic pressure due to standing water (psi) from Equation 4-4
- $W_c$  = width of closure (in.)
- $Max\sigma$  = allowable stress for the plate material (from material handbooks) (lb/in.<sup>2</sup>)
- $\beta$  = moment coefficient from Table 5F-5
- $P_{db}$  and  $P_d$  = are defined in Equations 4-9 and 4-11, respectively

(Refer to Figure 5F-18)

Similarly, for a steel or aluminum flat plate supported on three sides, the plate thickness required due to deflection stresses may be determined by the following Equation:



**EQUATION 5F-22: PLATE THICKNESS DUE TO DEFLECTION STRESSES**

$$t = \frac{\sqrt{360\alpha P + (P_{db} \text{ or } P_d)W_c^3}}{E} \quad (\text{Eq. 5F-22})$$

where:

- $\alpha$  = deflection coefficient from Table 5F-5
- $E$  = modulus of elasticity for the plate material (from material handbooks) (lb/in.<sup>2</sup>)
- $P_b$  = hydrostatic pressure due to standing water (psi) from Equation 4-4
- $P_{db}$  and  $P_d$  = are defined in Equations 4-9 and 4-11, respectively

(Refer to Figure 5F-18)

The variables used in the above equations for plate thickness are illustrated in Figure 5F-18. Table 5F-5 details the moment and deflection coefficients as a function of the ratio of plate height to width.

**Table 5F-5. Moment ( $\beta$ ) and Deflection ( $\alpha$ ) Coefficients**

Hc/Wc*	0.05	0.67	1.00	1.50	2.00	2.50	3.00	3.50	4.00
$\alpha$	0.11	0.16	0.20	0.28	0.32	0.35	0.36	0.37	0.37
$\beta$	0.03	0.03	0.04	0.05	0.06	0.06	0.07	0.07	0.07

\* See Figure 5F-18

Allowable values for  $\alpha$  and  $E$  may be found for steel plates in the *Steel Construction Manual* (AISC, 2005), and for aluminum plates in the *Aluminum Construction Manual* (AA, 1959).

The method of designing plywood closure plates is similar to that for steel and aluminum closure plates except that the varying structural properties of plywood make using a single equation inappropriate. Because these structural properties are dependent upon the grades of plywood sheet, the type of glue used, and the direction of stress in relation to the grain, determination of the thickness and grade required for a plywood closure is best achieved by assuming a thickness and grade of plywood and calculating its ability to withstand bending, shear, and deflection stresses. This involves calculating the actual bending, shear, and deflection stresses in the plywood closure plate for the thickness and grade specified. These actual stress values are then compared with the maximum allowable bending, shear, and deflection stresses (taken from *Plywood Design Specifications* [APA, 1997]).



**WARNING**

The designer is referred to *Plywood Design Specifications*, published by the Engineered Wood Association (APA, 1997), for a detailed discussion of design guidelines.

If the actual stresses computed are less than the maximum allowable stresses for bending, shear, and deflection, the thickness and grade specified are acceptable for that application. However, if either of the actual bending or shear stresses or deflection exceeds the maximum allowable values, the closure plate is not acceptable and a new thickness and/or grade of plywood closure plate should be specified and the calculations repeated until all actual stresses are less than the maximum allowed. The following guidance has been prepared to illustrate one method of designing plywood closure plates. Note that a one-way horizontal span is assumed because the variability of plywood properties is dependent upon grain and stress direction.

Compute bending moment on horizontal one-way span (supported on two sides only).



## EQUATION 5F-23: BENDING MOMENT

$$M_b = \frac{[P_b + (P_{db} \text{ or } P_d)]W_c^2}{8} \geq 1.5 \quad (\text{Eq. 5F-23})$$

where:

$M_b$  = bending moment in (in.-lbs/in.);

$P_b$  = hydrostatic pressure due to standing water (psi) from Equation 4-4

$W_c$  = width of the closure (in.)

$P_{db}$  and  $P_d$  = are defined in Equations 4-9 and 4-11, respectively

(Refer to Figure 5F-18)

Check bending stress.



## EQUATION 5F-24: BENDING STRESS

$$f_b = \frac{M_b}{KS} \quad (\text{Eq. 5F-24})$$

where:

$f_b$  = bending stress (lb/in.<sup>2</sup>)

$M_b$  = bending moment (in.-lbs/in.)

$KS$  = effective section modulus from a reference (in.<sup>3</sup>/in.)

If the calculated bending stress for the specified plate ( $f_b$ ) is less than the maximum bending stress allowed ( $F_b$ ) by the plate manufacturer, the closure plate is adequately designed for bending applications. If not, the closure should be redesigned and the calculation repeated.

Compute shear force.



### EQUATION 5F-25: SHEAR FORCE

$$V_s = \frac{[P_b + (P_{db} \text{ or } P_d)]W_c^2}{2} \quad (\text{Eq. 5F-25})$$

where:

$V_s$  = shear force (lbs)

$P_b$  = hydrostatic pressure due to standing water from Equation 4-4 (lb/in.<sup>2</sup>)

$W_c$  = width of the closure plate (in.)

$P_{db}$  and  $P_d$  = are defined in Equations 4-9 and 4-11, respectively

(Refer to Figure 5F-18)

Check shear stress.



### EQUATION 5F-26: SHEAR STRESS

$$F_s = \frac{V_s}{C_{RS}} \quad (\text{Eq. 5F-26})$$

where:

$F_s$  = shear stress (lbs)

$V_s$  = shear force (lbs)

$C_{RS}$  = rolling shear constant dimensionless

If the calculated shear stress for the specified plate ( $F_s$ ) is less than the maximum shear stress allowed ( $F_s$  (allowable)), the closure plate is adequately designed for shear applications. If not, the closure should be redesigned and the calculations repeated.

Compute deflection for a single one-way span.



### EQUATION 5F-27: PLATE DEFLECTION FOR A ONE-WAY SPAN

$$\Delta_b = \frac{[P_b + (P_{db} \text{ or } P_d)](W_c + y)^4}{921.6(E)(I)} \quad (\text{Eq. 5F-27})$$

where:

$\Delta_b$  = computed deflection (in.)

$P_b$  = hydrostatic pressure from Equation 4-4 (lb/in.<sup>2</sup>)

$W_c$  = unsupported width (in.)

$y$  = support width factor (in.)

$E$  = Modulus of Elasticity (lb/in.<sup>2</sup>)

$I$  = Effective Moment of Inertia (in.<sup>4</sup>/ft)

$P_{db}$  and  $P_d$  = are defined in Equations 4-9 and 4-11, respectively

(Refer to Figure 5F-18)

Check deflection.

A customary and acceptable level of deflection may be expressed as:



### EQUATION 5F-28: ALLOWABLE DEFLECTION

$$\Delta_{b \text{ (allowable)}} = \frac{W_c}{240} \quad (\text{Eq. 5F-28})$$

where:

$\Delta_{b \text{ (allowable)}}$  = allowable deflection (in.)

$W_c$  = unsupported width (in.)

(Refer to Figure 5F-18)



If the calculated deflection ( $\Delta_b$ ) is less than the allowable deflection ( $\Delta_{b(allowable)}$ ), the closure plate is adequately designed for deflection situations. If not, the closure should be redesigned and the calculations repeated.

Closure plates of plywood are limited to short spans and low water heights. It should also be noted that most plywood will deteriorate when exposed to high moisture. Therefore, plywood closure plates should be periodically examined and replaced as necessary.

#### 5F.1.4.2 Drainage Systems

When designing a floodwall system, the designer must verify that it will not cause the flooding of adjacent property by blocking normal drainage. Specific information and local requirements can be obtained from the local zoning commission, building inspector, or water control board. Before deciding on a design, the designer should check local building codes, floodplain and/or stormwater management ordinances, zoning ordinances, or property covenants that may prohibit or restrict the type of wall planned.

The flood protection design should be developed to divert both floodwater and normal rainfall away from the structure. By directing the floodwater and rainfall away from the structure, the designer can minimize potential erosion, scour, impacts, and water ponding. Typical design provisions include:

- regrading the site;
- sloping applications; and
- drainage system(s).

Regrading the site basically involves contouring. The surface can be contoured to improve the drainage and minimize floodwater turbulence. Ground covers or grasses, especially those with fibrous root systems, can be effective in holding soil against erosion and scour effects of floodwaters.

Sloping applications include providing a positive drainage for engineered applications such as patios, sidewalks, and driveways. The material is slightly inclined, typically at a 1 percent to 2 percent grade, to an area designed for collection, which includes inlets, ditches, or an existing storm drain pipe system. Figures 5F-19 and 5F-20 show two patio drainage options, and Figure 5F-21 shows a floor drain section typically used to provide positive drainage for patio areas enclosed by floodwalls. These configurations can also be used with sump and sump pump installations.

Drainage systems are a series of pipes that collect and route interior drainage to a designated outfall. Usually the drainage operation is underground and works through a gravity process. However, when grading and sloping will not allow the gravity system to function, provisions for a pumping method, such as a sump pump, should be made. Information on the design of sumps and sump pump applications is provided in Chapter 5D.

For example, in its simplified form, a gutter and downspout outlet, which can be found on almost all houses, is a type of storm drainage system. Provisions at the downspout outfall should also be developed in the site drainage design.

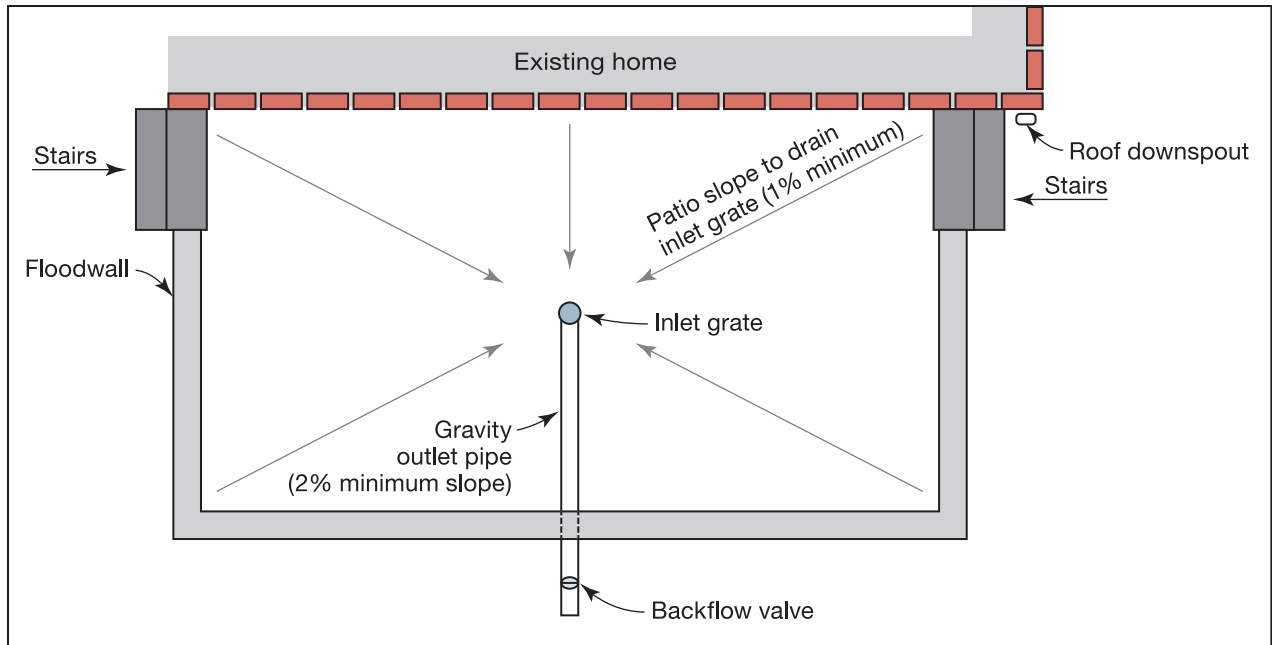

Figure 5F-19. Sample patio drainage to an outlet

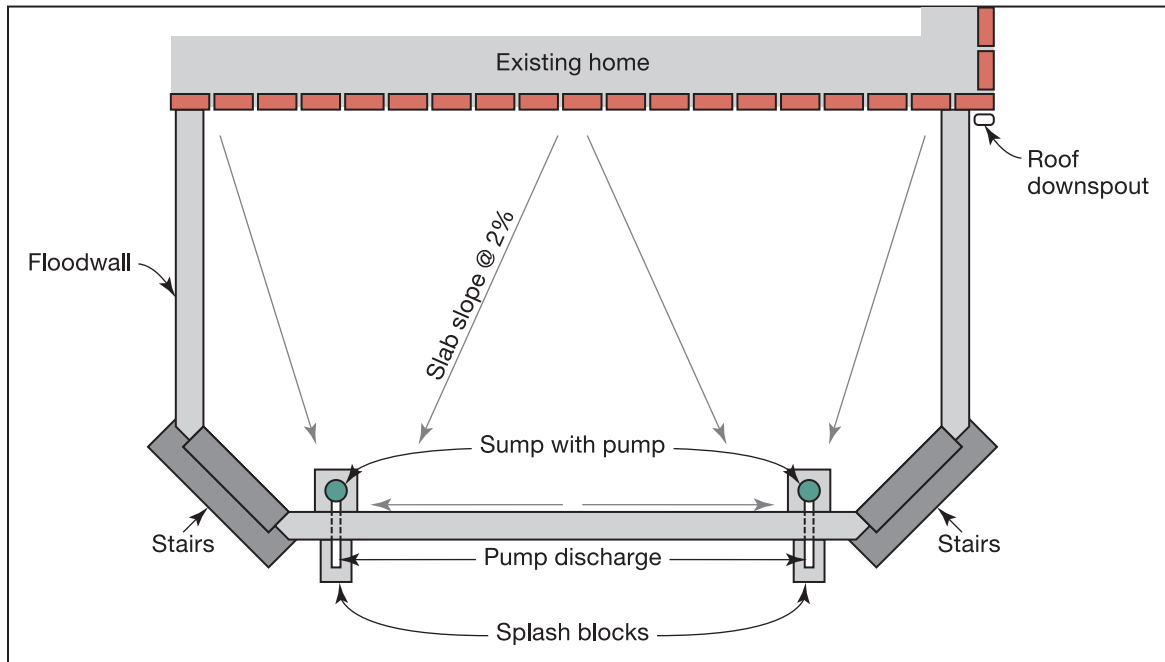

Figure 5F-20. Sample patio drainage to a sump

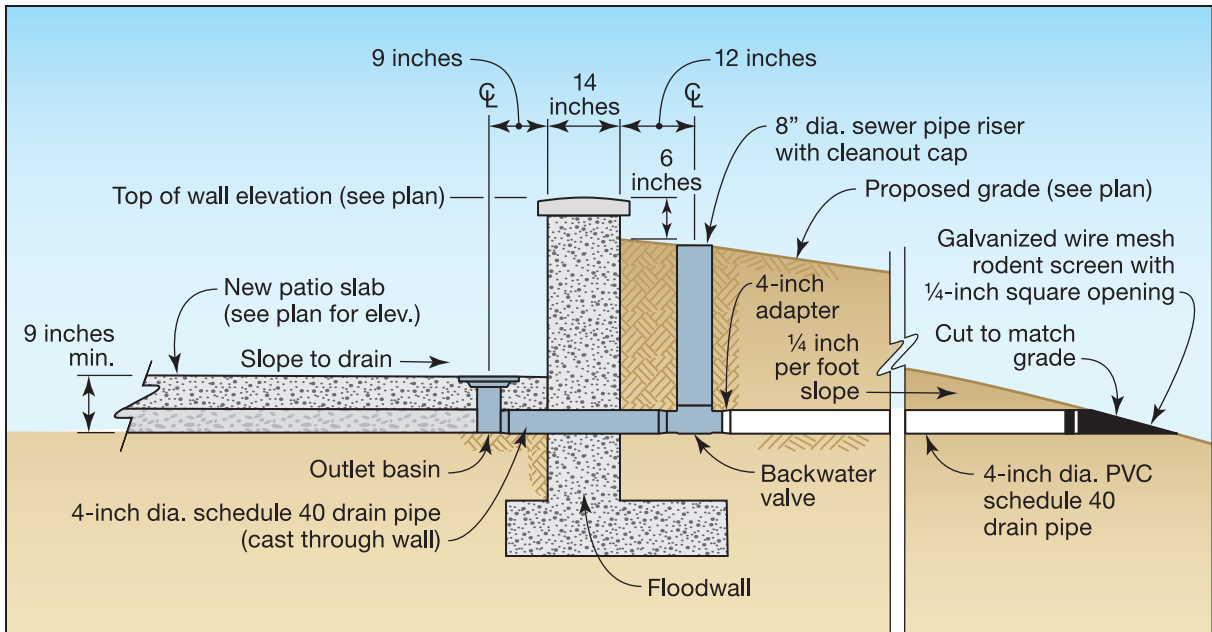

Figure 5F-21. Typical gravity floor drain

Included in the drainage system application is a backflow valve. The unit, sometimes referred to as a check valve, is a type of valve that allows water to flow one way, but automatically closes when water attempts to flow in the opposite direction. Figure 5F-22 shows a typical floodwall with a check valve for gravity drainage. The elevation of the drain outlet should be as high as possible to delay activating the backflow valve, while maintaining a minimum of 2 percent slope on the drain pipe.

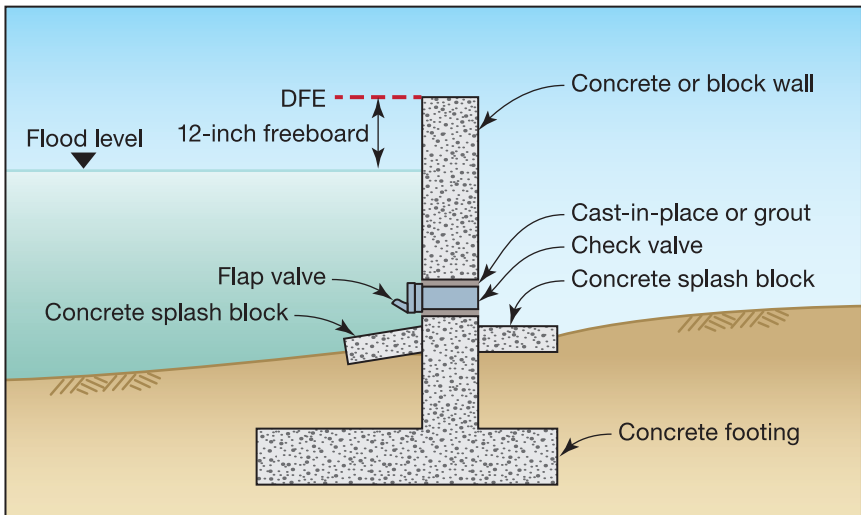

Figure 5F-22. Typical floodwall with check valve

The success of the gravity drainage system is predicated on the fact that the floodwater will reach its maximum height after the rainfall at the site has lessened or stopped. Therefore, when the backflow valve is activated, little or no water will accumulate on the patio slab (usually after the rainstorm). However, should this condition not exist, the use of a sump pump and/or design of runoff storage within the enclosed area should be provided.

### 5F.1.5 Floodwall Seepage and Leakage

Floodwalls should be designed and constructed to minimize seepage and leakage during the design flood. Without proper design considerations, floodwalls are susceptible to seepage through the floodwall, seepage under the floodwall, leakage between the floodwall and residence, and leakage through any opening in the floodwall.

#### 5F.1.5.1 Seepage Through the Floodwall

All expansion and construction joints shall be constructed with appropriate waterstops and joint sealing materials. To prevent excess seepage at the tension zones, the maximum deflection of any structural floor slab or exterior wall shall not exceed  $1/500$  of its shorter span. Figure 5F-23 illustrates the use of waterstops to prevent seepage through a floodwall.

**Figure 5F-23.**  
**Waterstop**

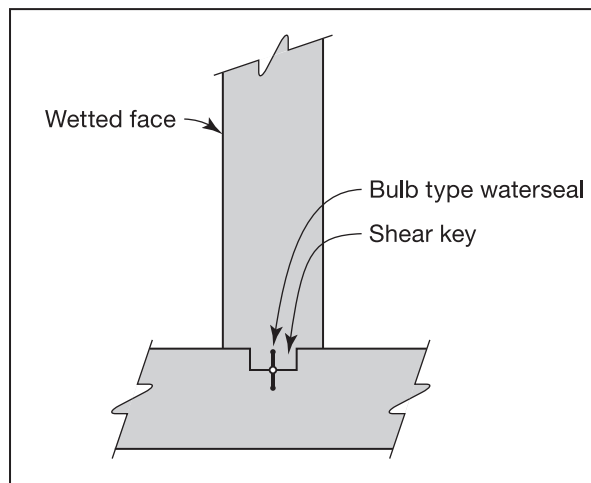

#### 5F.1.5.2 Seepage Under the Floodwall

The structure design may also include the use of impervious barriers or cutoffs under floodwalls to decrease the potential for the development of full hydrostatic pressures and related seepage. These cutoffs must be connected to the impervious membrane of the building walls to effectively operate.

To meet these requirements, it may be necessary to provide impervious cutoffs to prevent seepage beneath the floodwall. This requirement is critical for structures that are designed on highly pervious foundation materials. It may also be necessary to construct a drainage system parallel to the interior base of the floodwall to collect seepage through or under the structure and normal surface runoff from the watershed. All seepage

and storm drainage should be diverted to an appropriate number of sumps or gravity drains, or pumped to the floodwater side of the structure. Normal surface runoff (during non-flood conditions) must also be taken into account in the drainage system.

**5F.1.5.3 Leakage Between the Floodwall and Residence**

The connection between the existing house wall and the floodwall is normally not a fixed connection, because the floodwall footing is not structurally tied to the house foundation footing. Therefore, a gap or expansion joint may exist between the two structures that creates the potential for leakage. This gap should be filled with a waterproof material that will work during seasonal freeze-thaw cycles.



**NOTE**

The effectiveness of house floodproofing can be increased by placing fill against the house to keep floodwaters from coming into direct contact with the structure.

One alternative, illustrated in Figure 5F-24, is to utilize a 1/2-inch bituminous expansion material, 1/2-inch high-density caulking, and a bulb type water seal.

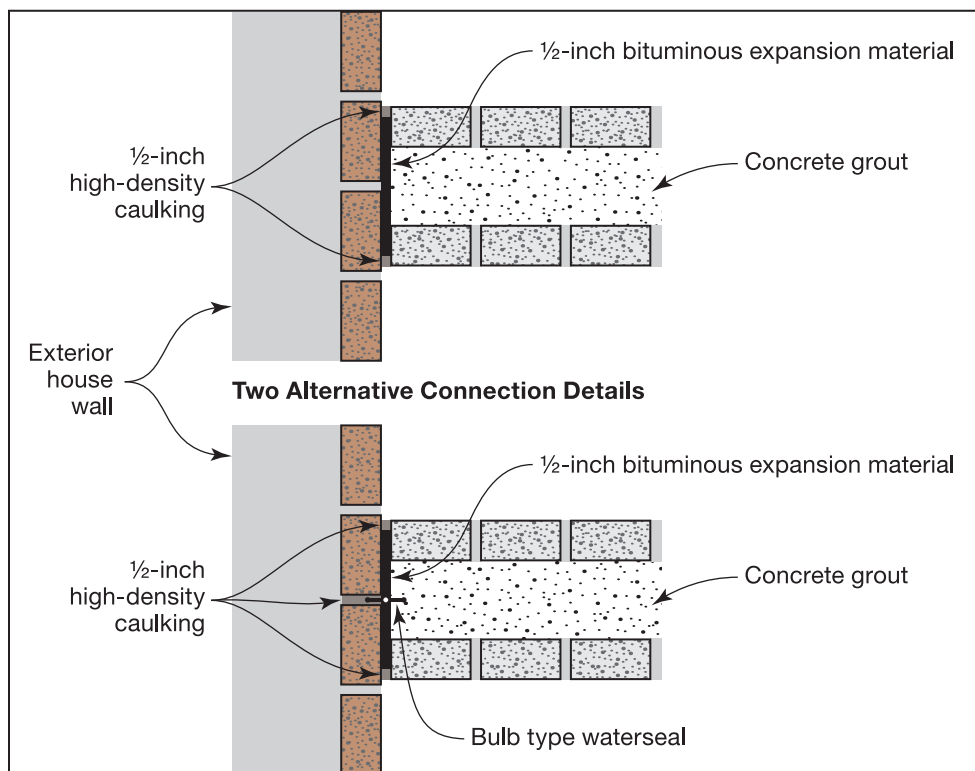

**Figure 5F-24**  
**Floodwall to house connection**

**5F.1.6 Floodwall Architectural Details**

Floodwalls can be constructed in a variety of designs and materials. By taking into account the individual house design, topography, and construction materials, along with some imagination, the designer can build a floodwall to not only provide a level of flood protection, but also enhance the appearance of the house.

The floodwall design can be a challenge to landscape or to blend into the terrain. By using natural topography and employing various types of floodproofing techniques, such as waterproofing, sealants, or decorative bricks or blocks, the designer can make a floodwall not only blend in with the house and landscape, but also make an area more attractive by creating a privacy fence or by outlining a patio or garden area.

The two most common applications of cosmetic facing of a floodwall consist of brick facing and decorative block facing. (This was shown in Figure 5F-1.)

Typical floodwall design often incorporates the use of a patio, which is enclosed by the floodwall. A concrete slab-on-grade or decorative brick paving can be constructed between the house and the floodwall, which will create an attractive and useful feature. The slab-on-grade or brick paving can serve four functional purposes:

- patio area for the homeowner;
- additional bracing for the floodwall;
- positive drainage away from the building towards drainage collection points; and
- impervious barrier inside the floodwall to reduce infiltration of water into the soil adjacent to the structure.

The patio floor or slab-on-grade is set 4 inches below the door openings to provide for a reasonable amount of water storage to accommodate rainfall and roof-gutter spillage that may occur after the floodwaters have reached the elevation that will have closed the backflow valve on the patio drain. The concrete slab is sloped to a floor drain (or drains) which discharge, if existing grade allows, through a gravity pipe or sump pump installation.

In addition to designing patio applications, a qualified design professional can develop architectural and structural modifications that will accommodate existing/future wood decks or roof overhangs (illustrated in Figure 5F-25). These supports can bear on the floodwall's cap, provided additional structural modifications to the floodwall and foundations are furnished to sustain the increased load from above.

**Figure 5F-25.**  
**Floodwall supporting columns**

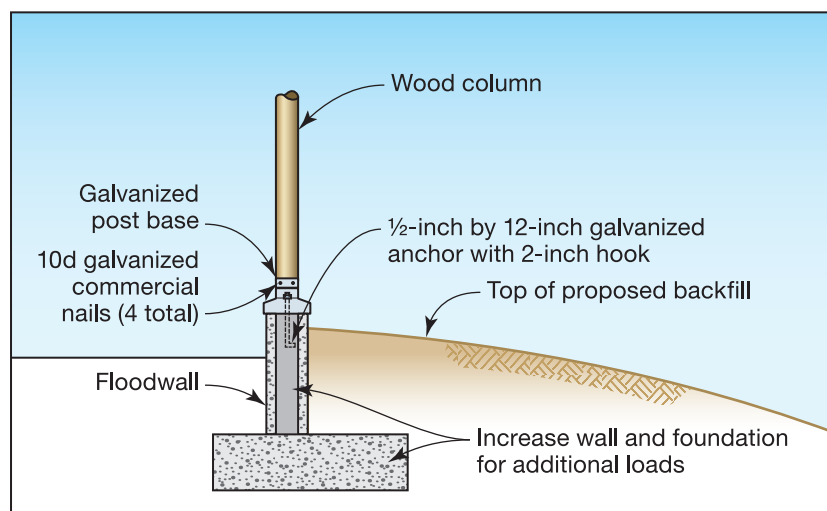

Residential access requirements, such as driveways, sidewalks, doors, and other entrances, will need to be examined during the design. These entrances may create gaps in the floodwall. Every effort should be made to design passages that extend over the top of the wall and not through it. A stile stairway over a floodwall provides access while not creating an opening in the floodwall.

The stile is a series of steps up and over the floodwall and to the designed grades, which thereby closes the floodwall gap and provides permanent flood protection. A typical step detail is shown in Figure 5F-26. Note that handrails, railings, and stair treads and other safety features must be incorporated into the stile stairway in accordance with local building codes.

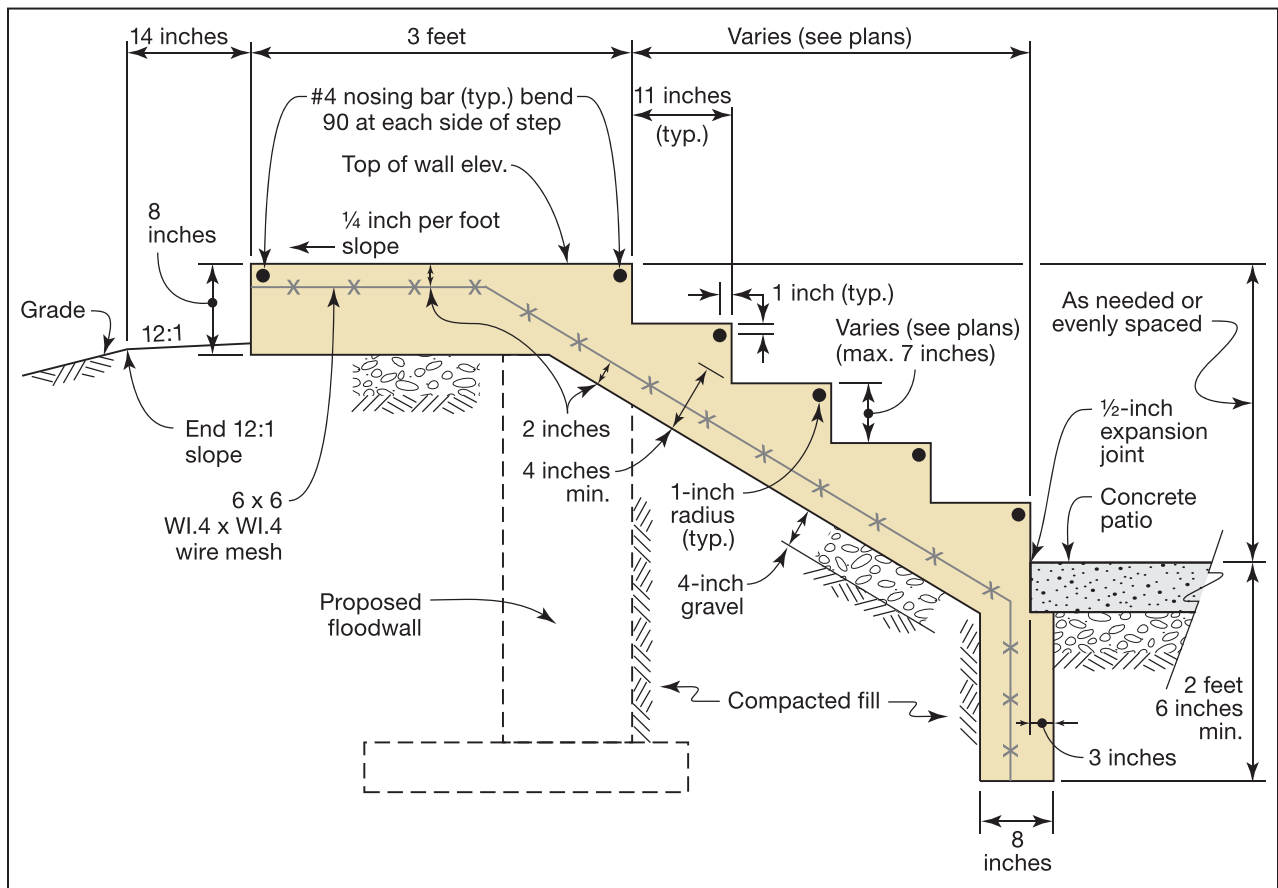

Figure 5F-26. Typical step detail

In addition to the architectural qualities the floodwall can provide, the entire site area can be finished with landscaping features such as planter boxes, trees, and shrubs. Vegetative cover and stone aggregate can also be utilized not only to enhance the flood protection, but also as a method of erosion and scour prevention. A qualified landscape architect should be consulted when selecting material coverage for a particular



**NOTE**

Landscaping inside and hanging over a protected area may generate organic debris that could clog drains. Plants should be selected that do not result in clogged drains from falling leaves or fruit.



area. Roots, foliage, leaves, and even potential growth patterns of certain trees and shrubs should be accounted for in the selection of landscaping materials.

Once the flood protection has been constructed, a maintenance schedule should be adopted to ensure the system will remain operational during flooding conditions. Floodwalls should be inspected annually for structural integrity. The visual investigation should include a checklist and photographic log of:

- date of inspection;
- general floodwall observations involving wall cracking (length, width, locations), deteriorated mortar joints, misalignments, chipping, etc.;
- sealant observation, including displacement, cracking, and leakage;
- overall general characteristics of the site, including water ponding/leakage, drain(s), and drainage and site landscaping;
- operation of the sump pump, generator/battery, and installation of any closures; and
- testing of drains and backflow valves.

Additionally, the entire flood protection system should be inspected after a flood. A complete observation, including a photographic record similar to the annual report, should be developed and may also include:

- damages associated with impacts and flood;
- excessive erosion and scour damage;
- floodwater marks; and
- functional analysis regarding the flood protection system.

The following Floodwall Inspection Worksheet (Figure 5F-27) can be used to record observations during the annual and post-flood inspections.

Floodwall Inspection Worksheet			
Owner Name: _____		Prepared By: _____	
Address: _____		Date: _____	
Property Location: _____			
Floodwall Component	Yes	No	Observations
Cracking in wall			
Mortar joint separation			
Wall misalignment			
Miscellaneous chipping and spalling			
Possible leakage spots			
Sealant displacement			
Water ponding			
Drains functional			
Sump pump operational			
Landscaping			
Sketch area:			
General observations and summary:			

Figure 5F-27. Floodwall Inspection Worksheet

### 5F.1.7 Floodwall Construction

During the construction of a floodwall, periodic inspections should be conducted to ensure that the flood protection measure has been built per the original design intent. As a minimum, the designer, owner, or owner’s representative should inspect and observe the following improvements:

- confirm adequate slope drainage, including drain pipes, patio, and grading outside the floodwall;
- confirm that floodwall foundation was prepared in accordance with plans and specifications;
- confirm that sealants, waterproofing, and caulking were applied per the manufacturer’s requirements for installation;

- confirm that the sump pump is operational;
- check sample brick or decorative block (before installation) for patterns or match to existing conditions; and
- confirm that a maintenance requirement checklist was developed and used that included all of the manufacturer's recommendations for passive flood protection applications, sealants, drains, etc.

## 5F.2 Levees

Unlike floodwalls, levees are not made of manmade materials, but rather compacted soil. Levees are more commonly used than floodwalls for providing protection to individual or limited numbers of residential buildings, but given their relative cost and the amount of land that is required for their construction, they are a less common residential flood-mitigation measure than many of the other retrofitting options presented in this manual. The following sections provide details on important levee design and construction considerations.

### 5F.2.1 Levee Field Investigation

Certain conditions must exist before levees can be considered a viable retrofitting option. The questions that should be asked before proceeding any further are listed below.

- Does the natural topography around the structure in question lend itself to this technique?
- A significant portion of the cost associated with the construction of a levee hinges upon the amount of fill material needed. If the topography around the structure is such that only one or two sides of the structure need to be protected, a levee may be economical.
- Is a suitable impervious fill material readily available?
- Is suitable impervious fill material, such as a CH, CL, or SC, being used? As defined in the ASTM International (ASTM) *Standard Practice for Classification of Soils for Engineering Purposes (Unified Soil Classification System)* Designation D2487-10, (ASTM, 2010), such materials are required to eliminate concerns of seepage and stability.
- Do local, State, or Federal laws, regulations, or ordinances restrict or prevent the construction of a levee?
- Has coordination with local, State, and Federal officials been arranged? This may be necessary to determine if the levee retrofitting option is permissible. Certain criteria prohibit construction within a FEMA-designated floodway, the main portion of a stream or watercourse that conveys flow during a storm.
- Will the construction of a levee alter, impede, or redirect the natural flow of floodwaters?



#### **WARNING**

A settled height of 6 feet is the maximum elevation recommended for individual residential levees.

- Have previous calculations from Chapter 4 to determine both the depth and velocity of flood flows around the structure in question been checked? This should be done to ensure that the levee will not result in increased flood hazards upstream. Also, in many cases, the local floodplain administrator may require an analysis of the proposed modification to the floodplain.
- Will flood velocities allow for the use of this technique?
- Do the flood velocities along the water side of the levee embankment exceed 8 feet per second? If so, the cost of protecting against the scour potential may become so great that a different retrofitting technique should be considered.

**WARNING**

If the assumptions listed in this chapter are not applicable to the site being considered, an experienced levee designer should be consulted or another method considered.

The designer of a levee should be aware that the construction of a levee may not reduce the hydrostatic pressures against a below-grade foundation. Seepage underneath a levee and the natural capillarity of the soil layer may result in a water level inside the levee that is equal to or above grade. This condition is worsened by increased depth of flooding outside the levee and increased flooding duration. Unless this condition is relieved, the effectiveness of the levee may be compromised. This condition, which involves the intersection of the phreatic line with the foundation, is illustrated in Figures 5F-9 and 5F-10.

It is important that the designer check the ability of the existing foundation to withstand the saturated soil pressures that would develop under this condition. The computations necessary for this determination are provided in Chapter 4.

The condition can be relieved by installation of foundation drainage (drainage tile and sump pump) at the footing level, and/or by extending the distance from the foundation to the levee. The land side seepage pressures can also be decreased by placing backfill against the flood side of the levee to extend the point where floodwaters submerge the soil away from the structure, but the effectiveness of this measure depends on the relative characteristics of the soils investigation. The design of foundation drains and sump pumps is presented in Chapter 5D. An experienced geotechnical engineer should compute the spacing required to obviate the problem.

## 5F.2.2 Levee Design

The following sections describe criteria and key steps that are part of the levee design process.

### 5F.2.2.1 Standard Levee Design Criteria

The following parameters are established to provide a conservative design while eliminating several steps in the USACE design process, thereby minimizing the design cost. These guidelines pertain to the design and construction of localized levees with a maximum settled height of 6 feet. Techniques of slope stability analysis and calculation of seepage forces are not addressed. The recommended side slopes have been selected based on experience, to satisfy requirements for stability, seepage control, and maintenance. The shear strength of suitable impervious soils compacted to at least 95 percent of the Standard Laboratory density as determined by ASTM Standard D698-07e1 (ASTM, 2007) will be adequate to ensure stability of such low levees, without the need for laboratory or field testing or calculation of safety factors.

The minimum requirements for crest width and levee side slopes are defined below. In combination with the toe drainage trench (see Section 5F.2.3) and the cutoff effect provided by the backfilling of the inspection trench, these minimum requirements will provide sufficient control of seepage, and do not require complex analyses. Flatter land side slopes are recommended for a levee on a sand foundation to provide a lower seepage gradient because a sand foundation is more susceptible to seepage failure than a clay foundation.

**Maximum Settled Levee Height of 6 Feet:** This is a practical limit placed due to available space and material costs.

**Minimum Levee Crest Width of 5 Feet:** This is required to minimize seepage concerns and allow for ease of construction and maintenance.

**Levee Floodwater Side Slope of 1 Vertical on 2.5 Horizontal:** This is required to minimize the erosion and scour potential, provide adequate stability under all conditions (including rapid drawdown situations), and facilitate maintenance.

**Levee Land Side Slope:** The land side slope may vary, based on the soil type used in the levee. If the levee material is clay, a land side slope of one vertical to three horizontal is acceptable. If the levee material is sand, a flatter slope of one vertical to five horizontal is recommended to provide a lower seepage gradient.

**One Foot of Levee Freeboard:** This is required to provide a margin of safety against overtopping and allow for the effects of wave and wind action. These forces create an additional threat by raising the height of the floodwaters.



#### NOTE

These levee design recommendations—as illustrated in Figure 5F-28 for a typical residential levee—are conservative. Alternative parameters for a specific site may be developed by an engineer qualified in levee design.

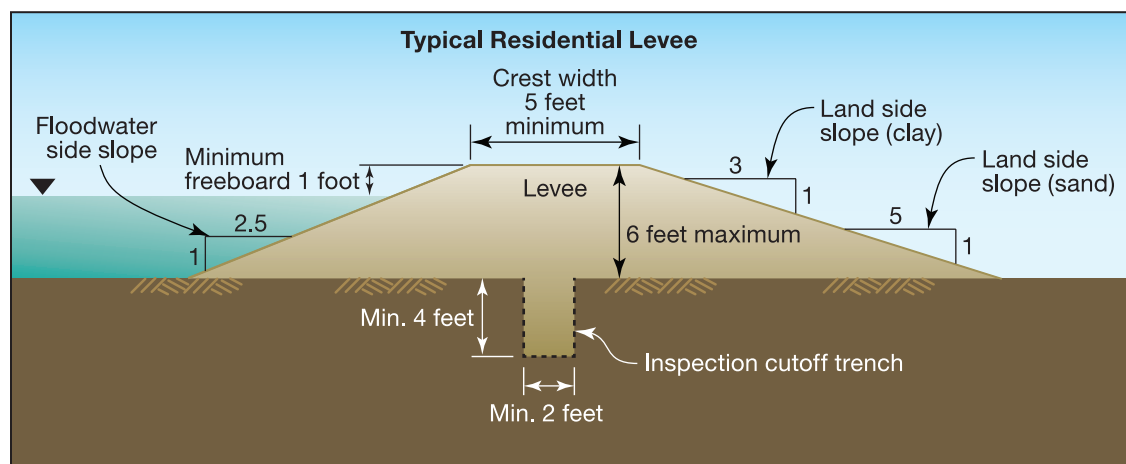

Figure 5F-28. Typical residential levee

### 5F.2.2.2 Initial Levee Design Phases

Because of the importance of the characteristics of the soil that makes up the levee foundation, the excavation of an inspection trench is required. The minimum dimensions of the inspection trench are shown in Figure 5F-28. The inspection trench, which shall run the length of and be located beneath the center of the levee, provides the designer with information that will dictate the subsequent steps in the design process. The mandatory requirement of an inspection trench is fundamental to the assumptions made for the rest of the design process. The inspection trench will accomplish the following objectives:

**Locate Utility Lines That Cross Under the Levee:** Once identified, these must be further excavated and backfilled with a compacted impervious material to prevent development of a seepage path beneath the levee along the lines.

**Provide “Cut-Off” for Levee Foundation Seepage:** The trench itself will be backfilled with a highly impervious soil, such as a CH, CL, or SC, as previously referenced, to create an additional buffer against levee foundation seepage.

**Identify Levee Foundation Soil Type:** The construction of the inspection trench should provide the designer with a suitable sample to identify the foundation soil type through the use of the ASTM Unified Soil Classification System (USCS). This variable will further direct the design of the levee.

- **Clay Foundation:** If, after inspection, it is determined that the in situ foundation material is composed of a clay soil, as defined by the NRCS, a land side slope of 1 vertical on 3 horizontal should be utilized.
- **Sandy Foundation:** If, after inspection, it is determined that the in situ foundation is composed of a sandy soil, as defined by the NRCS, a land side slope of 1 vertical on 5 horizontal should be utilized.



#### WARNING

Duration of flooding is a critical consideration in the design of levee seepage control measures. The longer the duration of flooding (i.e., the longer floodwaters are in contact with the levee), the greater the potential for seepage, and the greater the need for seepage control measures such as cutoffs, drainage toes, and impervious cores.

### 5F.2.3 Levee Seepage Concerns

Two types of seepage must be considered in the design of a residential levee system: levee foundation seepage and embankment seepage. The amount of seepage will be directly related to the type and density of soils in both the foundation and the embankment of the levee. While the installation and backfilling of the inspection trench with impervious material will help reduce concerns of foundation seepage, further steps must be taken to minimize any embankment seepage for levees between 3 and 6 feet in height. The mandatory inclusion of a drainage toe will control the exit of embankment seepage while also controlling seepage in shallow foundation layers.



#### WARNING

If inspection determines that the foundation consists of a deep deposit of sand or gravel that will permit seepage under the shallow inspection trench, a deeper trench would be required, especially if the protected structure has a basement founded in a NRCS-defined sand or gravel. This scenario may make the use of a levee uneconomical.

The inclusion of a drainage toe for a levee of varying height will be limited to those areas with a height greater than 3 feet. If the levee height varies due to the natural topography, a drainage toe will be required only for those portions of the levee that have a height greater than 3 feet.

The major reason for the inclusion of these measures is to relieve the pressure of seepage through or under the levee so that piping may be avoided. Piping is the creation of a flowpath for water through or under a soil structure such as a levee, dam, or other embankment, resulting in a pipe-like channel carrying water through or under the structure. Piping can lead to levee failure. Piping becomes a more serious problem as the permeability of the foundation soil increases.

The drainage toe should be sized as shown in Figure 5F-29, and should be filled with sand conforming to the gradation of standard concrete sand as defined by ASTM standards.

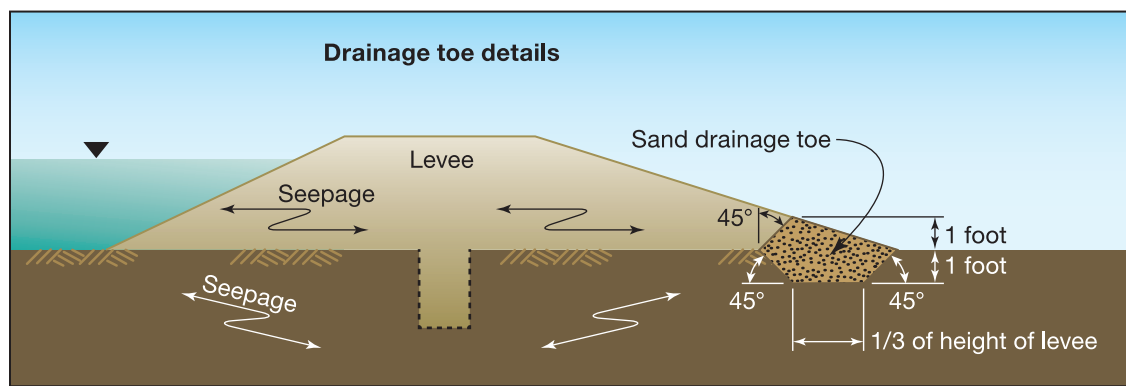

Figure 5F-29. Drainage toe details

**5F.2.3.1 Scouring/Levee Slope Protection**

The floodwater side of the levee embankment may require protection from erosion caused by excessive flow velocities. For flow velocities of up to 3 feet per second, a vegetatively stabilized or sodded embankment will generally provide adequate erosion protection. Some vegetative covers, such as Bermuda grass, Kentucky bluegrass, and tall fescue, provide erosion protection from velocities of up to 5 feet per second. The grasses should be those that are suitable for the local climate. An alternative or supplement to a vegetative cover is the use of a stone protection layer. The layer should be placed on the entire floodwater face of the levee and be sized in accordance with Table 5F-6.



**NOTE**

Long duration flooding may negatively impact the ability of the drainage toe and inspection trench to control the seepage through and under the levee.

Table 5F-6. Stone Protection Layer Guidance

Velocities Against Slope (ft/sec)	Minimum Diameter of Stone (in.)
< 2	0.5
< 5	2.0
< 8	9.0

SOURCE: DESIGN AND CONSTRUCTION OF LEVEES (USACE, 2000)



5F.2.3.2 Interior Levee Drainage

Constructing a levee around a house will not only keep floodwaters out, but also will act to keep seepage and rainfall inside the levee unless interior drainage techniques are utilized. One method of draining water that collects from rain and from seepage through and under a levee is to install drain pipes that extend through the levee, as shown in Figure 5F-30. While this will allow for drainage by gravity, the drains must be equipped with flap gates, which close to prevent flow of floodwaters through the pipe. The flap gates will open automatically when interior floodwaters rise above exterior floodwaters.



**NOTE**

Guidance on estimating interior drainage quantities is presented in Chapter 4.

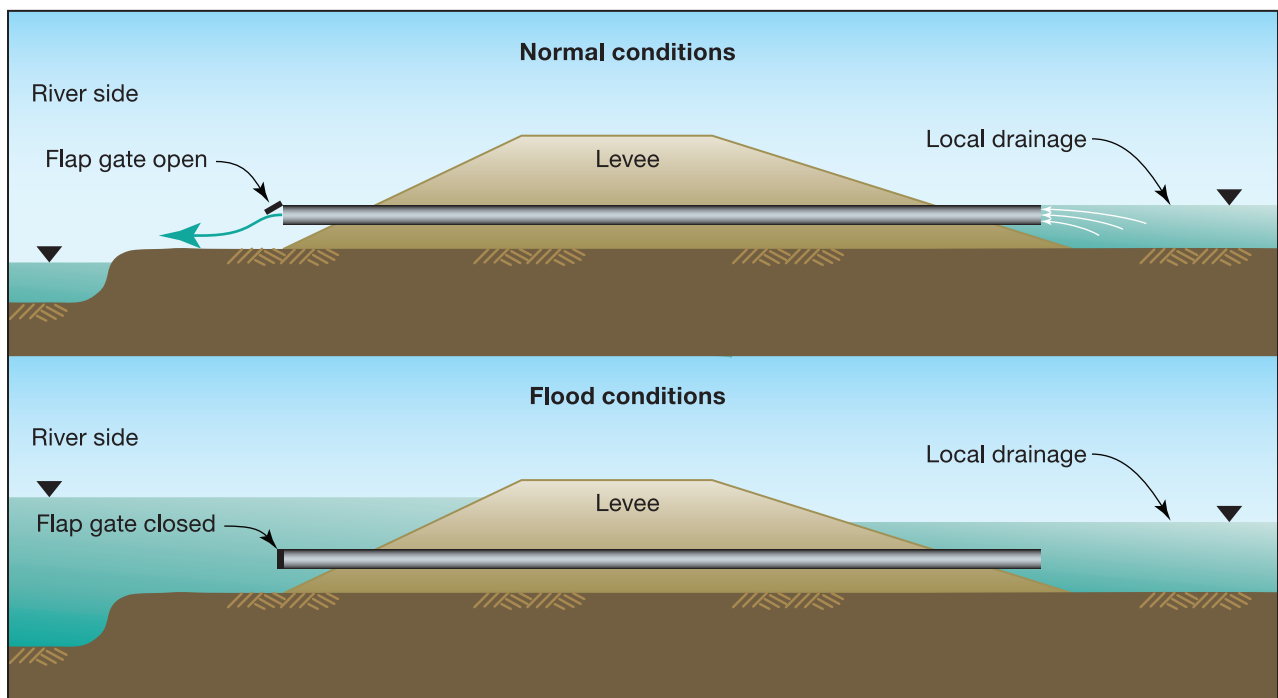
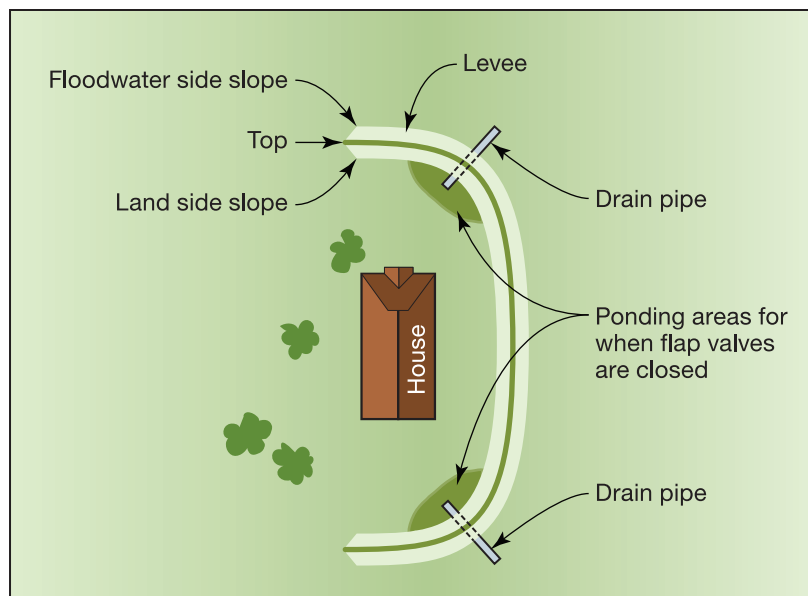

Figure 5F-30. Drain pipe extending through levee

To ensure that water from precipitation or seepage within a leveed area is removed during flooding, a sump pump should be installed in the lowest area encompassed by the levee. All interior drainage measures should lead to this pump, which will discharge the flow up and over the levee. The sump pump should have an independent power source so that it will remain in operation should there be an interruption of electrical power, a common event during a flood.

An alternative to the use of a sump pump (for minor storms), is the creation of an interior storage area that will detain all interior flow until the floodwaters can recede (see Figure 5F-31). Typically, the storage area is sized for the 2- or 10-year recurrence interval event.

Figure 5F-31.  
Interior storage area



### 5F.2.3.3 Levee Maintenance

Levee maintenance should include keeping the vegetation in good condition and preventing the intrusion of any large roots from trees or bushes or animal burrows, since they can create openings or weak paths in the levee through which surface water and seepage can follow, enlarging the openings and causing a piping failure. Planting of trees and bushes is not permitted on the levee.

Any levee design should include a good growth of sod on the top and slopes of the levee to protect against erosion by wind, water, and traffic, and to provide a pleasing appearance. Regular mowing, along with visual inspection several times a year, should identify critical maintenance issues.

### 5F.2.3.4 Levee Cost

The accuracy of a cost estimate is directly related to the level of detail in a quantity calculation. The following example provides a list of the common expenses associated with the construction of a residential levee. Unit costs vary with location and wholesale price index. To obtain the most accurate unit prices, the designer should consult construction cost publications or local contractors. The designer should also budget an additional 5 percent of the total construction capital outlay annually for maintenance of the levee. Refer to Figure 5F-32 for a Levee Cost Estimating Worksheet.

Levee Cost Estimating Worksheet				
Owner Name: _____		Prepared By: _____		
Address: _____		Date: _____		
Property Location: _____				
Item	Unit	Unit Cost 2009 Dollars	# Units Needed	Item Cost
Clearing and Grubbing	Acre	\$6,115		
Stripping Topsoil	Cubic Yards	\$0.70 to \$2.35		
Seeding	Thousand Square Feet	\$50 to \$67		
Sod	Thousand Square Feet	\$620 to \$960		
Haul Fill (1–5 miles round trip)	Cubic Yards	\$6.10 to \$14.75		
Haul Fill (5–15 miles round trip)	Cubic Yards	\$9.40 to \$28.25		
Import Fill	Cubic Yards	\$11.50 to \$16.25		
Compact Fill	Cubic Yards	\$1.00 to \$2.70		
Riprap/Stone Slope Protection	Cubic Yards	\$53		
Dig Inspection Trench: 2' x 4'	Linear Feet	\$5.70 to \$15.75		
Steel Drain Gate Valve	Each	\$825 to \$2,590		
Steel Drain Check Valve	Each	\$760 to \$1,615		
Sump and Sump Pump (with backup battery)	Each	\$1,140 to \$1,880		
Drain Tile (4"–6" diameter polyvinyl chloride)	Linear Feet	\$10.50 to \$12.75		
Drain Tile (8"–10" diameter polyvinyl chloride/ reinforced concrete pipe)	Linear Feet	\$13.50 to \$16.25		
Discharge Piping (1"–2" diameter polyvinyl chloride) for Sump Pump	Linear Feet	\$5.00 to \$6.10		
<b>Total Cost</b>				

Figure 5F-32. Levee Cost Estimating Worksheet

### 5F.2.4 Levee Construction

To prepare for the construction of a levee, all ground vegetation and topsoil should be removed over the full footprint of the levee. If sod and topsoil are present, they should be set aside and saved for surfacing the levee when it is finished.

#### 5F.2.4.1 Levee Soil Suitability

Most types of soils are suitable for constructing residential levees. The exceptions are very wet, fine-grained, or highly organic soils, defined as OL, MH, CH, and OH type soils by the NRCS. The best are those with a high clay content, which are highly impervious. Highly expansive clays should also be avoided because of potential cracking due to shrinkage.

#### 5F.2.4.2 Levee Compaction Requirements

As the levee is constructed, it should be built up in layers, or lifts, each of which must be individually compacted. Each lift should be no more than 6 inches deep before compaction (see Figure 5F-33). Compaction to at least 95 percent of standard laboratory density should be performed at or near optimum moisture content with pneumatic-tired rollers, sheepfoot rollers, or other acceptable powered compaction equipment. In some situations, certain types of farm equipment can affect the needed compaction.

Figure 5F-33.  
Compacted lifts

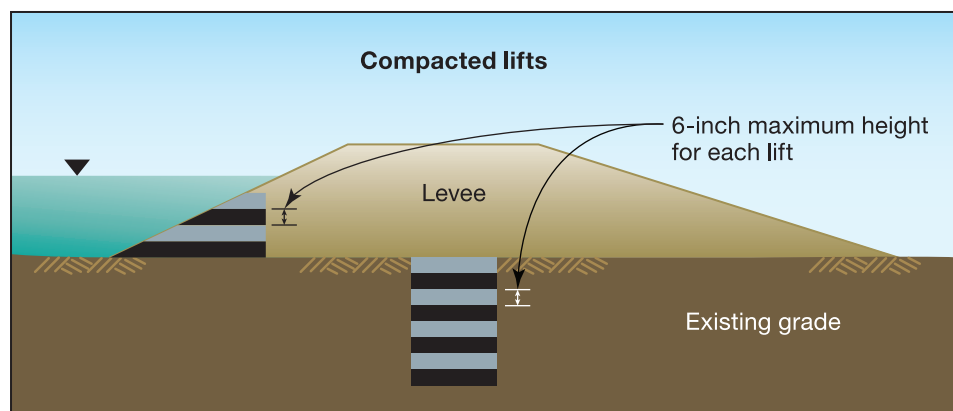

#### 5F.2.4.3 Levee Settlement Allowance

The levee should be constructed at least 5 percent higher than the height desired to allow for soil settlement.

#### 5F.2.4.4 Levee Borrow Area Restrictions

A principle concern for the construction of the levee is the availability of suitable fill for levee construction, but caution should also be taken as to the location of the fill borrow area.



#### WARNING

Settlement allowances vary by geographic region and geologic conditions. Therefore, a 5 percent allowance may not be applicable in all situations. Consult the State or local floodplain management officials for further information.

For the purpose of this manual, a general rule is to avoid utilizing a borrow area within 40 feet of the landward toe of the levee.

#### 5F.2.4.5 Access Across Levee

The complete encirclement of a structure with a levee can create access problems not only for the homeowner but also for emergency vehicles. If the levee is low enough, additional fill material can be added to provide a flat slope in one area for a vehicle access ramp running over the levee as shown in Figure 5F-34. Care should be taken to prohibit high volumes of traffic across the levee, which could result in the formation of ruts or the wearing away of the vegetative cover.

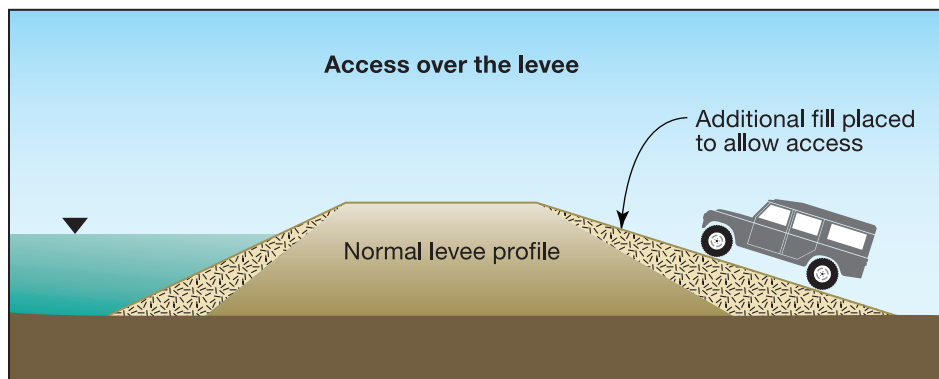

Figure 5F-34.  
Access over the levee

If it is necessary to have a gap in the levee, this can be closed during flooding through the use of a gate or closure structure. Additional details are provided in Chapter 5D. It should be noted that the use of a closure structure requires human intervention. If the structure in question is susceptible to flood hazards with little or no warning time, or if human intervention cannot be guaranteed, the use of a closure is not recommended.





# 5R Relocation

Relocation is the retrofitting measure that can offer the greatest security from future flooding (see Figure 5R-1). It involves moving an entire structure to another location, usually outside the floodplain. Selection of the new site is usually conducted by the homeowner, often in consultation with the designer to ensure that critical site selection factors such as floodplain location, accessibility, utility service, cost, and homeowner preference meet engineering and local regulatory concerns. Relocation as a retrofitting measure not only relieves anxiety about future flooding, but also offers the opportunity to reduce future flood insurance premiums.



Figure 5R-1.  
House relocation (photo  
courtesy of Wolfe House  
Movers)



The relocation process, as illustrated in Figure 5R-2, is fairly straightforward. There are, however, a number of design considerations to be addressed before embarking on this retrofitting measure. The nine steps involved with the relocation of a structure are discussed in more detail throughout this chapter.

Figure 5R-2.  
Relocation process



## 5R.1 Step 1: Select the House Moving Contractor

The selection of a moving contractor is one of the most important decisions a homeowner will make and may ultimately have the greatest impact on the success of the project. The designer can assist the homeowner in selecting an experienced home moving contractor. Some of the key elements of this selection (outlined in Figure 5R-3) include:

**Experience:** The homeowner and designer should visit recent projects the contractor has completed and talk to owners who recently went through the process to develop an opinion on the quality of work done.

**Financial Stability:** The homeowner/designer should determine whether and to what extent the contractor is licensed, insured, and bonded. A prudent homeowner will consider the potential risk of a failed project before enlisting the assistance of a contractor.

**Professionalism and Reputation:** The designer/homeowner may wish to check the contractor's reputation with the State licensing board, the local Better Business Bureau, local officials, and/or the International Association of Structural Movers (IASM). A critical question is whether or not the contractor is licensed to work in your area.

The designer/homeowner should also interview several contractors to determine:

- how well they may be able to work with this contractor;
- the extent of the contractor's knowledge; and
- what confidence may be had in the contractor's ability to complete the relocation project.

**Cost of Services:** While this should not be the sole determinant of contractor selection, cost of services is an important aspect of the relocation process. To ensure a comparison of similar levels of effort, the designer/homeowner should develop a detailed scope of services to be provided and have each contractor prepare a bid from the same scope of services. Remember, the most qualified contractor may not always have the highest cost and, conversely, the least qualified contractor may not have the lowest cost.



#### NOTE

The International Association of Structural Movers may be contacted at: P.O. Box 1213, Elbridge, NY 13060, (315) 689-9498, or <http://www.iasm.org> to obtain information on house relocation companies for a retrofitting project.

### Relocation Contractor Selection Checklist

#### 1. Experience of the Contractor:

- |  |           |          |
|--|-----------|----------|
| Recent, successful house re-elevation projects?                    | Yes _____ | No _____ |
| Satisfied clients providing good references?                       | Yes _____ | No _____ |
| Met time schedules?  | Yes _____ | No _____ |
| Cleaned up and restored old site?                                  | Yes _____ | No _____ |
| Quality product through your visual inspection of recent projects? | Yes _____ | No _____ |

#### 2. Financial Stability of Contractor:

- |           |           |          |               |
|-----------|-----------|----------|---------------|
| Bonded?   | Yes _____ | No _____ | Amounts _____ |
| Licensed? | Yes _____ | No _____ | Amounts _____ |
| Insured?  | Yes _____ | No _____ | Amounts _____ |

#### 3. Professionalism and Reputation of Contractor:

- State Licensing Agency: \_\_\_\_\_
- Better Business Bureau: \_\_\_\_\_
- Local Officials: \_\_\_\_\_
- International Association of Structural Movers: \_\_\_\_\_
- Results of the Interview: \_\_\_\_\_

#### 4. Cost of Services: \_\_\_\_\_

#### 5. Summary of References: \_\_\_\_\_

Figure 5R-3. Relocation contractor selection checklist

## 5R.2 Step 2: Analyze the Existing Site and Structure

The designer should help the homeowner to ensure that the contractor conducts an analysis of the existing site and structure to determine the critical criteria for the relocation of the structure. These criteria will include:

- Is there sufficient space around the structure for the installation of lifting beams and truck wheels?
- Can the structure be lifted as one piece or must it be separated into sections?
- Depending on the final assessment of the structure's conditions, how much bracing will be required to successfully move this structure?
- Will this structure survive the lift and a move of the distance proposed by the homeowner?
- Which utilities must be disconnected and where?
- What local regulations govern demolition of the remaining portions of the structure (foundation and paved areas) and to what standard must the site be restored?



### WARNING

Usually the analysis of the existing site and structure is conducted by the moving contractor and not by the homeowner's designer. However, it is important that the designer/homeowner coordinate and communicate with the contractor regarding the issues related to the analysis of the existing site and structure for relocation.

The contractor usually has experience in analyzing the existing structure to determine:

- the size and placement of lifting beams, jacks, and lateral or cross beams; and
- whether the structure should be elevated and moved in one piece or elevated and moved several pieces.

The final decision on these items may not be made until an evaluation of the moving route is conducted, as the moving route can present other factors the contractor must consider (see Step 5).

**Lifting Beam Placement:** Each of the following factors affecting the placement of lifting beams must be considered during the elevation and relocation process:

- size and shape of the house;
- existing framing and parameters;
- deflection limitations; and
- distribution of the house's weight.



### WARNING

If the selected contractor is not familiar with factors regarding lifting beam placement, the homeowner and designer might reconsider their contractor selection.

The major consideration for the placement of lifting beams is to limit cracking due to excessive deflections during preparation, moving, and settling in place. The lifting beams, in tandem with cross or lateral beams, must sufficiently support the structure. When the house is removed from the foundation, the lifting and lateral beams should provide as stable a support as the original foundation.

Deflection of any portion of the structure is normally a result of the manner in which the weight of the house is distributed, the location of the jacks under the lifting beams, and the rigidity of the lifting beam. Proper placement of lifting beams, jacks, and lateral beams will protect against cracking of both the interior and exterior finishes, as well as ensure the integrity of the entire house.

A second consideration concerning the installation of lifting beams is to ensure that they are located so that the house can be attached to truck wheel sets forming a trailer.

The route to be taken during the relocation of the house dictates the physical size and weight limitations of the structure, due to the horizontal and vertical clearances from obstructions. The house may have to be cut into sections which are moved separately to negotiate the available route. Lifting beams, therefore, would have to be placed for each section to be moved. The entire elevation framing must also be rigid enough to take the forces associated with physical movement of the house.

Heavier construction materials on certain portions of the house, such as brick veneer, chimneys, and fireplaces, causes additional deflection and warrants special attention when determining the lifting beam system. Even with minimal deflection, brick construction is subject to cracking. Therefore, extra precautions, in the form of additional beam support or removal of the brick for possible later replacement, will be needed.

The size and shape of the house also affects the placement and number of lifting beams. A simple rectangular floor plan allows for the easiest and most straightforward type of elevation project. Generally, placement of the longitudinal lifting beams, with lateral beams located as required, is the system utilized for the elevation process. Larger or more complex shapes, such as L-shaped or multi-level houses, necessitate additional lifting beams and jacks to provide a stable lifting support system. Every consideration of the load based upon the size and shape of the house should be incorporated into the design and layout of the lifting beam system.

### 5R.3 Step 3: Select, Analyze, and Design the New Site

The selection of a new site for a relocated house will require the examination of potential sites with regard to:

- floodplain location;
- utility extension feasibility;
- accessibility; and
- permitting feasibility.

The process is similar to selecting a lot upon which to design and build a new house. Local building codes and approval processes must be followed. In some instances, the homeowner may be required to upgrade existing mechanical, electrical, and plumbing systems to meet current code requirements.

**Site Access:** An important consideration in the selection of a new site is the accessibility of the site for both the house movers and the new site construction crews. Severe site access constraints can increase the cost of the retrofit measures. Constraints can also require cleaning and grading activities, which may diminish the site characteristics initially desired by the homeowner.



#### NOTE

Information on site design standards may be obtained from the local building official, or, if there is none, from the HUD's publication ACCN-6212, Proposed Model Land Development Standards and Accompanying State Enabling Legislation (HUD,1993)..

**Permits:** The designer/homeowner should make certain that, when the house is moved to the new lot, it will conform to all the zoning and construction standards in effect at the time of relocation. The designer should contact the local regulatory officials to determine the design standards and submission process requirements that govern development of a new site. All permits required for construction at the new site and for transporting the house to the new site should be obtained prior to initiating the relocation process.

## 5R.4 Step 4: Prepare the Existing Site

Initial preparation of the site includes clearing all vegetation from the area in and around the footprint of the house (see Figure 5R-4). This is done to clear a path beneath the house to allow the insertion of beams for lifting supports. These pathways should be deep enough to allow for the movement of both people and machinery.

Figure 5R-4.  
Clearing pathways  
beneath the structure for  
lifting supports (photo  
courtesy of Wolfe House  
Movers)



## 5R.5 Step 5: Analyze and Prepare the Moving Route

Once the relocation site has been selected, a route for transport must be analyzed and selected. This route should be carefully chosen and planned well in advance of the design of the new site or the undertaking of any relocation process activities at the existing site.

**Identify Route Hazards:** Make certain that the house, as it will be moved, will be able to navigate the following:

- narrow passages, such as road cuts and widths;
- bridge weight limits and widths;

- utility conflicts, such as light poles, and electric and telephone lines;
- fire hydrants;
- road signs;
- steep grades;
- traffic signals; and
- tight turns around buildings, bridges, and overpasses.

**WARNING**

Timing may be critical in areas that have heavy traffic during morning and evening rush hours. Houses are often relocated during the late evening and early morning hours.

Care should be taken to ensure that the structure will clear all overhead utility lines. Many of these can be lifted during the move, but utility companies sometimes require the presence of their employees and will charge for this service. In some instances, an overland (non-road) route may be the best alternative.

**Obtain Approvals:** It may be necessary to obtain moving permits, not only for the area from which the structure is being moved, but also in jurisdictions through which the structure is passing. Approvals for transport in a public right-of-way may be required from local governments, highway departments, and utility companies. Often approvals may be necessary from private landowners whose properties are either crossed or affected by the move.

The time required to obtain approvals and the complexity of information some parties may require in order to provide approvals may vary widely. The designer/contractor and homeowner should investigate this approval process early in the relocation effort to minimize potential delays due to obtaining permits.

**Coordinate Route Preparation:** The moving contractor should be responsible for the necessary coordination made along the moving route. This includes:

- the raising or relocation of utilities by utility companies;
- any road/highway modifications, such as traffic lights, signage, temporary bridges, etc.; and
- clearing/grubbing of overland areas, where necessary.

The moving contractor should also be responsible for making sure that these facilities are returned to their normal operating condition as soon as the move is completed.

## 5R.6 Step 6: Prepare the Structure

The steps involved in preparing a structure to be moved are described below.

**Disconnect Utilities:** The first step in preparing the structure is to disconnect all the utilities connected to the structure. Specific requirements governing the capping, abandoning, and/or removal of specific utilities should be available from the local utility companies and/or the local regulatory officials.

**Cut Holes in Foundation Wall for Beams:** From beneath the structure, the pathways for lifting beams are cut into the existing foundation (see Figure 5R-5).



Figure 5R-5.  
Pathways for lifting  
beams (photo courtesy of  
Wolfe House Movers)



**Install Beams:** Lifting and lateral beams are placed beneath the structure at all critical lift points and support cribbing is added as the structure is separated from its old foundation (see Figure 5R-6).

Figure 5R-6.  
Beams supported by  
cribbing are placed at  
critical lift points (photo  
courtesy of Wolfe House  
Movers)





**Install Jacks:** Jacks are used to lift the structure from its foundation (see Figure 5R-7). Various types of jacking systems may be employed as long as gradual and uniform lifting pressures are utilized to lift the structure.



Figure 5R-7.  
Hydraulic jacks installed  
to lift structure from  
foundation (photo  
courtesy of Wolfe House  
Movers)

**Install Bracing as Required:** Bracing may need to be installed to maintain the integrity of the structure.

**Separate Structure from Foundation:** The structure now stands free from its former foundation (see Figure 5R-8).



Figure 5R-8.  
Structure is separated  
from its foundation  
(photo courtesy of Wolfe  
House Movers)

## 5R.7 Step 7: Prepare the New Site

The new site is prepared for the arrival of the structure.

**Design Foundation:** The steps needed to design the new foundation have been defined in Chapter 5E.

**Design Utilities:** Utilities must be available to be brought directly to the structure at the new site. Construction should be accomplished in accordance with the approved set of design documents prepared for the new site and any building permit conditions specified by local officials (as explained in Step 3).

**Excavation and Preparation of New Foundation:** At the new site, excavation and preparation of the foundation are underway (see Figure 5R-9).

**Construction of Support Cribbing:** Support cribbing is put in place to allow the structure to be jacked up and the truck wheel sets are removed. With support cribbing in place, materials for completion of the foundation are readied.

**Construction of Foundation Walls:** The foundation wall construction begins (see Figure 5R-10).

Figure 5R-9.  
Foundation preparation at  
new site (photo courtesy  
of Wolfe House Movers)







Figure 5R-10.  
New foundation wall  
construction begins  
(photo courtesy of Wolfe  
House Movers)

## 5R.8 Step 8: Move the Structure

Once the structure has been raised, it is transported to the new site. This process is outlined below.

**Excavate/Grade Temporary Roadway:** Excavation and grading of a temporary roadway is done at one end of the structure. The truck wheels, which will form the trailer that will be used to move the house, are brought to the site and placed beneath the lifting and lateral beams (see Figure 5R-11).



Figure 5R-11.  
Trailer wheel sets are  
placed beneath the lifting  
beams (photo courtesy of  
Wolfe House Movers)

**Attach Structure to Trailer:** The house is attached to the truck wheels and then attached to the tractor/bulldozer in preparation for the moving of the structure from its original site (see Figure 5R-12). The tractor/bulldozer is used to pull the house to street level, while workers continually block the wheels to prevent sudden movement. At street level, the house is stabilized and a truck is connected to the trailer for the journey to the new site.

**Transport Structure to New Site:** With connections to the truck completed, the actual transport of the structure to the new site begins.

**Lower Structure onto Foundation:** Once the desired height of the new wall is reached, the house is lowered onto its new foundation, cribbing is removed, and foundation walls are completed (see Figure 5R-13).

Figure 5R-12.  
Trailer is used to pull the house to the street (photo courtesy of Wolfe House Movers)



Figure 5R-13.  
House is lowered and connected to the foundation after foundation walls are completed (photo courtesy of Wolfe House Movers)



**Landscaping:** Finishing touches, like preparing the foundation for backfilling and landscaping, are done to blend in the house with its new environment.

## 5R.9 Step 9: Restore the Old Site

Once the structure is removed from the site, certain steps need to be taken to stabilize the site in accordance with local regulations. Many homeowners have sold or deeded these abandoned properties to local municipalities for the development of parkland and/or open space. In any case, permits for the demolition of the old site, remaining foundation, and remaining utility systems, as well as grading and site vegetative stabilization are normally required.

**Demolish and Remove Foundation and Pavement:** The old basement may have to be backfilled to eliminate any potential hazards. Check local regulations to see if old foundation and utility connections have to be removed.

**Disconnect and Remove All Utilities:** Following up on the disconnection and capping of utility services previously discussed in Step 6, the homeowner may be required to remove all existing utility systems from the site. Septic tanks and oil/gas storage tanks on site may be governed by specific environmental guidelines, which must be followed to ensure that leakage to groundwater sources does not occur. Depending upon the age and condition of the tanks, the homeowner may be required to drain and remove these tanks, or drain and stabilize the underground tanks against flotation.

The homeowner may also be required to test the soil around an underground tank to determine if leakage has occurred. If leakage is confirmed, the homeowner is usually responsible for cleaning the contaminated soils. When facing this situation, the homeowner should contact a qualified geotechnical or environmental engineer. Specific requirements governing the capping, abandoning, and/or removal of specific utilities should be determined from the local utility companies and/or the local regulatory officials.



### NOTE

Material from drained septic, oil, and gas storage tanks must be disposed of in a safe and legal manner.

**Grading and Site Stabilization:** The old site may have to be regraded after all the excavation and movement by the heavy equipment. The lot will need to be stabilized with vegetation as appropriate to its intended future use.







# 5W Wet Floodproofing

Wet floodproofing can be defined as permanent or contingent measures applied to a structure and/or its contents that prevent or provide resistance to damage from flooding by allowing floodwater to enter the structure. The basic characteristic that distinguishes wet floodproofing from dry floodproofing is that it allows internal flooding of a structure as opposed to providing essentially watertight protection.



## NOTE

Wet floodproofing is appropriate for basements, garages, and enclosed areas below the flood protection level.

Flooding of a structure's interior is intended to counteract hydrostatic pressure on the walls, floors, and supports of the structure by equalizing interior and exterior water levels during a flood. Inundation also reduces the danger of buoyancy from hydrostatic uplift forces. Such measures may require alteration of a structure's design and construction, use of flood-resistant materials, adjustment of building operations and maintenance procedures, relocation and modification of equipment and contents, and emergency preparedness for actions that require human intervention. This chapter examines:

- protection of the structure;
- design of openings for intentional flooding of enclosed areas below the DFE;
- use of flood-resistant materials;
- adjustment of building operations and maintenance procedures;
- the need for emergency preparedness for actions that require human intervention; and
- design of protection for the structure and its contents, including utility systems and appliances.



**WARNING**

The NFIP allows wet floodproofing only in limited situations. The most common application is with pre-FIRM structures not subject to substantial damage and/or substantial improvement criteria. Structures in the pre-FIRM category can utilize any retrofitting method. However, for new structures or those that have been substantially damaged or are being substantially improved, application of wet floodproofing techniques is limited to the following situations:

Enclosed areas below the BFE that are used solely for building access, parking, or limited storage. These areas must be designed to allow for the automatic entry and exit of floodwater through the use of openings, and be constructed of flood-resistant materials.

Attached garages. A garage attached to a residential structure, constructed with the garage floor slab below the BFE, must be designed to allow for the automatic entry and exit of floodwater. Openings are required in the exterior walls of the garage or in the garage doors. In addition, the areas below the BFE must be constructed with flood-resistant materials.

FEMA has advised communities that variances to allow wet floodproofing may be issued for certain categories of structures. Refer to FEMA's NFIP Technical Bulletin 7-93, Wet Floodproofing Requirements for Structures Located in Special Flood Hazard Areas in Accordance with the National Flood Insurance Program (FEMA, 1993b).

## 5W.1 Protection of the Structure

As with dry floodproofing techniques, developing a wet floodproofing strategy requires site-specific evaluations that may necessitate the services of a design professional. The potential for failure of various structural components (foundations, cavity walls, and solid walls) subjected to inundation is a major cause of structural damage. Some of the reasons a house would need to be wet floodproofed include the following:

- it is a pre-FIRM house located in an area below the BFE;
- it is an historic structure and elevating it is not an option;
- it has an attached garage;
- it is located in an area above the BFE where there is significant flooding potential; or
- it has accessory structures (e.g., detached garage or storage shed).

The following is an explanation of various building systems that can be wet floodproofed. Each section explains the typical building materials used to construct them and cautions the user about various methods.

In some locations, the use of ASCE 24 may be required by the building codes. This standard includes minimum requirements for wet floodproofing (Section 6.3), specifically the limitations of use for the space

**NOTE**

FEMA strongly encourages that flood retrofits provide protection to the DFE (or BFE plus 1 foot, whichever is higher). However, in some situations a lower flood-protection level may be appropriate. Homeowners and design professionals should meet with a local building official to discuss the selected retrofit measure and the elevation to which it will protect the home. The text and examples in this manual assume flood protection measures will be implemented to the DFE.

and design load minimums; it also presents requirements for the utilities located below the minimum elevation requirements. Other sections of the standard discuss flood-resistant materials (Section 5.0) and minimum design elevations below which more stringent design requirements are required (Table 6-1 of ASCE 24).

While wet floodproofing offers an improved level of protection for a structure, extended floodwater inundation of areas subject to flooding could still cause damage to the materials. Additionally the areas above the wet floodproofing are still at risk of damage. This damage could result from higher than expected floodwater, contamination, or toxic materials in close proximity to the house, or growth of mold from extended inundation or higher than normal levels of humidity. There is remaining risk for the areas either wet floodproofed or above the wet floodproofing. This risk is referred to as the residual risk for the structure. While this remaining or residual risk can be financially minimized with the purchase of flood insurance, a homeowner living in a flood-prone area should be aware that some level of risk cannot be eliminated by either physical risk reduction measures like floodproofing or financial risk reduction measures like insurance. The extent of their selected level of protection should be consonant with their ability to absorb the implications of the residual risk. Many design guidance documents and design standards such as ASCE 24 incorporate freeboard, or additional elevation above the BFE, to serve as a risk reduction tool. However, the designer and homeowner should be aware that in some instances floodwater can exceed even freeboard elevations and determine methods of addressing this inherent residual risk.

### 5W.1.1 Foundations

The ability of floodwater to adversely affect the integrity of structure foundations by eroding supporting soil, scouring foundation material, and undermining footings necessitates careful examination of foundation designs and actual construction. Footings should be located deep enough below grade so that flood-related erosion does not reach the top of the footing. In addition, it is vital that the structure be adequately anchored to the foundation. A continuous load path is necessary due to uplift forces during a flood event, which are often great enough to separate an improperly anchored structure from its foundation should floodwater reach such a height. Foundation walls must be checked for lateral support to verify that any lateral forces imposed by floodwater can be resisted. Areas where cripple walls are used should be checked to verify that they are properly braced.

### 5W.1.2 Cavity Walls

Wet floodproofing equalizes hydrostatic pressure throughout the structure by allowing floodwater to enter the structure and equalize internal and external hydrostatic pressure. Thus, any attempt to seal internal air spaces within the wall system is not only technically difficult, but is also contrary to the wet floodproofing approach. Provisions must be made for the cavity space to fill with water and drain at a rate approximately equal to the floodwater rate of rise and fall. Insulation within cavity walls subject to inundation should also be a type that is not subject to damage from floodwater. The design of foundation openings to equalize hydrostatic pressure is covered in Section 5E.1.2.1. Following a flooding event, it may be necessary to remove one side of a cavity wall to allow the interior to properly dry. It is also necessary to verify that drainage or weep holes remain clear of debris. Although not always an indicator of water trapped within a cavity wall system, the presence of efflorescence (white staining) on a wall system may indicate that the wall may not be properly draining and that the cavity does not have sufficient drainage holes. This type of staining may be present in cavity walls and solid walls and indicate the significant transfer of moisture.

### 5W.1.3 Solid Walls

Solid walls are designed without internal spaces that could retain floodwater. Because these walls can be somewhat porous, they can absorb moisture and, to a limited degree, associated contaminants. Such intrusion could cause internal damage, especially in a cold (freeze-thaw) climate. Therefore, where solid walls are constructed of porous material, the retrofitting measures should include both exterior and interior protective cladding to guard against absorption. Some liquid products may be applied to each face of porous wall systems. It is possible for voids or cavities within solid wall systems to be open and not grouted and, therefore, retain additional moisture. These are difficult to grout as a retrofit, but it may be necessary to allow them to drain following a major flooding event.



#### CROSS REFERENCE

Detailed guidance is provided in FEMA's NFIP Technical Bulletin 2-08, *Flood-Resistant Materials Requirements for Buildings Located in Special Flood Hazard Areas in Accordance with the National Flood Insurance Program* (FEMA, 2008a).



#### CROSS REFERENCE

Additional information on these elements can be obtained from FEMA's NFIP Technical Bulletin 7-93, *Wet Floodproofing Requirements for Structures Located in Special Flood Hazard Areas in Accordance with the National Flood Insurance Program* (FEMA, 1993b).

## 5W.2 Use of Flood-Resistant Materials

In accordance with the NFIP, all materials exposed to floodwater must be durable, resistant to flood forces, and retardant to deterioration caused by repeated exposure to floodwater. Interior building elements such as wall finishes, floors, ceilings, roofs, and building envelope openings can also suffer considerable damage from inundation by floodwater, which can lead to failure or an unclean situation. The exterior cladding of a structure subject to flooding should be nonporous, resistant to chemical corrosion or debris deposits, and conducive to easy cleaning. Interior cladding should be easy to clean and not susceptible to damage from inundation. Likewise, floors, ceilings, roofs, fasteners, gaskets, connectors, and building envelope openings should be constructed of flood-resistant materials to minimize damage during and after floodwater inundation.

Generally, these performance requirements indicate that masonry construction is the most suited to wet floodproofing in terms of damage resistance. In some cases, wood or steel structures may be candidates, provided that the wood is pressure treated or naturally decay-resistant and steel is galvanized or protected with rust-retardant paint. A detailed list of appropriate materials can be found in NFIP Technical Bulletin 2-08, *Flood-Resistant Materials Requirements for Buildings Located in Special Flood Hazard Areas in Accordance with the National Flood Insurance Program*. Table 2 of Technical Bulletin 2-08 can be used as a guide for selecting structural (framing and some sheathing) and nonstructural (coverings,



#### WARNING

The use of wall coverings in flood-prone areas needs to be carefully researched. Standard gypsum board is not considered a flood resistant material. Water-resistant gypsum board, commonly referred to as "greenboard," is intended for areas where water may be splashed such as around bathroom sinks; however, it is not considered to be a flood-damage-resistant material. Only products such as cement board or proprietary products designed for submersion in water should be considered for use in areas subject to floodwater.

finishes, insulation, cabinets, doors, partitions, and windows) building components for use below the BFE. Some combinations of acceptable materials may result in unacceptable conditions; always refer to the manufacturer's specifications for more information. In addition to the material selection, Technical Bulletin 2-08 also explains the criteria for selecting connectors and fasteners for below the BFE. It should be noted, however, that the locally enforced building code may include more strict provisions than those stated in Technical Bulletin 2-08.

## 5W.3 Building Operations and Maintenance Procedures and Emergency Preparedness Plans

The operational procedure aspect of applying floodproofing techniques involves both the structure's functional requirements for daily use and the allocation of space with consideration of each function's potential for flood damage. Daily operations and space use can be organized and modified to minimize damage caused by floodwater.

### 5W.3.1 Flood Warning System

Because wet floodproofing will, in most cases, require some human intervention when a flood is imminent, it is extremely important that there be adequate time to execute such actions. This may be as simple as monitoring local weather reports, the NWS alarm system, or a local flood warning system.

### 5W.3.2 Inspection and Maintenance Plan

Every wet floodproofing design requires some degree of periodic inspection and maintenance to ensure that all components will properly operate under flood conditions. Components of the system, including valves and opening covers, should be inspected and operated at least annually.

It is advisable to consider adding more flood openings to ensure they are easily opened and will allow floodwater to enter the building as planned.

Homeowners and designers should consider developing a plan for elevating belongings in storage areas prior to the arrival of floodwater because, over time, contents may increase in this area and it may be difficult to quickly move tightly packed contents.

Some owners have used a line or marking on the wall to illustrate BFEs or historic floods as a reference/reminder of how high off the ground contents that would be damaged by floodwater should be stored.



#### NOTE

Utility systems include heating and air conditioning systems, appliances, electrical/plumbing systems, and water service/sewer facilities.

### 5W.3.3 Emergency Operations Plan

This type of plan is essential when wet floodproofing requires human intervention, such as adjustments to or relocation of contents and utilities. A list of specific actions and the location of necessary materials to perform these actions should be developed.



### 5W.3.4 Protection of Utility Systems

The purpose of the retrofitting methods in this section is to prevent damage to building contents and equipment caused by contact with floodwater by isolating these components from floodwater. Isolation of these components can take the form of relocation, elevation, or protection in place (see Figure 5W-1).

**Figure 5W-1.**  
Elevated air conditioning  
compressor



Local codes may require the use of ASCE 24, which covers utilities in Section 7.0. The standard provides guidance on electrical; plumbing; sanitary sewer; mechanical; heating, ventilation, and air conditioning (HVAC) systems; and elevators. Depending on the building classification, Table 7.1 of ASCE-24 states minimum elevation requirements for utility and attendant equipment protection. Utilities and attendant equipment below this elevation will require increased loading and design requirements. Some of these requirements state minimum loading requirements, while others state use requirements during and immediately after a design flood event. Although utilities and attendant equipment may be located above the minimum requirements, these requirements also cover wires, pipes, lines, etc., that are located below the minimum elevation.

## 5W.4 Elevation

The most effective method of protection for equipment and contents is to elevate and/or relocate (permanently or temporarily) threatened items out of harm's way. The interior of the structure must be organized in a way that ensures easy access, facilitates relocation, and meets current building code requirements.

Both inside and outside of the flood-prone structure, elevation of key components may be achieved through the use of existing or specially constructed platforms or pedestals. Contingent elevation can be accomplished by the use of hoists or an overhead suspension system. Relocated utilities placed on pedestals are subject to wind and earthquake damage and must be secured to resist wind and seismic forces.

Conversion from a conventional water heater to a tankless water heater is another mitigation opportunity. Although there are conflicting reports on the expected savings to be gained by the conversion, the conversion allows the unit to be moved well above the BFE in many instances. Electrically heated units may have the option of being located inside the house, but liquid propane or natural gas units should be well ventilated and located on the exterior of the house or in a garage or other area. In some instances, energy tax credits may be available to assist in offsetting the higher purchase cost. Either type of unit should always be installed by a licensed plumbing or heating/air contractor.



### CROSS REFERENCE

Refer to FEMA 348, *Protecting Building Utilities from Flood Damage: Principles and Practices for the Design and Construction of Flood Resistant Building Utility Systems* (FEMA, 1999a) for details on the protection of utility systems.

## 5W.5 In-Place Protection

Some types of utilities can be protected in place through a variety of options, such as:

- anchors and tie-downs to prevent flotation;
- low barriers or shields; and
- protective coatings.

The use of flood enclosures to protect utilities (see Figure 5W-2) should be considered an option of last resort and should not be considered a best practice. Floodwater exceeding the predicted height or failure of low barriers or shields can result in loss of the entire unit. This alternative should only be considered if there is no possible way to relocate the unit. Utility systems as used here are mechanical, electrical, and plumbing systems, including water, sewer, electricity, telephone, CATV, natural gas, etc. The recommendations presented in this section are intended for use individually or in common to mitigate the potential for flood-related damage.



### WARNING

Regardless of the method of protection, any adjustments or modifications to retrofit building utility systems should be completed in accordance with local building code requirements.



### NOTE

Basic process for protection of utility systems:

- Field Investigation
- Design
- Construction

**Figure 5W-2.**  
**Flood enclosure protects**  
**basement utilities from**  
**shallow flooding**  
 SOURCE: FEMA 348, 1999A

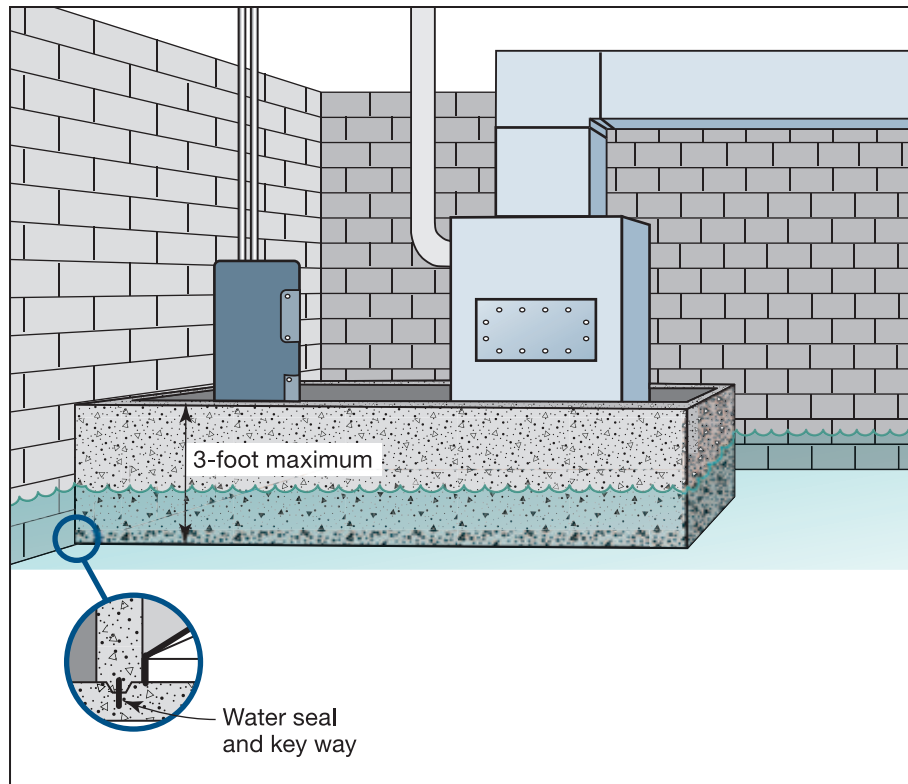

Developing in-place protection should incorporate design elements into the solution. Walls should be designed with some factor of safety above the floodwater elevation. The wall should be designed to the DFE to incorporate a factor of safety into the protection. The protection measure should be able to resist the hydrostatic loads for the full height of the wall system. Maintenance access to the utility should be carefully considered. It is important to create a passive protection system. Under normal use, the utility should be protected from floodwater and accessible only during times of maintenance. This measure will ensure that the homeowner is not at risk when floodwater rises. Penetrations through the in-place protection should also be sealed to prevent the intrusion of floodwater. Finally the design should consider offset distances from the equipment. Utility systems requiring air flow or air circulation of safety or proper operation should not be enclosed by walls so tightly that it causes improper operation of the unit or causes a safety issue to develop.

## 5W.6 Field Investigation

Detailed information must be obtained about the existing structure to make decisions and calculations concerning the feasibility of using wet floodproofing. Use Figures 5-2 and 5-3 as a guide to record information.

Once this data is collected, the designer should answer the questions contained in Figure 5W-3, to confirm the measure(s) selected and develop a preliminary concept for the installation of wet floodproofing measures.

Once a conceptual approach toward wet floodproofing has been developed, the designer should discuss the following items with the homeowner:

- previous flood history, flood depths, and equipment/systems impacted by the floods;



- plan of action as to what equipment can be relocated and what equipment will have to remain below the DFE;
- length of power outages, water shut-off, or fuel shut-off for work to be completed;
- specific scope of items to be designed; and
- any unsafe practices or code violations or exceptions to current codes.

Flood-Resistant Retrofitting Field Investigation Worksheet	
Owner Name: _____	Prepared By: _____
Address: _____	Date: _____
Property Location: _____	
<b>Design Flood Elevation (DFE)</b> _____	
<b>HVAC System</b>	
Can equipment feasibly be relocated:	
<ul style="list-style-type: none"> <li>• To a pedestal or balcony above the DFE? ___ Yes ___ No</li> <li>• To a higher level on the same floor level? ___ Yes ___ No</li> <li>• To the next floor level? ___ Yes ___ No</li> <li>• Is space available for the equipment in the alternate location? ___ Yes ___ No</li> <li>• Can existing spaces be modified to accept equipment? ___ Yes ___ No</li> <li>• Is additional space needed? ___ Yes ___ No</li> <li>• Do local codes restrict such relocations? ___ Yes ___ No</li> <li>• Can all equipment be protected in-place? ___ Yes ___ No</li> <li>• Is it feasible to install a curb or "pony" wall around equipment to act as a barrier? ___ Yes ___ No</li> <li>• Is it feasible to construct a waterproof vault around equipment below the DFE? ___ Yes ___ No</li> <li>• Can reasonably sized sump pumps keep water away from the equipment? ___ Yes ___ No</li> </ul>	
<b>Fuel System</b>	
Can equipment feasibly be relocated:	
<ul style="list-style-type: none"> <li>• To a pedestal or balcony above the DFE? ___ Yes ___ No</li> <li>• To a higher level on the same floor level? ___ Yes ___ No</li> <li>• To the next floor level? ___ Yes ___ No</li> <li>• Is space available for the equipment in the alternate location? ___ Yes ___ No</li> <li>• Can existing spaces be modified to accept equipment? ___ Yes ___ No</li> <li>• Is additional space needed? ___ Yes ___ No</li> <li>• Do local codes restrict such relocations? ___ Yes ___ No</li> <li>• Can all equipment be protected in-place? ___ Yes ___ No</li> <li>• Is the tank properly protected against horizontal and vertical forces from velocity flow and buoyancy? ___ Yes ___ No</li> <li>• Is it feasible to install a curb or "pony" wall around equipment to act as a barrier? ___ Yes ___ No</li> <li>• Can reasonably sized sump pumps keep water away from the equipment? ___ Yes ___ No</li> <li>• Is the meter properly protected against velocity and impact forces? ___ Yes ___ No</li> <li>• Do local code officials and the gas company allow the meter to be relocated to a higher location? ___ Yes ___ No</li> </ul>	

Figure 5W-3. Flood-Resistant Retrofitting Field Investigation Worksheet

**Electrical System**

- Is it feasible to relocate the meter base and service lateral above the DFE? \_\_\_ Yes \_\_\_ No
- Is it feasible to relocate the main panel and branch circuits above the DFE? \_\_\_ Yes \_\_\_ No
- Is it feasible to relocate appliances, receptacles, and circuits above the DFE? \_\_\_ Yes \_\_\_ No
- Is it feasible to relocate light switches and receptacles above the DFE? \_\_\_ Yes \_\_\_ No
- Can ground fault interrupter protection be added to circuits below the DFE? \_\_\_ Yes \_\_\_ No
- Can service lateral outside penetrations be sealed to prevent water entrance? \_\_\_ Yes \_\_\_ No
- Can cables and/or conduit be mechanically fastened to prevent damage during flooding? \_\_\_ Yes \_\_\_ No
- Can splices and connections be made water-resistant or relocated above the DFE? \_\_\_ Yes \_\_\_ No
- Do local code officials and electric companies allow the elevation of the meter? \_\_\_ Yes \_\_\_ No

**Sewage Management System**

- Can the on-site system be protected in-place? \_\_\_ Yes \_\_\_ No
- Is it feasible to anchor the tank? \_\_\_ Yes \_\_\_ No
- Can the distribution box and leech field be protected from scour and impact forces? \_\_\_ Yes \_\_\_ No
- Can the supply lines be properly protected from scour and impact forces? \_\_\_ Yes \_\_\_ No
- Can backflow prevention valves be used to minimize flow of sewage into the building? \_\_\_ Yes \_\_\_ No
- Can equipment feasibly be relocated? \_\_\_ Yes \_\_\_ No
- Can the system be moved to a higher elevation on the property? \_\_\_ Yes \_\_\_ No
- Can the tank be relocated to a higher elevation or indoors? \_\_\_ Yes \_\_\_ No
- Can the drains and toilets be relocated above the DFE? \_\_\_ Yes \_\_\_ No
- Is space available for the equipment in the alternate location? \_\_\_ Yes \_\_\_ No
- Can existing spaces be modified to accept equipment? \_\_\_ Yes \_\_\_ No
- Is additional space needed? \_\_\_ Yes \_\_\_ No
- Do local codes restrict such relocations? \_\_\_ Yes \_\_\_ No

**Potable Water System**

- Can the equipment feasibly be relocated? \_\_\_ Yes \_\_\_ No
- Can the well be moved to a higher elevation on the property? \_\_\_ Yes \_\_\_ No
- Can the electric controls for the well be protected from inundation? \_\_\_ Yes \_\_\_ No
- Can the tank be relocated to a higher elevation or indoors? \_\_\_ Yes \_\_\_ No
- Can the taps be relocated above the DFE? \_\_\_ Yes \_\_\_ No
- Is space available for the equipment in the alternate location? \_\_\_ Yes \_\_\_ No
- Can existing spaces be modified to accept equipment? \_\_\_ Yes \_\_\_ No
- Is additional space needed? \_\_\_ Yes \_\_\_ No
- Do local codes restrict such relocations? \_\_\_ Yes \_\_\_ No
- Can the well be protected in-place? \_\_\_ Yes \_\_\_ No
- Is it feasible to install a curb or “pony” wall around equipment to act as a barrier? \_\_\_ Yes \_\_\_ No
- Is it feasible to construct a waterproof vault around equipment below the DFE? \_\_\_ Yes \_\_\_ No
- Can the wellhead and tank be protected from scour and impact forces? \_\_\_ Yes \_\_\_ No
- Can the supply lines be properly protected from scour and impact forces? \_\_\_ Yes \_\_\_ No
- Can backflow prevention valves be used to minimize flow of floodwater into the water source? \_\_\_ Yes \_\_\_ No

**Figure 5W-3. Flood-Resistant Retrofitting Field Investigation Worksheet (concluded)**

## 5W.7 Design Overview

This section presents the process of designing and implementing measures to retrofit existing building utility systems. Retrofitting may involve a combination of elevating and/or protecting in place. The general design process involved with wet floodproofing is shown in Figure 5W-4.

Elevation and protection in place alternatives for electrical systems, HVAC systems, fuel supply/storage systems, water systems, and sewer systems are discussed in Sections 5W.8 through 5W.12.

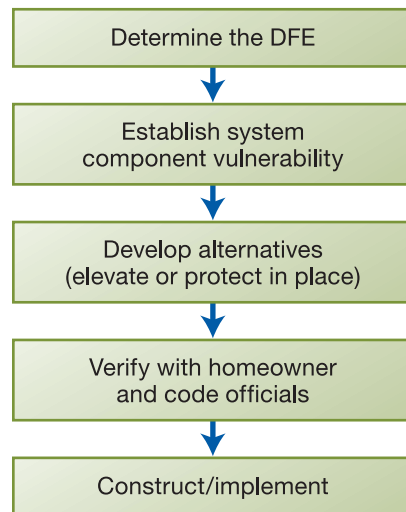

**Figure 5W-4.**  
Wet floodproofing of  
utilities design process



### CROSS REFERENCE

Retrofitting measures, using techniques similar to those discussed in Section 5W.8, should be considered for telephone and cable TV exterior service lines, indoor wiring, outlet jacks, wall plates, etc.

## 5W.8 Electrical Systems

Electrical system components can be seriously damaged by floodwater when either active or inactive. Silt and grit accumulates in devices not rated for complete submergence and destroys the insulation of the device. Current circuit breakers and fuses are designed to protect the wiring conductors and devices from overload situations, including short circuit or ground fault conditions. Floodwater seriously affects operation of these devices.

Most houses were not designed to mitigate potential flood damage to electrical equipment; however, there are retrofitting steps that will provide permanent protection for the electrical system.

- The most important step is to raise or relocate equipment and devices above the DFE.
- A second step is to seal electrical equipment penetrations on outside walls, anchor cables and raceway, and mechanically protect the wiring system in flood-prone locations.
- A third step is to seal out moisture. Electrical system problems occur as moisture permeates devices and causes corrosion.

- A fourth step necessary for retrofitting is the addition of Ground Fault Circuit Interrupter (GFCI) breakers, which deactivate circuits when excessive current leakage is encountered. This step ultimately assists life safety protection and may be required by local codes.
- If it is possible, mount main service lines and the meter to the downstream side of the structure to limit the exposure to debris impact. If service from the distribution lines are underground, it is important to verify that they are buried to a sufficient depth to eliminate them being uncovered by erosion or scour. If possible, mount the meter to above the DFE and sufficiently secure it and the service lines below the DFE to resist flood loads.

Each residence presents the designer with a unique set of characteristics, including age, method of construction, size, and location. There are different combinations of systems that may need to be modified. When it is not feasible to elevate in place, the following information provides the design considerations and details that govern the retrofitting of electrical equipment and circuits below the DFE:

- receptacles and switches should be kept to a minimum and elevated as high as is practical;
- circuit conductors must be Underwriters Laboratories (UL) listed for use in wet locations;
- wiring should be run vertically for drainage after being inundated;
- new wiring should be underground feeder (UF) grade wiring to eliminate the need to replace large portions of wiring behind walls following flooding;
- receptacles and switches should be installed in non-corrosive boxes with holes punched in the bottom to facilitate drying. The receptacles will have to be replaced after inundation by floodwater;
- lighting fixtures should be connected via simple screw base porcelain lampholders to allow speedy removal of lamps or fixtures, and the lampholders can be cleaned and reused;
- sump pumps and generators should have cables long enough to reach grounded receptacles above the DFE;
- all circuits below the DFE should be protected by GFCI breakers;
- circuits serving equipment below the DFE should be placed on separate GFCIs, clearly marked in the breaker box. This allows power to be turned off to circuits below the DFE without affecting the rest of the home; and
- wiring splices below DFE should be kept to a minimum. If conductors must be spliced, use crimp connectors and waterproof with heat shrink tubing or grease packs over the splice.



#### **CROSS REFERENCE**

Additional information on these elements can be obtained from FEMA's NFIP Technical Bulletin 7-93, *Wet Floodproofing Requirements for Structures Located in Special Flood Hazard Areas in Accordance with the National Flood Insurance Program* (FEMA, 1993b).

## 5W.9 Heating, Ventilating, and Air Conditioning Systems

HVAC system equipment (i.e., furnaces, boilers, compressors) should be elevated/relocated above the DFE or protected within a watertight enclosure whenever possible. However, the protection of HVAC system equipment requires consideration of several factors. Some points to consider when evaluating potential retrofitting measures are:

- adequate space and structural support for relocated equipment;
- maintenance of required equipment clearances and maintenance access dictated by code and/or manufacturer;
- provision of adequate combustion air for fuel-burning equipment;
- modification and/or maintenance of proper venting of fuel-burning equipment;
- necessity of non-combustible construction materials;
- necessity of eliminating ductwork below the DFE whenever possible;
- suitability of protective partitions or vaults;
- reconfiguration of ductwork;
- consideration of duct construction material; and
- modification of hot water or steam circulation piping.



### NOTE

In a post-flooding situation, the designer may recommend replacing old equipment with a new one that meets current codes, is more energy/cost-efficient, and fits in the desired location. In some cases, the old equipment may be replaced with lateral or in-line equipment, installed in the attic to protect it from flooding.

## 5W.10 Fuel Supply/Storage Systems

In conjunction with the retrofitting of HVAC equipment, the designer must consider rerouting and/or extending fuel supply lines (i.e., fuel oil, natural gas, and propane gas) when equipment is relocated. Floodwater can pull poorly anchored tanks off their foundations (see Figure 5W-5) and result in damages and the potential spill of toxic liquids. In order to prevent damaged fuel supply or storage tanks, the following should be considered with respect to fuel supply/storage systems:

- extension of fuel supply lines to relocated equipment;
- use of flexible connections;
- adequate support and anchorage to resist hydrostatic and hydrodynamic forces that act on tanks. This can be accomplished by:
  - elevating tanks on structural fill;
  - elevating tanks on a braced platform;



### NOTE

Galvanized steel ductwork is less susceptible than ductboard or similar materials to damage from flooding. Generally, if flooded, ducts made of ductboard are not reusable.

- anchoring tanks to properly install and using designed ground anchors (Figure 5W-6);
- anchoring supply lines to the downstream side of structural members;
- relocating fuel tank because of equipment relocation; and
- using automatic cut-off valves.

**Figure 5W-5.**  
An improperly anchored  
tank; tethered only by a  
supply line



**Figure 5W-6.**  
Fuel tank anchored from  
two sides

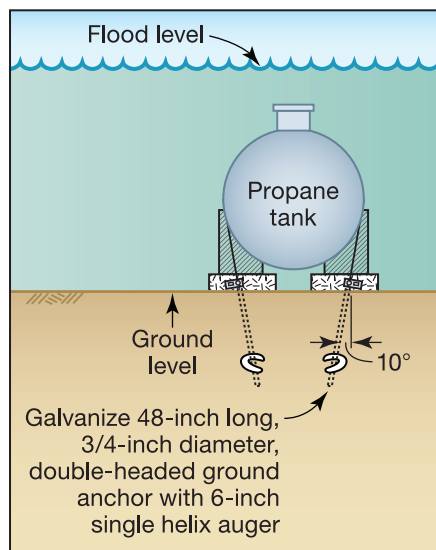



## 5W.11 Water Systems

The primary threats that floodwater poses to water systems are contamination and velocity flow damage. Contamination by floodwater may occur through infiltration into on-site water wells, public water supplies, open faucets, or broken pipes. In flood-prone areas that experience high velocity flow, damage may occur from the effects of the velocity, wave action, and/or debris impact. Some factors to consider when retrofitting water systems include:

- minimization of plumbing fixtures below the DFE;
- allowance of adequate space for elevating components;
- modification of lines and fixtures to prevent backflow;
- protection of system components from high velocity flow;
- suitability of protective partitions or vaults; and
- modification of the well top using watertight casing.



### NOTE

Adequate protection of all fuel, water, sewer pipes, and tanks from damage caused by erosion, scour, buoyancy, debris impact, velocity flow, and wave action should be verified during the retrofitting design process.

## 5W.12 Sewer Systems

The main dangers associated with the flooding of sewer systems are backup of sewage, damage of system components, and contamination of floodwater. Because these dangers could result in serious health risks, preventive measures could help clean-up expenses and hazards. Retrofitting sewer systems to eliminate or minimize the dangers include the following possible options:

- relocation of collection components to a higher elevation;
- installation and/or maintenance of a check or sewer backflow prevention valve;
- installation and/or maintenance of combination check and gate valves (see Figure 5W-7);
- installation of an effluent ejector pump;
- provision of a backup electrical source;
- sealing of septic tank to prevent contamination; and
- adequate anchorage of septic tank to withstand buoyancy forces.



### NOTE

Guidance concerning the anchoring of septic tanks is applicable to other types of underground storage tanks.



### WARNING

When subject to flood forces, ruptured storage tanks containing natural gas, oil, or propane also pose the additional risk of explosion or environmental contamination.

It is important that sanitary sewage storage systems in flood-prone areas are able to prevent contamination during and immediately following a flooding event. In areas where ASCE 24 is enforced, Section 7.3.4 specifically outlines sizing requirements for sealed storage tanks during and after flood



events while the soil is saturated. The guidelines are intended to prevent contamination of the floodwater. Even if ASCE 24 is not a required design standard, it is an appropriate guidance document for sealed sanitary storage tank sizing requirements.

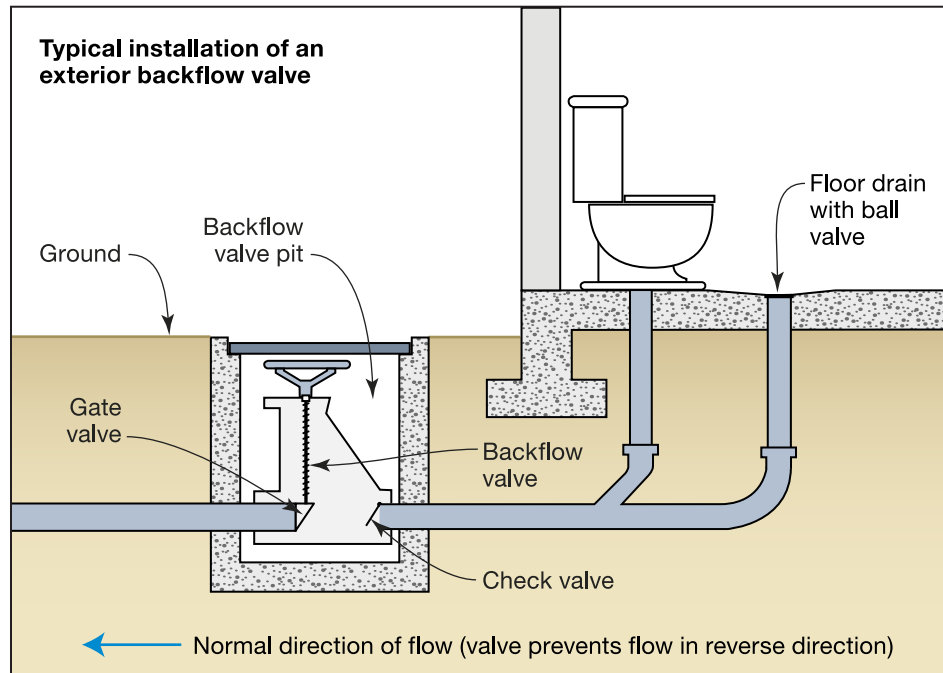

**Figure 5W-7.**  
**Backflow valve – a check valve and gate valve with an effluent pump bypass**  
 SOURCE: FEMA 348, 1999A

### 5W.13 Calculation of Buoyancy Forces

The anchorage of any tank system consists of attaching the tank to a resisting body with enough weight to hold the tank in place. The attachment, or anchors, must be able to resist the total buoyant force acting on the tank. The buoyant force on an empty tank is the volume of the tank multiplied by the specific weight of water. It is usually advisable to include a safety factor of 1.3, as is shown in the net buoyancy force computation in Equation 5W-1.



**NOTE**

To minimize buoyancy forces, fuel tanks should be "topped off" prior to flooding.



**CROSS REFERENCE**

For a more detailed analysis of buoyancy forces, refer to FEMA 348, *Protecting Building Utilities from Flood Damage: Principles and Practices for the Design and Construction of Flood Resistant Building Utility Systems* (FEMA, 1999a)



### EQUATION 5W-1: NET BUOYANCY FORCE ON A TANK

$$F_b = [0.134V_t\gamma_w FS] - W_t \quad (\text{Eq. 5W-1})$$

where:

- $F_b$  = net buoyancy force of the tank (lb)
- $V_t$  = volume of the tank (gal)
- 0.134 = factor to convert gal to ft<sup>3</sup>
- $\gamma_w$  = specific weight of flood water surrounding the tank (generally 62.4 lb/ft<sup>3</sup> for fresh water and 64.0 lb/ft<sup>3</sup> for saltwater)
- $FS$  = factor of safety to be applied to the computation, typically 1.3 for tanks
- $W_t$  = weight of the tank, calculated using an empty tank weight (lb)

The volume of concrete required to offset the buoyant force of the tank can be computed as shown in Equation 5W-2.



### EQUATION 5W-2: CONCRETE VOLUME REQUIRED TO OFFSET BUOYANCY

$$V_c = \frac{F_b}{(S_c - \gamma_w)} \quad (\text{Eq. 5W-2})$$

where:

- $V_c$  = volume of concrete required (ft<sup>3</sup>)
- $F_b$  = net buoyancy force of the tank (lb)
- $S_c$  = effective weight of concrete (typically 150 lb/ft<sup>3</sup>)
- $\gamma_w$  = specific weight of water (62.4 lb/ft<sup>3</sup> for fresh water or 64.0 lb/ft<sup>3</sup> for salt water)

To resist this buoyant force, a slab of concrete with a volume,  $V_c$ , is usually strapped to the tank to resist the buoyant load.

Sample calculations for the net buoyancy force on the tank and concrete volume required to resist buoyancy are available in Appendix C.

## 5W.14 Construction/Implementation

The retrofitting of utility systems, both elevating and protecting in place, must conform to the requirements set forth in local and state building codes, standards, floodplain ordinances, and equipment manufacturer's installation instructions. Building codes may include reference codes and standards. These reference codes typically address electrical, plumbing, and other utility items of work. It is important to verify compliance with each of these reference codes during the design phase and into the construction phase. For material or equipment substitutions, the technical bulletins, FEMA publications, and ASCE 24 referenced in this chapter should be consulted. All applicable permits and inspections should be completed prior to beginning the next phase of the construction.

The successful construction and implementation of wet floodproofing measures should include the use of flood-resistant materials and consider operations and preparedness planning in Section 5W.3.



# 6 Case Studies

This chapter presents case studies based on structural and nonstructural retrofitting measures. The studies illustrate many of the procedures presented in the previous chapters and actual design practices. The cases include scenarios that examine elevation, relocation, dry and wet floodproofing, and small floodwalls and levees.

The case studies that follow are fictionalized scenarios developed to illustrate the retrofit option selection and design process. Narratives, graphics, photos, and calculations are fabricated and not based on actual individuals or structures.

## 6.1 Case Study #1: Residential Retrofit in Riverine Floodplain Using Elevation or Relocation

This case study examines the retrofit of a residential building in a riverine floodplain by means of elevation or relocation. Details are provided in the subsections that follow.

### 6.1.1 Description of Property

Harry S. Truman  
55555 Cedar River Road, Mount Vernon, IA 55555

The Truman family has owned a large plot of land near Mount Vernon, Iowa, since the early 20<sup>th</sup> century. The 200+ acre plot slopes up from the Cedar River to a hilly, wooded area. Their current home, a one-story, wood-frame structure, was built in the 1960s, and is considered pre-FIRM construction. It has experienced varying levels of flooding from the Cedar River since its construction. A sunroom addition was built onto

the back of the structures in the 1980s. The structure is located in the SFHA (100-year floodplain) but, due to the sloping nature of the site, most of the rest of the plot is located outside the SFHA.

Harry Truman, the current owner, has decided that he would like to retrofit his home to resist flood damage. The local floodplain ordinance does not allow elevation on fill, and he does not like the idea of an open foundation. Mr. Truman indicated he would like to pursue retrofitting options that would allow him to obtain a reduced NFIP flood insurance rate. If possible, Mr. Truman would like to apply for HMA grant assistance.

### 6.1.2 Structure Information

55555 Cedar River Road is a one-story, wood-frame structure on a crawlspace and is a structure of good quality (Figure 6-1).

Other structure information includes:

- Footprint: 1,800 square feet
- Foundation:
  - Perimeter crawlspace foundation walls are reinforced and grouted CMU block, 8 inches thick, supported by a 2-foot wide x 1-foot thick reinforced concrete wall footer
  - Twelve interior piers at 10-foot spacing are reinforced and grouted double-stack CMU block, supported by 2-foot x 2-foot x 1-foot footer
  - Perimeter foundation walls and interior piers extend 2 feet below grade to the top of the footers, and 2 feet above grade
  - There are no flood vents in the above-grade portion of the perimeter foundation walls
- Structure:
  - First floor elevation of 694.2 feet (reference NAVD88), measured at the top of the lowest finished floor
  - Top of crawlspace of 692.2 feet (reference NAVD88)
  - Wood-frame structure
  - Wood siding
  - Wood-frame interior walls with gypsum board sheathing
- Roof:
  - Gable roof without overhangs over main structure (40 foot x 40 foot plan area)
  - Flat roof without overhangs over sunroom (10 foot x 20 foot area)
  - Asphalt shingle roof covering over entire roof
- Interior:
  - Wood stud interior walls with gypsum board sheathing
  - Hardwood floors

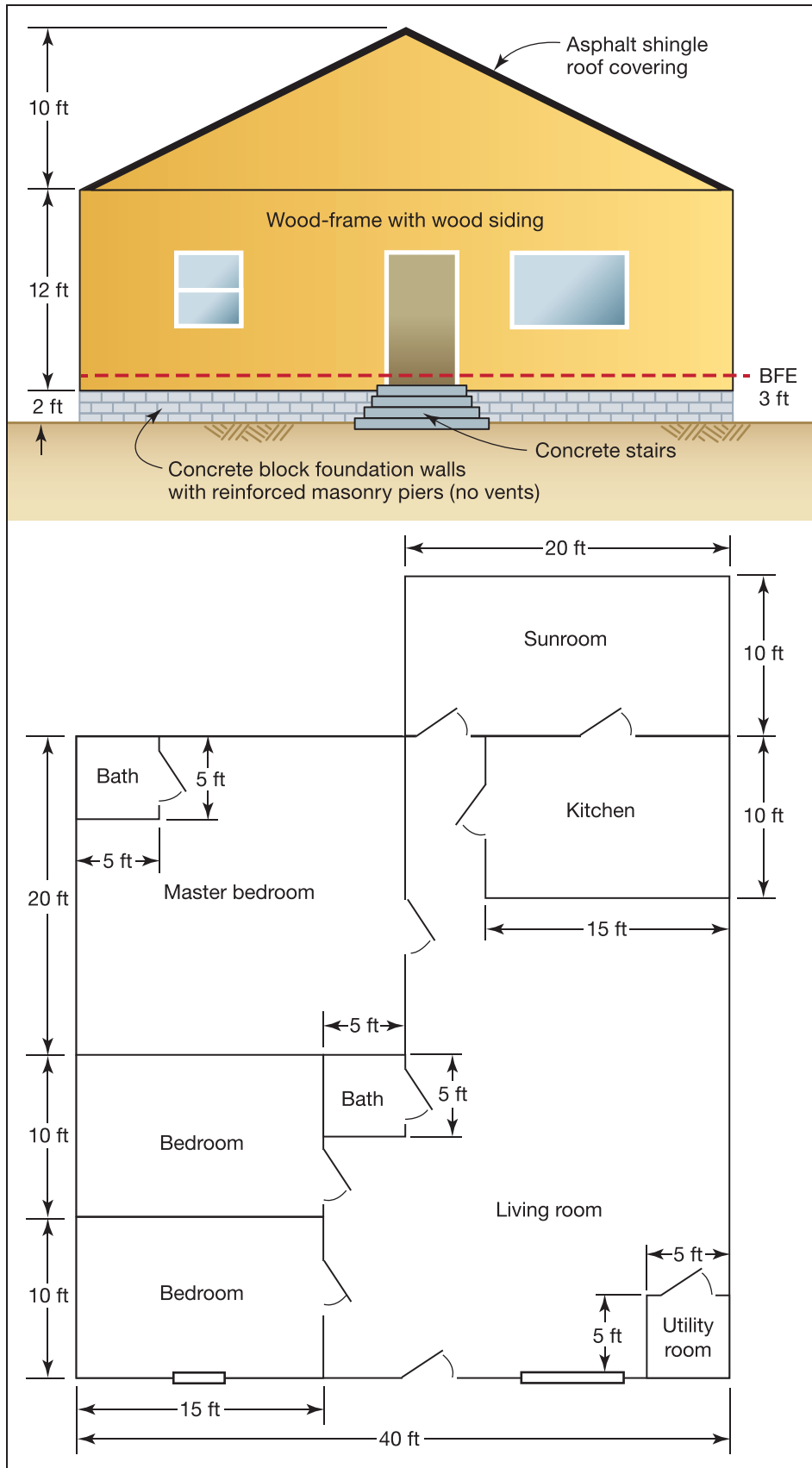

Figure 6-1.  
The Truman house

## Plot

The 200+ acre plot slopes from an elevation of approximately 690 feet near the river to near 730 feet in the woods. The 10-foot contour map shows the approximate size and topography of the plot and is included at the end of this case study. The site soils are primarily a mixture of silty sand and gravel (Soil Type SM).

## Building Assessment

An updated tax card is included at the end of this case study as an alternate source of the building replacement value as well as to verify the building square footage data.

Additionally, an engineer's estimate is that the Truman home has a building replacement value of approximately \$105.00 per square foot, based on popular cost estimating guides.

## Flood Hazard Data

The local floodplain management ordinance applies to all structures in the floodplain. Elevation on fill is prohibited, and a 1-foot freeboard is required for all new construction and substantial improvements.

The structure itself sits at the low point of the property and is in the SFHA, although most of the plot is outside of the regulatory floodplain. The flood map (FIRMette) is included at the end of this case study.

The applicable excerpts from the FIS show the flood elevations and discharges for the existing structure and are included in Section 6.1.5 and summarized in Table 6-1.

**Table 6-1. Summary of Flood Elevations and Discharges for the Truman House**

	Streambed	10-year	50-year	100-year	500-year
Elevation (ft)	671.2	694	696.3	697.8	700
Discharge (cfs)	NA	53,500	77,900	87,900	112,900

cfs = cubic feet per second

Note: All topographic maps and flood hazard data reference NAVD88.

A licensed surveyor filled out the elevation certificate, which references NAVD88 and is included at the end of this case study.









Note that since there are no flood vents, the top of the lowest floor is considered to be the top of the crawlspace floor. In this case, the top of the crawlspace floor is equivalent to the LAG.

The flow velocity under base flood conditions is assumed to be 2.0 ft/sec.

### 6.1.3 Retrofit Options Selection

During an initial interview with Mr. Truman, potential retrofit options were discussed (Figure 6-2). Immediately, elevation on fill was ruled out because it is prohibited by the local floodplain ordinance. Similarly, dry floodproofing, wet floodproofing, and floodwalls and small levees were ruled out because these measures will not bring a pre-FIRM home located in a SFHA into compliance with the NFIP. Therefore, elevation and relocation are viable options for the structure and will reduce NFIP flood insurance rates.



Owner Name: <u>Harry S. Truman</u>		Prepared By: <u>Jane Q. Engineer</u>							
Address: <u>55555 Cedar River Road</u>		Date: <u>9/1/2011</u>							
Property Location: <u>Mount Vernon, Iowa</u>									
Floodproofing Measures									
Considerations									
	Elevation on Foundation Walls	Elevation on Fill	Elevation on Piers	Elevation on Posts and Columns	Elevation on Piles	Relocation	Dry Flood-proofing	Wet Flood-proofing	Floodwalls and Levees
Measure Allowed or Owner Requirement		X					X	X	X
Homeowner Concerns									
Aesthetic Concerns			X	X	X				
High Cost Concerns	X		X	X	X	X			
Risk Concerns									
Accessibility Concerns	X		X	X	X				
Code Required Upgrade Concerns									
Off-Site Flooding Concerns									
Total "X's"	2	NA	3	3	3	1	NA	NA	NA

Instructions: Determine whether a floodproofing measure is allowed under local regulations or homeowner requirement. Put an "x" in the box for each measure that is not allowed. Complete the matrix for only those measures that are allowable (no "x" in the first row). For those measures allowable or owner required, evaluate the considerations to determine if the homeowner has concerns that would affect its implementation. A concern is defined as a homeowner issue that, if unresolved, would make the retrofitting method(s) infeasible. If the homeowner has a concern, place an "x" in the box under the appropriate measure/consideration. Total the number of "x's". The floodproofing measure with the least number of "x's" is the most preferred.

Figure 6-2. Preliminary Floodproofing/Retrofitting Preference Matrix for the Truman house

Cost was a concern for all potential retrofit options. Mr. Truman was also concerned about building accessibility for an elevation project. Mr. Truman was particularly concerned about how his home might look with an open foundation.

Based on the retrofit option screening matrix, the two most viable options were elevation by extending the foundation walls and relocation. Calculations and considerations are provided for both relocation and elevation.

### **Relocation**

The only way to completely eliminate the flood risk to Mr. Truman's home is to move the entire structure out of the SFHA. Because his plot is so large, and ample buildable space exists outside of the SFHA, relocation is a good option to consider. Refer to Table 1-2 of this document for the advantages and disadvantages of relocation. The relocation process would include:

- selecting the new structure site;
- designing, excavating for, and constructing the new foundation;
- installing new utility connections at the new site;
- disconnecting utilities at the existing site;
- lifting the existing structure on hydraulic jacks;
- transporting the structure from the original site to the new site;
- lowering the structure and securing it onto the new foundation ;
- connecting utilities; and
- demolishing and filling the old foundation.

A preliminary cost estimate shows that the cost of relocation would likely be approximately \$120,000. A preliminary BCA shows a BCR of 1.18. Therefore, relocation would be cost-beneficial as well as effective at eliminating future flood damage.

### **Elevation by Extending the Perimeter Foundation Walls**

Elevating the structure on the existing perimeter foundation walls is also a viable retrofit option. Refer to Table 1-1 of this document for the advantages and disadvantages of elevation. The elevation process would include:

- designing the extended foundation;
- disconnecting utilities;
- lifting the existing structure on hydraulic jacks;
- extending the foundation walls;

- installing flood vents;
- lowering the structure;
- reconnecting utilities; and
- constructing a new deck and stairs.

The BFE is 697.8 feet NAVD88, and the first floor elevation (i.e., the top of the lowest floor) is 694.2 feet. The elevation of the LAG is 692.2 feet. The BFE is at a depth of  $697.8 \text{ feet} - 692.2 \text{ feet} = 5.6 \text{ feet}$ . Therefore, the floodproofing depth  $H = 5.6 \text{ feet} + 1 \text{ foot} = 6.6 \text{ feet}$ .

Installing NFIP-compliant flood vents in the foundation walls will ensure that the crawlspace is no longer considered the “lowest floor” and that the lowest floor elevation will actually be the top of the floor of the living area. Because the crawlspace is already 2 feet high, the perimeter walls would only need to be extended an additional 4.6 feet to place the first floor elevation 1 foot above the BFE (i.e., 6.6 feet above the LAG).

A preliminary cost estimate shows a retrofit cost of approximately \$100,000. This cost yields a BCR of 1.08. Therefore, elevation would be effective and cost-beneficial.

The elevated structure would look as shown in Figure 6-3. A hydrostatic force computation worksheet is presented in Figure 6-4.

Note that the concrete staircase has been replaced with wooden stairs that allow water to flow through the base.

To ensure that the foundation is properly designed, the flood forces must be calculated and checked with applicable design loads.

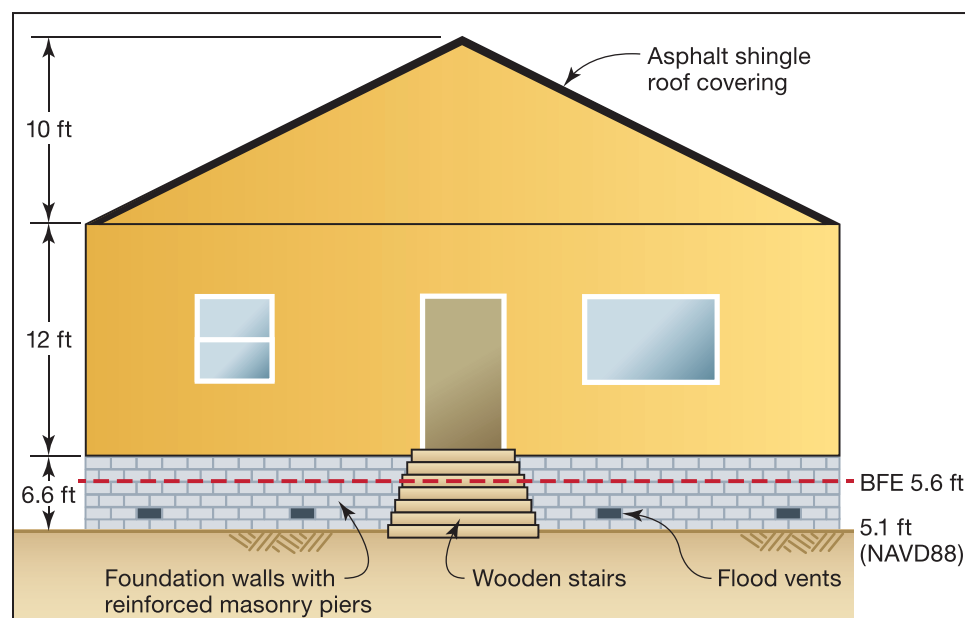

**Figure 6-3.**  
The Truman house after elevation, including extended foundation walls and flood vents

Hydrostatic Force Computation Worksheet			
Owner Name:	Harry S. Truman	Prepared By:	Jane Q. Engineer
Address:	55555 Cedar River Road	Date:	9/1/2011
Property Location:	Mount Vernon, Iowa		
<b>Constants</b>		<b>Summary of Loads</b>	
$\gamma_w$ = specific weight of water = 62.4 lb/ft <sup>3</sup> for fresh water and 64.0 lb/ft <sup>3</sup> for saltwater		$f_{sta}$ = 0 lb/ft	
<b>Variables</b>		$f_{dif}$ = 0 lb/ft	
$H$ = floodproofing design depth (ft) = 6.6 ft		$f_{comb}$ = 0 lb/ft	
$D$ = depth of saturated soil (ft) = 2 ft		$F_{bouy}$ = 135,236 lb	
$S$ = equivalent fluid weight of saturated soil (lb/ft <sup>3</sup> ) = NA			
$Vol$ = volume of floodwater displaced by a submerged object (ft <sup>3</sup> ) = 2,167 ft <sup>3,a</sup>			
<b>Equation 4-4: Lateral Hydrostatic Force</b>			
$f_{sta} = \frac{1}{2}P_b H = \frac{1}{2}\gamma_w H^2 = 0 \text{ lb/ft}$			
<b>Equation 4-5: Submerged Soil and Water Force</b>			
$f_{dif} = \frac{1}{2}(S - \gamma_w)D^2 = 0 \text{ lb/ft}$			
<b>Equation 4-6: Combined Lateral Hydrostatic Force</b>			
$f_{comb} = f_{sta} + f_{dif} = 0 \text{ lb/ft}$			
<b>Equation 4-7: Buoyancy Force</b>			
$F_{bouy} = \gamma_w (Vol) = (62.4 \text{ lb/ft}^3)(2,167 \text{ ft}^3) = 135,236 \text{ lbs}$			

<sup>a</sup> Volume of water displaced is equal to the volume of the foundation walls, footers, floor system, and interior piers:

Walls: Perimeter = 40 ft + 40 ft + 40 ft + 10 ft + 20 ft + 10 ft + 20 ft = 180 ft; height = 4 ft (above grade) + 2 ft (below grade) = 6 ft; thickness = 16 in = 1.33 ft; 6 corners subtract 6(1.33 ft)(1.33 ft)(6 ft) = 63.7 ft<sup>3</sup>; vents: 1 in<sup>2</sup> of open area for 1 ft<sup>2</sup> of enclosed area 1800 in<sup>2</sup> of open area 12.5 ft<sup>2</sup> of open area subtract 1.33 ft \* 12.5 ft<sup>2</sup> = 16.6 ft<sup>3</sup>

$$V_{walls} = (180 \text{ ft})(6 \text{ ft})(1.33 \text{ ft}) - 6(1.33 \text{ ft})(1.33 \text{ ft})(6 \text{ ft}) - (12.5 \text{ ft}^2)(1.33 \text{ ft}) = 1,355.7 \text{ ft}^3$$

Footers: Perimeter = 180 ft; width = 2 ft; thickness = 1 ft; corners subtract 6(2 ft)(2 ft)(1 ft) = 24 ft<sup>3</sup>

$$V_{footers} = (180 \text{ ft})(2 \text{ ft})(1 \text{ ft}) - 6(2 \text{ ft})(2 \text{ ft})(1 \text{ ft}) = 336 \text{ ft}^3$$

Floor: The floor joists and subfloor must be included in Zone A because the top of the lowest floor is at 4 ft. 2 in. x 10 in. floor joists at 16 in. o.c (40 ft x 12 in./ft)/16 in. ≈ 30 joists in main structure. Volume of one joist in main structure = 2 in. x (ft/12 in.) x 10 in. x (ft/12 in.) x 40 ft = 5.56 ft<sup>3</sup>. In sunroom, (20 ft x 12 in./ft)/16 in. = 15 joists. Volume of one joist in sunroom = 2 in. x (ft/12 in.) x 10 in. x (ft/12 in.) x 10 ft = 1.39 ft<sup>3</sup>. Total volume of joists = 30 x 5.56 ft<sup>3</sup> + 15 x 1.39 ft<sup>3</sup> = 187.65 ft<sup>3</sup>. Subfloor 0.5 in. plus 0.25 in. hardwood floor volume of floor = (0.5 in. + 0.25 in.) x (1 ft/12 in.) x 1800 ft<sup>2</sup> = 112.5 ft<sup>3</sup>

$$V_{slab} = 187.65 \text{ ft}^3 + 112.5 \text{ ft}^3 = 300.15 \text{ ft}^3$$

Interior Piers: 12 piers. Each 16 in<sup>2</sup>, 6 ft tall with a 2 ft x 2 ft x 1 ft footer.

$$V_{piers} = 12(1.33 \text{ ft})(1.33 \text{ ft})(6 \text{ ft}) + 12(2 \text{ ft})(2 \text{ ft})(1 \text{ ft}) = 175.4 \text{ ft}^3$$

$$V_{water} = V_{walls} + V_{footers} + V_{slab} + V_{piers} = 1,355.7 \text{ ft}^3 + 336 \text{ ft}^3 + 300.15 \text{ ft}^3 + 175.4 \text{ ft}^3 = 2,167 \text{ ft}^3$$

Figure 6-4. Hydrostatic Force Computation Worksheet for the elevated Truman house (refer to Figure 4-9)

## 6.1.4 Load Calculations

The following paragraphs provide calculations for flood loads, dead loads, live loads, and load combinations, as well as bearing capacity, sliding, uplift, and overturning checks associated with the elevation option.

### Load Calculations: Flood Loads

The first step is to calculate hydrostatic forces. As determined above, the floodproofing depth  $H$  is 4 feet. The perimeter wall extends 2 feet underground and is supported by a 1-foot-deep footer; therefore, the saturated soil depth  $D$  (measured from the ground surface to the top of the footer) is 2 feet (see Figure 4-8). Because openings were installed in the crawlspace, there are no hydrostatic forces.

The flow velocity is 2.0 ft/sec. An equivalent hydrostatic force computation worksheet is presented in Figure 6-5.

Equivalent Hydrostatic Force Computation Worksheet			
Owner Name: _____	Harry S. Truman	Prepared By: _____	Jane Q. Engineer
Address: _____	55555 Cedar River Road	Date: _____	9/1/2011
Property Location: _____	Mount Vernon, Iowa		
<b>Constants</b>		<b>Summary of Loads</b>	
$\gamma_w$ = specific weight of water = 62.4 lb/ft <sup>3</sup> for fresh water and 64.0 lb/ft <sup>3</sup> for saltwater		$f_{db}$ = 40.0 lb/ft	
$g$ = acceleration of gravity = 32.2 ft/sec <sup>2</sup>		$f_{sta}$ = 0 lb/ft	
<b>Variables</b>		$f_{dif}$ = 0 lb/ft	
$H$ = design floodproof depth (ft) = 6.6 ft		$f_{comb}$ = 19.38 lb/ft	
$V$ = velocity of floodwater (10 ft/sec or less) = 2 ft/sec			
$P_{db}$ = hydrostatic pressure due to low velocity flood flows = (lb/ft <sup>2</sup> )			
$b$ = width of structure perpendicular to flow (ft) = 40 ft			
<b>Equation 4-8: Conversion of Low Velocity Flood Flow to Equivalent Head</b>			
$dh = \frac{C_d V^2}{2g} = (1.25)(2 \text{ ft/sec})^2 / (2)(32.2 \text{ ft/sec}^2) = 0.0776 \text{ ft}$			
Develop $C_d$ : $b/H = 40 \text{ ft} / 4 \text{ ft} = 10$ From Table 4-5; $C_d = 1.25$			
<b>Equation 4-9: Conversion of Equivalent Head to Equivalent Hydrostatic Force</b>			
$f_{db} = \gamma_w (dh)H = P_{db}H = (62.4 \text{ lb/ft}^3)(0.0776 \text{ ft})(6.6 \text{ ft}) = 40.0 \text{ lb/ft}$			
<b>Equation 4-10: Combined Lateral Hydrostatic Force</b>			
$f_{comb} = f_{sta} + f_{dif} + f_{db} = 0 \text{ lb/ft} + 0 \text{ lb/ft} + 40.0 \text{ lb/ft}$			

Figure 6-5. Equivalent Hydrostatic Force Computation Worksheet for the Truman house (refer to Figure 4-11)

The design flood depth is 4 feet; therefore,  $C_D = 0.75$ .  $C_B = 1.0$ . An impact force computation worksheet is presented in Figure 6-6.

Impact Force Computation Worksheet			
Owner Name: _____	Harry S. Truman	Prepared By: _____	Jane Q. Engineer
Address: _____	55555 Cedar River Road	Date: _____	9/1/2011
Property Location: _____	Mount Vernon, Iowa		
<b>Variables</b>		<b>Summary of Loads</b>	
$W$ = weight of the object (lb) = 1,000 lbs		$F_i$ = 1,200 lbs	
$V$ = velocity of water (ft/sec) = 2 ft/sec			
$C_D$ = depth coefficient (see Table 4-6) = 0.75			
$C_B$ = blockage coefficient (taken as 1.0 for no upstream screening, flow path greater than 30 feet; see Table 4-7 for more information)			
$C_{Str}$ = building structure coefficient			
= 0.2 for timber pile and masonry column supported structures 3 stories or less in height above grade			
= 0.4 for concrete pile or concrete or steel moment resisting frames 3 stories or less in height above grade			
= 0.8 for reinforced concrete foundation walls (including insulated concrete forms)			
Equation 4-13: Normal Impact Loads			
$F_i = W V C_D C_B C_{Str} = (1000 \text{ lbs})(2 \text{ ft/sec})(0.75)(1)(0.8) = 1,200 \text{ lbs}$			

Figure 6-6. Impact Force Computation Worksheet for the Truman house (refer to Figure 4-12)

Flood Force Summary:

*Horizontal Force:*

$$f_{comb} = 40.0 \text{ lb/lf}$$

$$F_i = 1,200 \text{ lbs}$$

The total flood force acting on the front wall (perpendicular to flow) is:

$$F = (40.0 \text{ lb/lf})(40 \text{ ft}) + 1,200 \text{ lbs} = 2,800 \text{ lbs}$$

*Vertical Force:*

$$F_{buoy} = 135,236 \text{ lbs}$$

### Load Calculations: Dead Loads

The dead load is the self-weight of the structure. Table 6-2 illustrates the dead load calculations using the conservative unit weights listed in Chapter 4 as well as a less conservative approach.

Table 6-2. Summary of Dead Load Calculations for the Truman House

Element	Area (ft <sup>2</sup> )	Chapter 4 Unit Weight (lb/ft <sup>2</sup> )	Chapter 4 Total Weight (lbs)
Exterior walls: drywall, 4 in. batt insulation, wood siding	$(4)(40\text{ ft})(12\text{ ft}) + (2)(10\text{ ft})(12\text{ ft}) = 2,160$	11	23,760
Interior walls: wood stud, 2 ft x 4 ft, ½ in. drywall	$(12)(5+5+20+20+15+10+10+5+5+10+15+10) = 1,560$	8	12,480
Floor frame: wood frame, 2 ft x 10 ft interior, unfinished floor	1,800	10	18,000
Floor cover: hardwood	1,800	3	5,400
Ceiling: drywall	1,800	10	18,000
Roof: sloping timbers, sheathing, 10 in. batt insulation	$(2)(40)(102 + 202)1/2 + (10)(20) = 1,992^a$	15	29,880
Roof cover: asphalt shingles	1,992	4	7,968
<b>TOTAL</b>	<b>Over the 1,800 ft<sup>2</sup> structure</b>	<b>61</b>	<b>115,488</b>

<sup>a</sup> Roof area is taken to be the area of the sloping sections of the roof, calculated as twice the area of one side of the roof. Each side of the roof is taken to be rectangular, with dimensions of 40 ft (along the base) and  $[(10)^2 + (20)^2]^{1/2} = 22.4$  ft (the hypotenuse of the triangle formed by the vertical section of the roof structure).

<sup>b</sup> Foundation walls are considered to be a single layer, reinforced CMU wall (8-in. thick) with a unit weight of 75 lb/ft<sup>2</sup>. Walls after mitigation extend 4 ft above ground and 2 ft below ground. The area is therefore  $[4(40\text{ ft})(6\text{ ft})] - [4(0.67\text{ ft})(6\text{ ft})]$  (to account for corners) = 944 ft<sup>2</sup>.

<sup>c</sup> Foundation piers are considered to be double stack, reinforced CMU piers (16 in. x 16 in.). The unit weight of a 16-in. thick pier is taken to be twice the unit weight of an 8-in. thick reinforced CMU pier. The area is therefore  $12(1.333\text{ ft})(6\text{ ft}) = 96\text{ ft}^2$ .

<sup>d</sup> Unit weights for reinforced concrete are given in lb/ft<sup>3</sup>. The footing volume is taken to be  $[4(40\text{ ft})(2\text{ ft})(1\text{ ft})] - [4(2\text{ ft})(1\text{ ft})(1\text{ ft})] = 312\text{ ft}^3$ .

<sup>e</sup> See (d). The interior footing volume is taken to be  $12(2\text{ ft})(2\text{ ft})(1\text{ ft}) = 48\text{ ft}^3$ .

### Load Calculations: Live Loads

#### Live Load (Vertical)

Per ASCE 7-10, assume a live load of:

$$L = 40\text{ lb/ft}^2 \times (1,800\text{ ft}^2) = 72,000\text{ lbs}$$

#### Roof Live Load (Vertical)

Per ASCE 7-10, assume a roof live load of 20 lb/ft<sup>2</sup>. The roof live load acts on the horizontal projected area of the roof:

$$L_r = 20\text{ lb/ft}^2 \times (1,800\text{ ft}^2) = 36,000\text{ lbs}$$

#### Snow Load (Vertical)

Assume a conservative snow load of 20 lb/ft<sup>2</sup>, per ASCE 7-10. The snow load also acts on the horizontal projected area of the roof.

$$S = 20\text{ lb/ft}^2 (1,800\text{ ft}^2) = 36,000\text{ lbs}$$



*Wind Load (Horizontal)*

Appendix C contains a detailed discussion of wind load calculations, including a detailed example. Refer to Appendix C for wind load calculations; this case study uses a simplified approach. Using a simplified wind load, assuming that the structure is fully enclosed, assume a worst case scenario wind load acting perpendicular to the structure (i.e., on the entire face of the structure facing the river). Because the roof at the front (windward side) of the house is sloped and there are no overhangs, there is no vertical wind (uplift) component. Therefore, assume a wind pressure of 30 lb/ft<sup>2</sup> acting uniformly over the entire aboveground structure:

$$\begin{aligned} \text{Area} &= \text{Elevated Crawlspace area} + \text{Exterior Wall area} + \text{Vertical Roof area} \\ \Rightarrow A &= (4 \text{ ft})(40 \text{ ft}) + (12 \text{ ft})(40 \text{ ft}) + (10 \text{ ft})(40 \text{ ft}) = 160 \text{ ft}^2 + 480 \text{ ft}^2 + 400 \text{ ft}^2 = 1040 \text{ ft}^2 \\ W &= 30 \text{ lb/ft}^2 \times (1,040 \text{ ft}^2) = 31,200 \text{ lbs} \end{aligned}$$

*Earthquake Load*

Earthquake forces are assumed to be negligible for this location. Therefore,  $E = 0$ .

**Load Combinations**

To determine the worst-case horizontal and vertical loading scenarios, ASCE 7-10 load combinations are used (Allowable Stress Design). Table 6-3 presents a summary of the horizontal and vertical load combinations.

Load Summary:

*Horizontal Loads*

$$\begin{aligned} D &= L = L_r = S = E = 0 \\ F_a &= F_{comb} = 2,800 \text{ lbs} \\ W &= 31,200 \text{ lbs} \end{aligned}$$

**Table 6-3. Summary of Horizontal and Vertical Load Combinations for the Truman House**

Combination	Horizontal (lbs)	Vertical (lbs)
1. $D$	0	115,560
2. $D + L$	0	187,560
3. $D + (L_r \text{ or } S \text{ or } R)$	0	151,560
4. $D + 0.75L + 0.75(L_r \text{ or } S \text{ or } R)$	0	196,560
5. $D + (0.6W \text{ or } 0.7E) + 0.75F_a$	20,820	14,133
6a. $D + 0.75L + 0.75(0.6W) + 0.75(L_r \text{ or } S \text{ or } R) + 0.75F_a$	16,140	95,133
6b. $D + 0.75L + 0.75(0.7E) + 0.75S + 0.75F_a$	2,100	95,133
7. $0.6D + 0.6W + 0.75F_a$	20,820	-32,091
8. $0.6D + 0.7E$	0	69,336

*Vertical Loads*

$$D = 115,560 \text{ lbs}$$

$$L = 72,000 \text{ lbs}$$

$$L_r = 36,000 \text{ lbs}$$

$$S = 36,000 \text{ lbs}$$

$$W = 0 \text{ (conservative)}$$

$$E = 0$$

$$F_a = F_{buoy} = 135,236 \text{ lbs}$$

**Bearing Capacity Check**

$$P_{max} = A_{bearing} S_{bc}$$

$$S_{bc} = 2,500 \text{ lb/ft}^2 \text{ (Table 5-2)}$$

The bearing area is the area of the footings:

$$A_{bearing} = [4 (40 \text{ ft})(2 \text{ ft})] - [4 (2 \text{ ft})(2 \text{ ft})] + [12(2 \text{ ft})(2 \text{ ft})] = 352 \text{ ft}^2$$

$$P_{max} = (2,500 \text{ lb/ft}^2)(352 \text{ ft}^2) = 880,000 \text{ lbs}$$

Maximum vertical load:

$$335,688 \text{ lbs} < P_{max} \checkmark$$

**Sliding Check**

The soil type is SM; from IBC 2009 (Table 1806.2), the coefficient of friction is 0.25. Worst case horizontal load combination 7:  $0.6D + 0.6W + 0.75F_a$

Horizontal Resistive Force = Foundation Resistive Force + Resistive Force from Structure Self-Weight

Foundation Resistive Force  $r = (k_p)(\gamma_{soil})(d^2/2)$ , where:

$$k_p = \tan^2(45^\circ + \phi/2), \text{ where } \phi \text{ is the soil angle of internal friction (assume } \phi = 30^\circ)$$

$$k_p = \tan^2(45^\circ + 30^\circ/2) = 3$$

$$\gamma_{soil} = 77 \text{ lb/ft}^3 \text{ (Soil Type SM; see Table 4-3)}$$

$$d = \text{depth of soil from top of soil to top of footer} = 2 \text{ ft}$$

$$\text{Therefore, } r = (3)(77 \text{ lb/ft}^3)(2 \text{ ft})^2/2 = 462 \text{ lb/ft}$$

Assume both side walls of the main structure resist sliding, therefore,

$$R_H = 2(40 \text{ ft})(462 \text{ lb/ft}) = 36,960 \text{ lbs}$$

$$\text{Resistive Force from Structure Self Weight} = 0.25 (0.6D) = 0.25 \times 0.6 (115,560 \text{ lbs}) = 17,334 \text{ lbs}$$

$$\text{Total Resistive Force} = 36,960 \text{ lbs} + 17,334 \text{ lbs} = 54,294 \text{ lbs}$$

$$\text{Horizontal Load} = 0.6W + 0.75F_a = 20,820 \text{ lbs} < 38,203 \text{ lbs} \checkmark$$

Figure 6-7 presents the moment diagram for the Truman house.

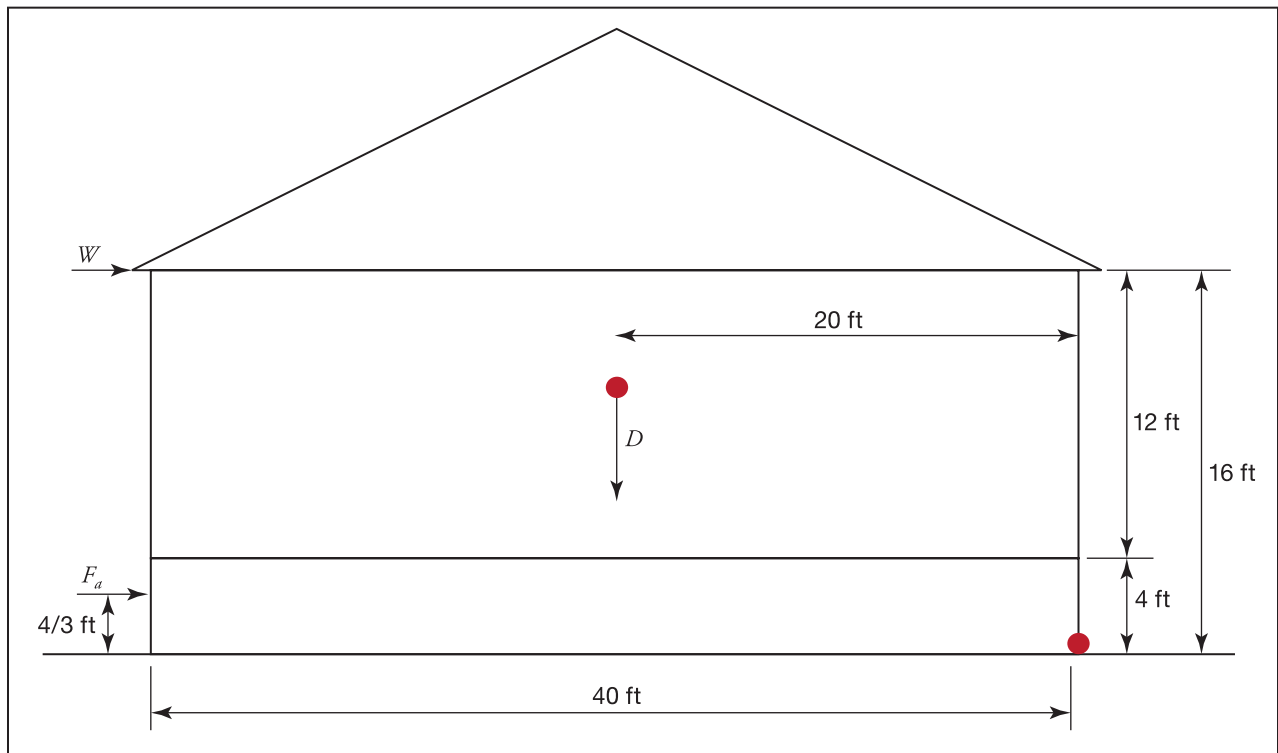

Figure 6-7. Moment diagram for the Truman house

### Uplift Check

The worst case load combination for the uplift check would be  $0.6D + 0.6W + 0.75F_a$ .

The resistive force is equal to the weight of the concrete footer and soil above the footer that would need to be uprooted. Assuming a soil angle of internal friction of  $\phi = 30^\circ$ , a cross section of the displaced soil and footer is as follows in Figure 6-8:

Figure 6-8. Cross section of displaced soil and footer

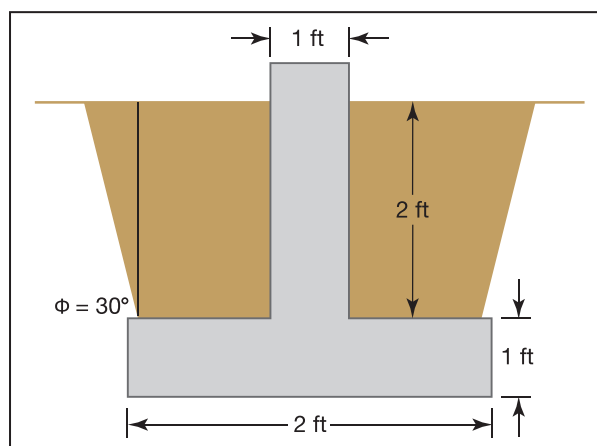

To calculate the weight of the displaced concrete and soil, calculate the volume displaced. The perimeter of the house is given by  $(40 \text{ ft} \times 3 + 20 \text{ ft} + 10 \text{ ft} + 20 \text{ ft} + 10 \text{ ft}) = 180 \text{ ft}$ .

The volume of the foundation walls is given by:

$$V_{walls} = (180 \text{ ft} \times 2 \text{ ft} \times 1 \text{ ft}) - 6(2 \text{ ft} \times 1 \text{ ft}) = 348 \text{ ft}^3$$

The volume of the footers is given by:

$$V_{footer} = (180 \text{ ft} \times 1 \text{ ft} \times 2 \text{ ft}) - 6(1 \text{ ft} \times 2 \text{ ft}) = 348 \text{ ft}^3$$

The total volume of concrete is:  $V_{concrete} = 348 \text{ ft}^3 + 348 \text{ ft}^3 = 696 \text{ ft}^3$

The total weight of concrete is:  $W_{concrete} = 150 \text{ lb/ft}^3 \times 696 \text{ ft}^3 = 104,400 \text{ lbs}$

The cross-section of the displaced soil is given by the area of the trapezoid of soil failure minus the area of the wall. The smaller base of the trapezoid is 2 feet. The angle of internal friction is  $30^\circ$ , therefore the wider base of the trapezoid is  $2 \text{ feet} + 2[2\tan(30^\circ)] = 4.3 \text{ feet}$ . Therefore the cross-sectional area of the displaced soil is:

$$A_{soil} = (2 \text{ ft} + 4.3 \text{ ft}) \times 2 \text{ ft} / 2 - 2 \text{ ft} \times 1 \text{ ft} = 4.3 \text{ ft}^2$$

The volume of displaced soil is given by:

$$V_{soil} = (180 \text{ ft} \times 4.3 \text{ ft}^2) - 6(4.3 \text{ ft}^2) = 748.2 \text{ ft}^3$$

The total weight of soil is:  $W_{soil} = 77 \text{ lb/ft}^3 \times 748.2 \text{ ft}^3$ .

Therefore, the total resistive force is:  $R_v = 104,400 \text{ lbs} + 57,611 \text{ lbs} = 162,011 \text{ lbs}$

Vertical uplift =  $0.6W + 0.75F_a = 101,427 \text{ lbs} < 162,011 \text{ lbs} \checkmark$

### Overturning Check

$$M_W = (16 \text{ ft})W = 499,200 \text{ ft-lbs}$$

$$M_F = -(20 \text{ ft})F_V + -(4/3 \text{ ft})F_H = -2,708,453 \text{ ft-lbs}$$

$$0.6M_W + 0.75M_F = (0.6)(+499,200 \text{ ft-lbs}) + (0.75)(-2,708,453) = -1,731,820 \text{ ft-lbs}$$

$$M_D = (20 \text{ ft})D = 2,311,200 \text{ ft-lbs}$$

$$0.6M_D = 1,386,720 \text{ ft-lbs}$$

$$M_{Rv} = (20 \text{ ft})R_v = 3,240,220 \text{ ft-lbs}$$

$$0.6M_W + 0.75M_F < 0.6M_D + M_{Rv} \checkmark$$

## 6.1.5 Supporting Documentation

This section includes additional information about the Truman house. The following maps and documents provide backup documentation for the values used in the Case Study 1 calculations, including:

- topographic map showing the location of the plot and ground elevation (Figure 6-9);
- FIRMette showing the location of the plot relative to the SFHA (Figure 6-10);
- summary of discharges, excerpted from the FIS, showing the 10-, 50-, 100-, and 500-year discharges at the Truman house (Figure 6-11);
- flood profile showing the 10-, 50-, 100-, and 50-year flood elevations at the Truman house (Figure 6-12);

- elevation certificate showing the first floor elevation (Figure 6-13);
- tax card providing building value and square footage (Figure 6-14); and
- BCA report excerpt summarizing the cost-effectiveness of elevation and relocation (Figure 6-15).



Figure 6-9. Topographic map showing the location of the Truman plot (in red). Please note these are 10-foot contours.

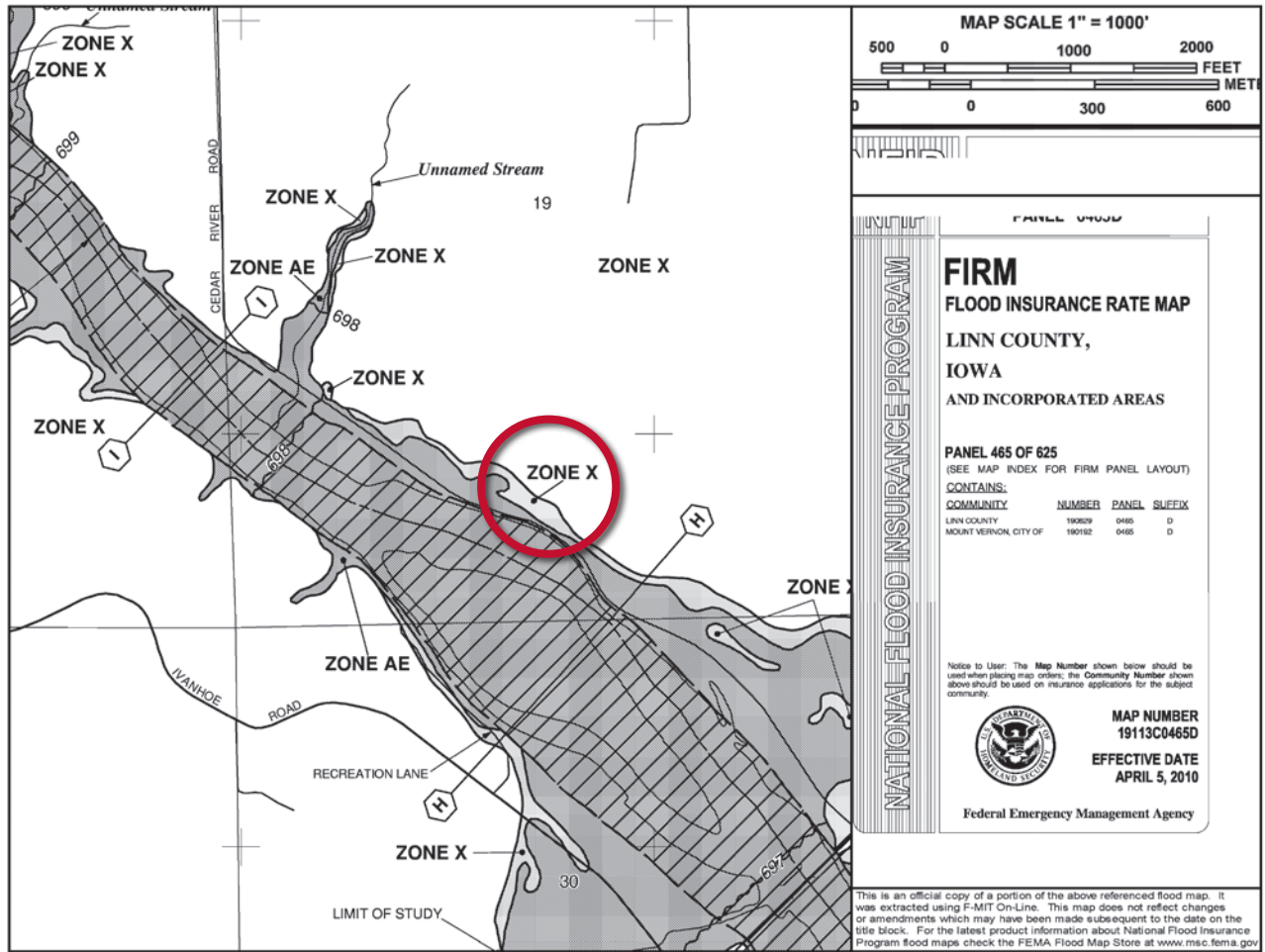

Figure 6-10. FIRM showing the location of the Truman plot (circled in red)



**TABLE 3 – SUMMARY OF DISCHARGES**

<u>Flooding Source and Location</u>	<u>Drainage Area Sq. Miles</u>	<u>Peak Discharges (CFS)</u>			
		<u>10% Annual Chance</u>	<u>2% Annual Chance</u>	<u>1% Annual Chance</u>	<u>0.2% Annual Chance</u>
<b>CEDAR CREEK</b>					
At south county boundary	6987	52800	78000	88000	112000
At State Highway 1 bridge	6974	53500	77900	87900	112900
Just upstream of confluence of Big Creek	6844	53200	77700	87700	112700
Just upstream of confluence of Morgan Creek	6458	53500	78100	88100	113100
At the gaging station in Cedar Rapids at 7 <sup>th</sup> Avenue SW	6510	53000	77000	87000	112000
Just upstream of confluence of Otter Creek	6381	53700	78400	88400	113400
Just upstream of confluence of Opossum Creek	6243	53800	78500	88600	113600
<b>WAPSIPINICON RIVER</b>					
At south county boundary	1324	18350	30520	36000	49220
Just above confluence of Heatons Creek	1294	18090	30080	35480	48500
Just above confluence of Waltons Creek	1242	17810	29620	34940	47760
<b>MARTINS CREEK</b>					
At mouth	4.2	1255	2485	3152	4995
Just upstream of small tributary in the northwest quarter of Section 14, T83N, R6W	3.5	1225	2410	3055	4830
Just upstream of small tributary in the northwest quarter of Section 11, T83N, R6W	2.2	1010	2010	2565	4105

Figure 6-11. FIS Excerpt: Discharge table for the Truman house (applicable discharges circled in red)



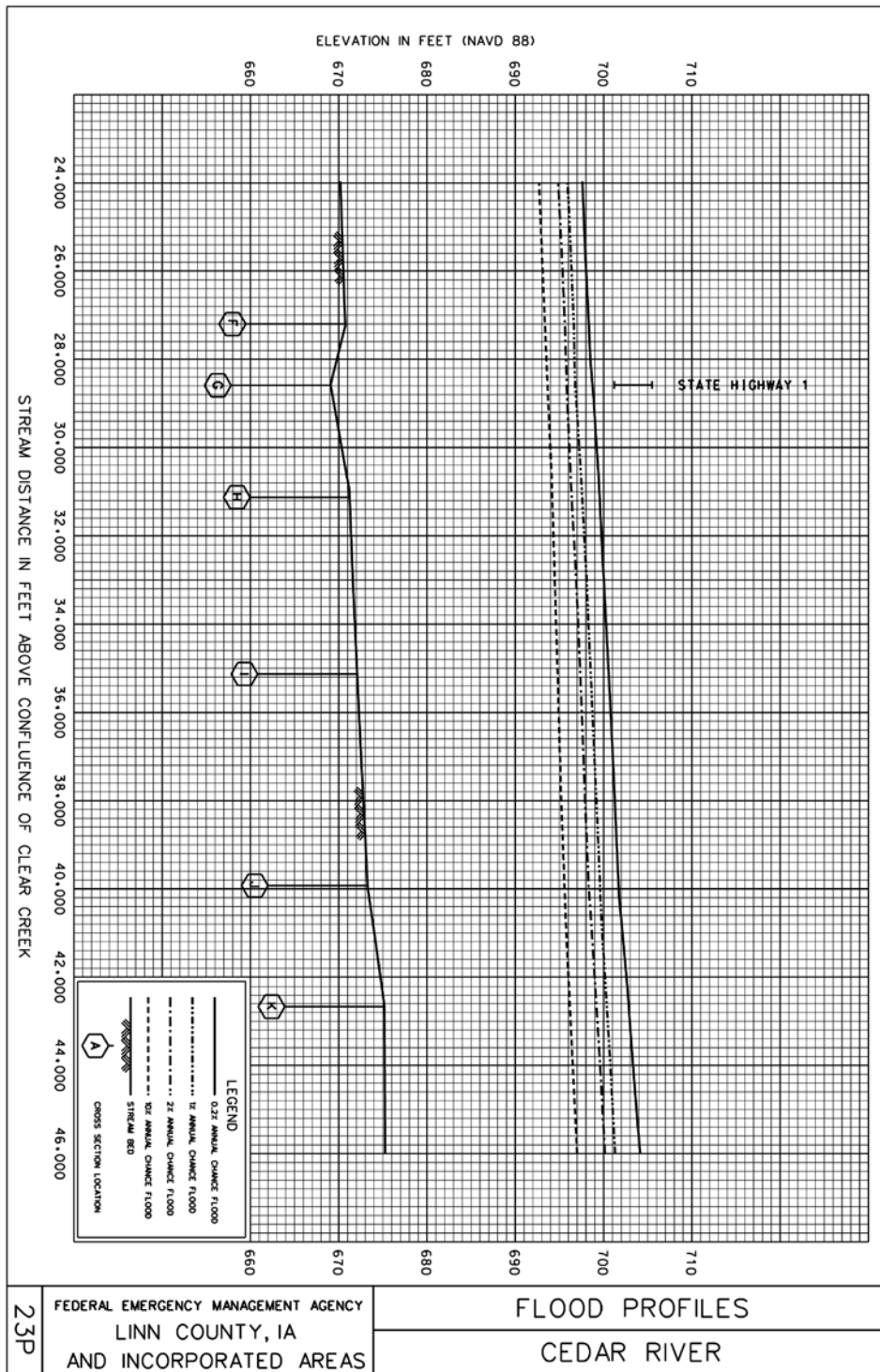

Figure 6-12. FIS excerpt: Flood profile for the Truman house

U.S. DEPARTMENT OF HOMELAND SECURITY  
Federal Emergency Management Agency  
National Flood Insurance Program

## ELEVATION CERTIFICATE

Important: Read the instructions on pages 1-9.

OMB No. 1660-0008  
Expires March 31, 2012

---

**SECTION A - PROPERTY INFORMATION**

A1. Building Owner's Name Samuel Klayman

A2. Building Street Address (including Apt., Unit, Suite, and/or Bldg. No.) or P.O. Route and Box No.  
55555 Cedar River Road  
City Mount Vernon State IA ZIP Code 55555

A3. Property Description (Lot and Block Numbers, Tax Parcel Number, Legal Description, etc.)  
NA

A4. Building Use (e.g., Residential, Non-Residential, Addition, Accessory, etc.) Residential

A5. Latitude/Longitude: Lat. NA Long. NA Horizontal Datum:  NAD 1927  NAD 1983

A6. Attach at least 2 photographs of the building if the Certificate is being used to obtain flood insurance.

A7. Building Diagram Number 8

A8. For a building with a crawlspace or enclosure(s):  
 a) Square footage of crawlspace or enclosure(s) 1800 sq ft  
 b) No. of permanent flood openings in the crawlspace or enclosure(s) within 1.0 foot above adjacent grade 0  
 c) Total net area of flood openings in A8.b 0 sq in  
 d) Engineered flood openings?  Yes  No

A9. For a building with an attached garage:  
 a) Square footage of attached garage \_\_\_\_\_ sq ft  
 b) No. of permanent flood openings in the attached garage within 1.0 foot above adjacent grade \_\_\_\_\_  
 c) Total net area of flood openings in A9.b \_\_\_\_\_ sq in  
 d) Engineered flood openings?  Yes  No

For Insurance Company Use:

Policy Number \_\_\_\_\_

Company NAIC Number \_\_\_\_\_

---

**SECTION B - FLOOD INSURANCE RATE MAP (FIRM) INFORMATION**

B1. NFIP Community Name & Community Number <u>19113C</u>		B2. County Name <u>Linn County</u>		B3. State <u>IA</u>	
B4. Map/Panel Number <u>465</u>	B5. Suffix <u>D</u>	B6. FIRM Index Date <u>April 5, 2010</u>	B7. FIRM Panel Effective/Revised Date <u>April 5, 2010</u>	B8. Flood Zone(s) <u>AE</u>	B9. Base Flood Elevation(s) (Zone AO, use base flood depth) <u>697.8</u>

B10. Indicate the source of the Base Flood Elevation (BFE) data or base flood depth entered in Item B9.  
 FIS Profile  FIRM  Community Determined  Other (Describe) \_\_\_\_\_

B11. Indicate elevation datum used for BFE in Item B9:  NGVD 1929  NAVD 1988  Other (Describe) \_\_\_\_\_

B12. Is the building located in a Coastal Barrier Resources System (CBRS) area or Otherwise Protected Area (OPA)?  Yes  No  
 Designation Date \_\_\_\_\_  CBRS  OPA

---

**SECTION C - BUILDING ELEVATION INFORMATION (SURVEY REQUIRED)**

C1. Building elevations are based on:  Construction Drawings\*  Building Under Construction\*  Finished Construction  
 \*A new Elevation Certificate will be required when construction of the building is complete.

C2. Elevations – Zones A1-A30, AE, AH, A (with BFE), VE, V1-V30, V (with BFE), AR, AR/A, AR/AE, AR/A1-A30, AR/AH, AR/AO. Complete Items C2.a-h below according to the building diagram specified in Item A7. Use the same datum as the BFE.  
 Benchmark Utilized \_\_\_\_\_ Vertical Datum NAVD 88  
 Conversion/Comments \_\_\_\_\_

Check the measurement used.

a) Top of bottom floor (including basement, crawlspace, or enclosure floor) 694.2  feet  meters (Puerto Rico only)

b) Top of the next higher floor 696.2  feet  meters (Puerto Rico only)

c) Bottom of the lowest horizontal structural member (V Zones only) \_\_\_\_\_  feet  meters (Puerto Rico only)

d) Attached garage (top of slab) \_\_\_\_\_  feet  meters (Puerto Rico only)

e) Lowest elevation of machinery or equipment servicing the building (Describe type of equipment and location in Comments) 696.2  feet  meters (Puerto Rico only)

f) Lowest adjacent (finished) grade next to building (LAG) 694.2  feet  meters (Puerto Rico only)

g) Highest adjacent (finished) grade next to building (HAG) 694.5  feet  meters (Puerto Rico only)

h) Lowest adjacent grade at lowest elevation of deck or stairs, including structural support 694.2  feet  meters (Puerto Rico only)

---

**SECTION D - SURVEYOR, ENGINEER, OR ARCHITECT CERTIFICATION**

This certification is to be signed and sealed by a land surveyor, engineer, or architect authorized by law to certify elevation information. I certify that the information on this Certificate represents my best efforts to interpret the data available. I understand that any false statement may be punishable by fine or imprisonment under 18 U.S. Code, Section 1001.

Check here if comments are provided on back of form. Were latitude and longitude in Section A provided by a licensed land surveyor?  Yes  No

Certifier's Name <u>Jane Q. Engineer</u>	License Number <u>5555555</u>
Title <u>Project Engineer</u>	Company Name <u>Engineering Co, Inc</u>
Address <u>555 Main Street</u>	City <u>Springfield</u> State <u>IA</u> ZIP Code <u>55555</u>
Signature _____	Date _____ Telephone <u>555-555-5555</u>

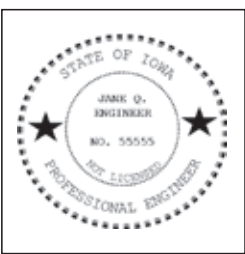

FEMA Form 81-31, Mar 09

See reverse side for continuation.

Replaces all previous editions

Figure 6-13. Elevation certificate excerpt for the Truman house

LINN COUNTY ASSESSOR				
Pin	55555-55555-55555			
Deed	TRUMAN HARRY S			
Property Address	55555 CEDAR RIVER RD MT VERNON			
Class	RESIDENTIAL			
Current Value Information				
Land Value	Dwelling Value	Improvement Value	Total Value	
1,434,098	163,795	0	1,597,893	
Prior Year Value Information				
Year	Land Value	Dwelling Value	Improvement Value	Total Value
2011	1,434,098	163,795	0	1,597,893
2010	1,434,098	163,795	0	1,597,893
2009	1,434,098	163,795	0	1,597,893
2008	1,434,098	163,795	0	1,597,893
2007	1,434,098	163,795	0	1,597,893
Residential Building Information				
Occupancy	Style	Year Built	Total Living Area	
Single-Family/Owner Occupied	1 Story Frame	1964	1,800	
Yard Extra Information				
Description	Item Count	Year Built		
NA				
Land Information				
Lot Basis	Square Feet	Acres		
Lump Sum	9,280,000	213		
Tax History Information				
Tax Year	Assessed Value	Taxable Value	Gross Tax	Net Tax
2009	1,597,893	748,564	23,363	23,363
2008	1,597,893	728,462	20,791	20,600
2007	1,597,893	704,354	20,244	19,200
2006	1,356,789	618,145	17,533	17,000

Figure 6-14. Truman house tax card

16 Sep 2011	Project: <b>Case Study 1</b>	Pg 1 of 21
Total Benefits: <b>\$246,241</b>	Total Costs: <b>\$220,000</b>	BCR: <span style="border: 1px solid black; padding: 2px;">1.12</span>
Project Number:	Disaster #:	Program:
State: <b>Iowa</b>	Point of Contact: Harry Truman	Agency: <b>City of Mount Vernon</b>
		Analyst:

**Project Summary:**

Project Number: \_\_\_\_\_ Disaster #: \_\_\_\_\_  
 Program: \_\_\_\_\_ Agency: City of Mount Vernon  
 Analyst: \_\_\_\_\_

Point of Contact: Harry Truman Phone Number: \_\_\_\_\_  
 Address: 55555 Cedar River Rd, Mount Vernon, Iowa, 55555  
 Email: \_\_\_\_\_  
 Comments: \_\_\_\_\_

**Structure Summary For:**

1-Elevation, 55555 Cedar River Road, Mount Vernon, Iowa, 55555, Linn

Structure Type: Building Historic Building: No Contact: \_\_\_\_\_  
 Benefits: \$105,211 Costs: \$100,000 BCR: 1.05

Mitigation	Hazard	BCR	Benefits	Costs
Elevation	Flood	1.05	\$105,211	\$100,000

2-Relocation, 55555 Cedar River Road, Mount Vernon, Iowa, 55555, Linn

Structure Type: Building Historic Building: No Contact: \_\_\_\_\_  
 Benefits: \$141,030 Costs: \$120,000 BCR: 1.18

Mitigation	Hazard	BCR	Benefits	Costs
Acquisition	Flood	1.18	\$141,030	\$120,000

Figure 6-15. Sample BCA report excerpt for the Truman house elevation and relocation projects

### 6.1.6 Real World Examples

Although the Truman house is fictional, elevation and relocation are both commonly used flood mitigation measures. Figures 6-16 and 6-17 are examples of real structures that have been protected using the mitigation measures discussed in this case study.

This structure was relocated to another property.



Figure 6-16.  
Relocation of an existing  
building to another  
location

This home was elevated on solid foundation walls in Louisiana.



Figure 6-17.  
Elevation of an existing  
home above the BFE

## 6.2 Case Study #2: Residential Retrofit in Coastal A Zone Using Elevation or Acquisition

This case study exercise examines the retrofit of a residential building in a coastal floodplain by means of elevation or acquisition. Details are provided in the subsections that follow.

### 6.2.1 Description of Property

Abe and Bea Chester  
1234 Bay Street, Norfolk, VA 12345

Abe and Bea Chester built their home in the 1960s before flood maps were developed for the area. The one-story, wood-frame structure does not have a basement. They live on Bay Street, close to the beach, in Norfolk, VA. Although they live outside of Zone V, they are still in the SFHA (Zone A) and would like to protect their home from flooding. They are not interested in moving the house itself, but they may be willing to move out of the neighborhood if they can get money to purchase another house. Because they live in Zone A and are subject to coastal flooding, they are interested in elevation on an open foundation. The local floodplain ordinance prohibits elevation on fill. The effective BFE is 4 feet above the first floor elevation.

The Chesters indicated they would like to pursue retrofitting options that would allow them to obtain a reduced NFIP flood insurance rate. If possible, the Chesters would like to apply for HMA grant assistance.

### 6.2.2 Structure Information

1234 Bay Street is a one-story, wood-frame structure and is a structure of average quality (Figure 6-18). See Section 6.2.5 for a tax card, including a floor plan of the structure.

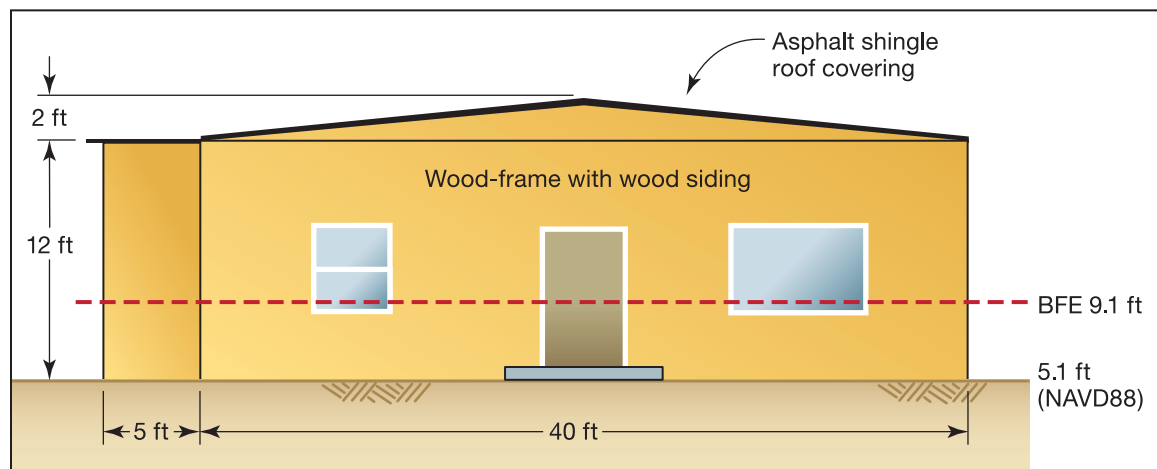

Figure 6-18. The Chester house, before mitigation



Other structure information includes:

- Footprint:
  - 1,025 square feet (see section 6.2.5)
- Foundation:
  - 6-inch-thick concrete slab on a 2-foot-wide x 1-foot-thick concrete wall footer
- Structure:
  - First floor elevation of 5.1 feet NAVD88, measured from the top of the lowest finished floor
  - Wood-frame structure
  - Wood siding
  - Wood-frame interior walls with gypsum board sheathing
- Roof:
  - Gable roof without overhangs over main structure (35-foot x 25-foot plan area)
  - Flat roof without overhangs over side areas (two 5-foot x 15-foot areas)
  - Asphalt shingle roof covering over entire roof
- Interior:
  - Wood stud interior walls with gypsum board sheathing
  - Hardwood floor coverings

### Plot

The Chesters' plot is essentially flat and relatively small. The entire plot is in the SFHA. The ground elevation is between 5.1 feet and 5.3 feet (NAVD88) over the entire plot. The site soils are primarily a mixture of silty sand and gravel (Soil Type SM).

### Building Assessment

An updated tax card is included at the end of this case study as an alternate source of the building replacement value as well as to verify the building square footage data.

Additionally, an engineer's estimate is that the Chesters' home has a building replacement value of approximately \$80 per square foot, based on popular cost estimating guides.



### Flood Hazard Data

The local floodplain management ordinance applies to all structures in the SFHA. Elevation on fill is strictly prohibited, and a 1-foot freeboard is required for all new construction and substantial improvements. The flood map (FIRMette) is included in Section 6.2.5 to document the flood hazard data used below.

The applicable excerpts from the FIS show the flood elevations and the BFE for the existing structure and are included in Section 6.2.5. Table 6-4 shows the stillwater elevations and BFE of the property.

**Table 6-4. Stillwater Elevations for the Chester House**

Stillwater Elevations (ft)				
BFE	10-year	50-year	100-year	500-year
9.1	5.5	6.9	7.6	8.9

Note: All topographic maps and flood hazard data reference NAVD88.

A licensed surveyor filled out the elevation certificate, which references NAVD88 and is included at the end of this case study.

The base flood flow velocity is assumed to be 3.0 feet per second.

### 6.2.3 Retrofit Options Selection

During an initial interview with the Chesters, potential retrofit options were discussed (Figure 6-19). Immediately, elevation on fill was ruled out because it is prohibited by the local floodplain ordinance. Similarly, dry floodproofing, wet floodproofing, and floodwalls and small levees were ruled out because these measures will not bring a pre-FIRM home located in a SFHA into compliance with the NFIP. Therefore, acquisition (not included in matrix) and elevation were viable options for the structure and will reduce NFIP flood insurance rates.









Cost was a concern for all potential retrofit options. The Chesters were also concerned about building accessibility for an elevation project.

Based on the retrofit option screening matrix, the two most viable options were elevation on piers and acquisition/demolition.

#### Acquisition

The only way to completely eliminate the risk to the Chesters' home is to move the entire structure out of the SFHA. Because the Chesters aren't interested in this, but are willing to move, acquiring the house and demolishing it may be a viable option. The acquisition process would include:

- Using HMA or other funds to purchase the home from the Chesters
- Demolishing the existing structure
- Restoring the site to green space
- Maintaining the site as green space

Owner Name: <u>Abe and Bea Chester</u>		Prepared By: <u>Jane Q. Engineer</u>							
Address: <u>1234 Bay Street</u>		Date: <u>9/1/2011</u>							
Property Location: <u>Norfolk, VA</u>									
Floodproofing Measures									
Considerations									
	Elevation on Foundation Walls	Elevation on Fill	Elevation on Piers	Elevation on Posts and Columns	Elevation on Piles	Relocation	Dry Flood-proofing	Wet Flood-proofing	Floodwalls and Levees
Measure Allowed or Owner Requirement		X				X	X	X	X
Homeowner Concerns									
Aesthetic Concerns	X		X	X	X				
High Cost Concerns			X	X	X				
Risk Concerns	X		X	X					
Accessibility Concerns	X		X	X	X				
Code Required Upgrade Concerns									
Off-Site Flooding Concerns	X								
Total "X's"	4	NA	4	4	3	NA	NA	NA	NA

Instructions: Determine whether a floodproofing measure is allowed under local regulations or homeowner requirement. Put an "x" in the box for each measure that is not allowed. Complete the matrix for only those measures that are allowable (no "x" in the first row). For those measures allowable or owner required, evaluate the considerations to determine if the homeowner has concerns that would affect its implementation. A concern is defined as a homeowner issue that, if unresolved, would make the retrofitting method(s) infeasible. If the homeowner has a concern, place an "x" in the box under the appropriate measure/consideration. Total the number of "x's". The floodproofing measure with the least number of "x's" is the most preferred.

Figure 6-19. Preliminary Floodproofing/Retrofitting Preference Matrix for the Chester house

A preliminary cost estimate shows that the cost of acquisition would be approximately equal to the market value of the structure, plus \$15,000 for demolition and title fees. Based on the tax card (at the end of this case study), the 2011 market value of the structure and land is \$127,461. Based on a total cost of \$142,461, the BCR is 1.25 (see Section 6.2.5). Therefore, acquisition and demolition would be a cost-beneficial retrofit option.

### Elevation on Pile Foundation

If the Chesters decide that they are not interested in moving, elevating on timber piles may be a viable retrofit option. Because the Chesters live in a Coastal A Zone, piers and columns may not be appropriate because of hydrodynamic forces. Refer to Table 1-1 for the advantages and disadvantages of elevation. The elevation process would include:

- Designing the new pile foundation system
- Disconnecting utilities
- Lifting the existing structure on hydraulic jacks and moving it to install piles
- Demolishing the existing foundation
- Driving new piles
- Moving the structure back, lowering the structure, and connecting it to the piles
- Reconnecting utilities

The BFE is 9.1 feet, and the LAG and top of the finished first floor are both 5.1 feet. Including the required 1 foot of freeboard, the floodproofing depth  $H$  is  $(9.1 - 5.1 + 1.0) = 5$  feet. Because the Chesters may want to use the empty space below their newly elevated house for parking, building access, or storage, they may choose to elevate the first floor to 8 feet rather than 5 feet.

A preliminary cost estimate shows a retrofit cost of approximately \$175,000. Therefore, the BCR is 0.86 (see Section 6.2.5). Consequently, elevation on piles as designed is not cost effective. The Chesters may decide not to pursue this option, or they may decide to alter the elevation design to lower costs. For illustrative purposes, load calculations for elevation on piles (as described) are shown in the following sections.

The elevated structure would look as shown in Figure 6-20.

The timber pile plan for the elevated structure is shown in Figure 6-21.

To ensure that the foundation is properly designed, the flood forces must be calculated and checked with other applicable loads.

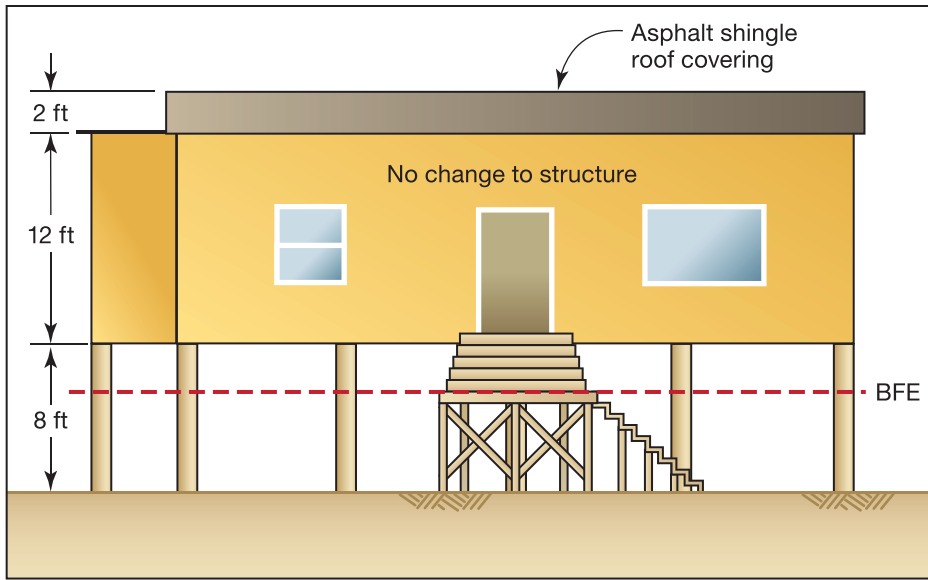

Figure 6-20. The Chester house, after mitigation

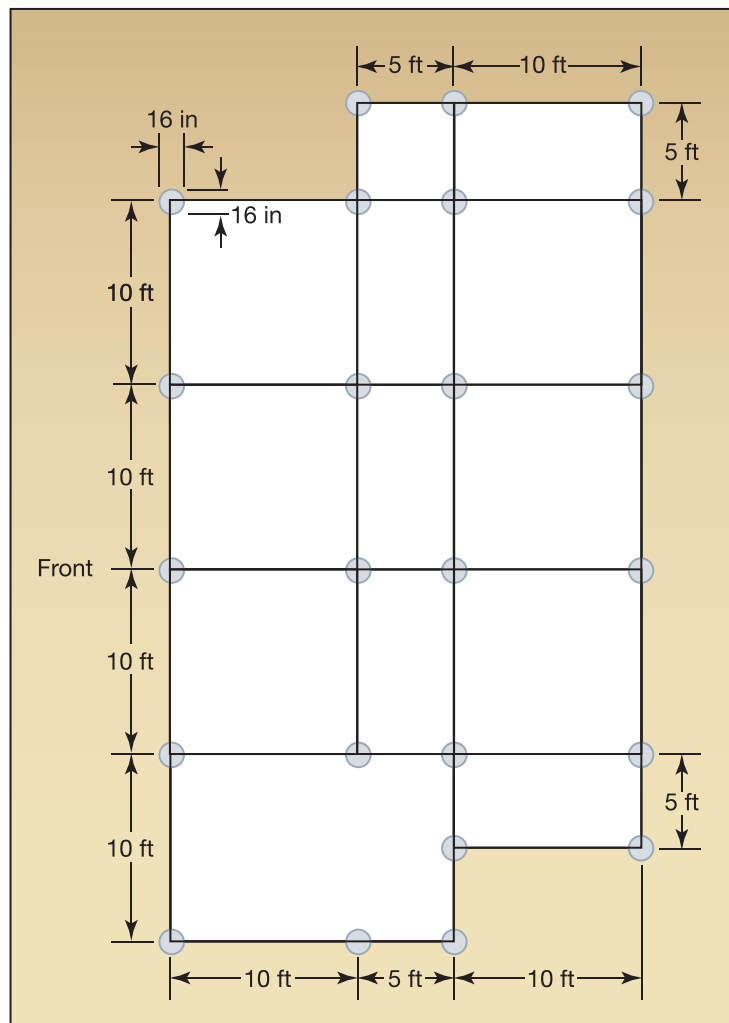

Figure 6-21. Timber pile plan for the elevated Chester house

## 6.2.4 Load Calculations

The paragraphs that follow provide calculations for flood loads, dead loads, live loads, and load combinations associated with the elevation option.

### Load Calculations: Flood Loads

The first step is to calculate hydrostatic forces. As determined above, the floodproofing depth  $H$  is 5 feet. Because the home is being elevated on an open foundation, the saturated soil depth is 0 feet. Because the home is being elevated on an open foundation, and because it is being supported on piles, no lateral hydrostatic or hydrodynamic forces are acting on the structure. Further, vertical hydrostatic (buoyancy) forces will be negligible.

The design flood depth is 5 feet, therefore  $C_D = 1.00$ . Assume  $C_B = 1.0$ . An impact force computation worksheet is presented in Figure 6-22.

Hydrostatic Force Computation Worksheet	
Owner Name: <u>Abe and Bea Chester</u>	Prepared By: <u>Jane Q. Engineer</u>
Address: <u>1234 Bay Street</u>	Date: <u>9/1/2011</u>
Property Location: <u>Norfolk, VA</u>	
<b>Variables</b>	<b>Summary of Loads</b>
$W$ = weight of the object (lbs) = 1,000 lbs	$f_i = 600$ lb
$V$ = velocity of water (ft/sec) = 3 ft/sec	
$C_D$ = depth coefficient (see Table 4-6) = 1.00	
$C_B$ = blockage coefficient (taken as 1.0 for no upstream screening, flow path greater than 30 ft; see Table 4-7 for more information)	
$C_{Str}$ = building structure coefficient	
= 0.2 for timber pile and masonry column supported structures 3 stories or less in height above grade	
= 0.4 for concrete pile or concrete or steel moment resisting frames 3 stories or less in height above grade	
= 0.8 for reinforced concrete foundation walls (including insulated concrete forms)	
<b>Equation 4-13: Normal Impact Loads</b>	
$F_i = W V C_D C_B C_{Str} = (1,000 \text{ lbs})(3 \text{ ft/sec})(1.0)(1.0)(0.2) = 600 \text{ lbs}$	

Figure 6-22. Impact Force Computation Worksheet for the Chester house (Refer to Figure 4-12)

Flood Force Summary:

*Horizontal Force:*

$$f_{comb} = 0 \text{ lb/lf}$$

$$F_i = 600 \text{ lbs}$$

The total flood force acting on the six piers of the front wall (perpendicular to flow) is:

$$F = 600 \text{ lbs}$$

*Vertical Force:*

$$F_{buoy} = 0 \text{ lbs}$$

### Load Calculations: Dead Loads

The dead load is the self-weight of the structure. Case Study #1 illustrates a detailed calculation of the dead load. For this case study, assume a dead weight of approximately 50 lb/ft<sup>2</sup> over 1,025 square feet.

$$D = 50 \text{ lb/ft}^2 \times (1,025 \text{ ft}^2) = 51,250 \text{ lbs}$$

### Load Calculations: Live Loads

*Live Load (Vertical)*

Per ASCE 7-10, assume a live load of:

$$L = 40 \text{ lb/ft}^2 \times (1,025 \text{ ft}^2) = 41,000 \text{ lbs}$$

*Roof Live Load (Vertical)*

Per ASCE 7-10, assume a roof live load of 20 lb/ft<sup>2</sup>. The roof live load acts on the horizontal projected area of the roof:

$$L_r = 20 \text{ lb/ft}^2 \times (1,025 \text{ ft}^2) = 20,500 \text{ lbs}$$

*Snow Load (Vertical)*

Assume a conservative snow load of 20 lb/ft<sup>2</sup>, per ASCE 7-10. The snow load also acts on the horizontal projected area of the roof.

$$S = 20 \text{ lb/ft}^2 (1,025 \text{ ft}^2) = 20,500 \text{ lbs}$$

*Wind Load (Horizontal)*

Appendix C contains a detailed discussion of wind load calculations, including a detailed example. Refer to Appendix C for wind load calculations; this case study uses a simplified approach. Using a simplified wind load, assuming that the structure is fully enclosed, assume a worst case scenario wind load acting perpendicular to the structure (i.e., on the entire face of the structure facing the river). Because the roof at the front (windward side) of the house is sloped and there are no overhangs, there is no vertical wind (uplift) component on the roof. There may be some uplift on the bottom of the structure, but it is not considered here. Therefore, assume a wind pressure of 30 lb/ft<sup>2</sup> acting uniformly over the entire aboveground structure:

$$\begin{aligned} \text{Area} &= \text{Pier surface area (6 piers)} + \text{Exterior Wall area} + \text{Vertical Roof area} \\ \Rightarrow A &= (6)(16 \text{ in.}/(12 \text{ in.}/\text{ft}))(5\text{ft}) + (45 \text{ ft})(16 \text{ ft}) + (1/2)(2 \text{ ft})(40 \text{ ft}) = 40 \text{ ft}^2 + 720 \text{ ft}^2 + 40 \text{ ft}^2 = 800 \text{ ft}^2 \\ W &= 30 \text{ lb}/\text{ft}^2 \times (800 \text{ ft}^2) = 24,000 \text{ lbs} \end{aligned}$$

*Earthquake Load*

Seismic forces are not considered for this example. Therefore,  $E = 0$ .

**Load Combinations**

IBC section 1810.1 requires that deep foundations be designed on the basis of a detailed geotechnical analysis. For that reason, failure modes are not analyzed here. For illustrative purposes, ASCE 7-10 load combinations (Allowable Stress Design) are presented in Table 6-5.

**Table 6-5. Summary of Horizontal and Vertical Load Combinations for the Chester House**

Combination	Horizontal (lbs)	Vertical (lbs)
1. $D$	0	51,250
2. $D + L$	0	92,250
3. $D + (L_r \text{ or } S \text{ or } R)$	0	71,750
4. $D + 0.75L + 0.75(L_r \text{ or } S \text{ or } R)$	0	97,375
5. $D + (0.6W \text{ or } 0.7E) + 0.75F_a$	14,850	51,250
6a. $D + 0.75L + 0.75(0.6W) + 0.75(L_r \text{ or } S \text{ or } R) + 0.75F_a$	11,250	97,375
6b. $D + 0.75L + 0.75(0.7E) + 0.75S + 0.75F_a$	450	97,375
7. $0.6D + 0.6W + 0.75F_a$	14,850	30,750
8. $0.6D + 0.7E$	0	30,750

Load Summary:

*Horizontal Loads*

$$\begin{aligned} D &= L = L_r = S = E = 0 \\ F_a &= F_{sta} = 600 \text{ lbs} \\ W &= 24,000 \text{ lbs} \end{aligned}$$

*Vertical Loads*

$$\begin{aligned} D &= 51,250 \text{ lbs} \\ L &= 41,000 \text{ lbs} \\ L_r &= 20,500 \text{ lbs} \\ S &= 20,500 \text{ lbs} \\ W &= 0 \text{ (conservative)} \\ E &= 0 \\ F_a &= F_{buoy} = 0 \end{aligned}$$



## 6.2.5 Supporting Documentation

This section includes additional information about the Chester house. The following maps and documents provide backup documentation for the values used in the Case Study 2 calculations, including:

- topographic map showing the location of the plot and ground elevation (Figure 6-23);
- DFIRM excerpt showing the location of the Chester house relative to the SFHA (Figure 6-24);
- elevation certificate showing the first floor elevation and BFE (Figure 6-25);
- tax card providing building value and square footage (Figure 6-26); and
- BCA report excerpt summarizing the cost effectiveness of elevation and acquisition (Figure 6-27).



Figure 6-23. Topographic map for the Chester house (general location in red circle)

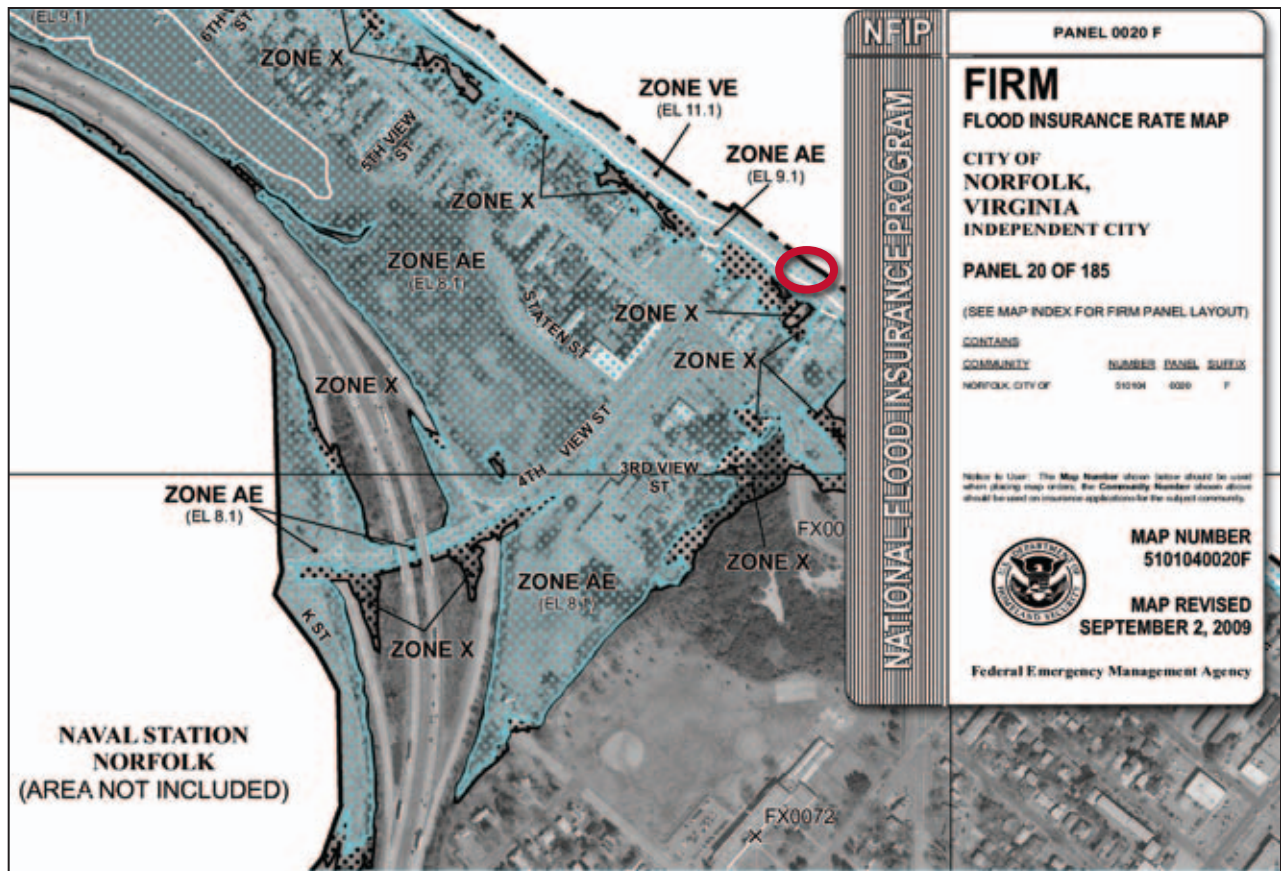

TABLE 1 - SUMMARY OF STILLWATER ELEVATIONS

Flood Source and Location	Elevation (Feet) NAVD 88			
	10-Percent-Annual-Chance	2-Percent-Annual-Chance	1-Percent-Annual-Chance	0.2-Percent-Annual-Chance
Chesapeake Bay and Tributaries Entire shoreline within community	5.5	6.9	7.6	8.9
Little Creek From the east corporate limits to approximately 0.3 mile west of the east corporate limits	5.6	7.2	7.8	9.2
From approximately 0.3 mile west of the east corporate limits and remaining shoreline	5.5	6.9	7.6	8.9
Mason Creek Entire shoreline	4.5	5.6	6.1	7.4

Figure 6-24. DFIRM excerpt and FIS excerpt: Summary of stillwater elevations for the Chester house

U.S. DEPARTMENT OF HOMELAND SECURITY  
Federal Emergency Management Agency  
National Flood Insurance Program

### ELEVATION CERTIFICATE

OMB No. 1660-0008  
Expires March 31, 2012

Important: Read the instructions on pages 1-9.

SECTION A - PROPERTY INFORMATION		For Insurance Company Use:
A1. Building Owner's Name Abe and Bea Chester		Policy Number
A2. Building Street Address (including Apt., Unit, Suite, and/or Bldg. No.) or P.O. Route and Box No. 1234 Bay Street		Company NAIC Number
City Norfolk State VA ZIP Code 1234		

A3. Property Description (Lot and Block Numbers, Tax Parcel Number, Legal Description, etc.)

A4. Building Use (e.g., Residential, Non-Residential, Addition, Accessory, etc.) \_\_\_\_\_

A5. Latitude/Longitude: Lat. \_\_\_\_\_ Long. \_\_\_\_\_ Horizontal Datum:  NAD 1927  NAD 1983

A6. Attach at least 2 photographs of the building if the Certificate is being used to obtain flood insurance.

A7. Building Diagram Number \_\_\_\_\_

A8. For a building with a crawlspace or enclosure(s):

a) Square footage of crawlspace or enclosure(s) \_\_\_\_\_ sq ft

b) No. of permanent flood openings in the crawlspace or enclosure(s) within 1.0 foot above adjacent grade \_\_\_\_\_

c) Total net area of flood openings in A8.b \_\_\_\_\_ sq in

d) Engineered flood openings?  Yes  No

A9. For a building with an attached garage:

a) Square footage of attached garage \_\_\_\_\_ sq ft

b) No. of permanent flood openings in the attached garage within 1.0 foot above adjacent grade \_\_\_\_\_

c) Total net area of flood openings in A9.b \_\_\_\_\_ sq in

d) Engineered flood openings?  Yes  No

#### SECTION B - FLOOD INSURANCE RATE MAP (FIRM) INFORMATION

B1. NFIP Community Name & Community Number Norfolk, VA 510104		B2. County Name NA		B3. State VA	
B4. Map/Panel Number 0020	B5. Suffix F	B6. FIRM Index Date 9/2/2009	B7. FIRM Panel Effective/Revised Date	B8. Flood Zone(s) AE	B9. Base Flood Elevation(s) (Zone AO, use base flood depth) 9.1

B10. Indicate the source of the Base Flood Elevation (BFE) data or base flood depth entered in Item B9.  
 FIS Profile  FIRM  Community Determined  Other (Describe) \_\_\_\_\_

B11. Indicate elevation datum used for BFE in Item B9:  NGVD 1929  NAVD 1988  Other (Describe) \_\_\_\_\_

B12. Is the building located in a Coastal Barrier Resources System (CBRS) area or Otherwise Protected Area (OPA)?  Yes  No  
Designation Date \_\_\_\_\_  CBRS  OPA

#### SECTION C - BUILDING ELEVATION INFORMATION (SURVEY REQUIRED)

C1. Building elevations are based on:  Construction Drawings\*  Building Under Construction\*  Finished Construction  
\*A new Elevation Certificate will be required when construction of the building is complete.

C2. Elevations – Zones A1-A30, AE, AH, A (with BFE), VE, V1-V30, V (with BFE), AR, AR/A, AR/AE, AR/A1-A30, AR/AH, AR/AO. Complete Items C2.a-h below according to the building diagram specified in Item A7. Use the same datum as the BFE.  
Benchmark Utilized \_\_\_\_\_ Vertical Datum NAVD88  
Conversion/Comments \_\_\_\_\_

Check the measurement used.

a) Top of bottom floor (including basement, crawlspace, or enclosure floor) -4.1  feet  meters (Puerto Rico only)

b) Top of the next higher floor 5.1  feet  meters (Puerto Rico only)

c) Bottom of the lowest horizontal structural member (V Zones only) \_\_\_\_\_  feet  meters (Puerto Rico only)

d) Attached garage (top of slab) \_\_\_\_\_  feet  meters (Puerto Rico only)

e) Lowest elevation of machinery or equipment servicing the building (Describe type of equipment and location in Comments) -4.1  feet  meters (Puerto Rico only)

f) Lowest adjacent (finished) grade next to building (LAG) 4.8  feet  meters (Puerto Rico only)

g) Highest adjacent (finished) grade next to building (HAG) 5.3  feet  meters (Puerto Rico only)

h) Lowest adjacent grade at lowest elevation of deck or stairs, including structural support \_\_\_\_\_  feet  meters (Puerto Rico only)

#### SECTION D - SURVEYOR, ENGINEER, OR ARCHITECT CERTIFICATION

This certification is to be signed and sealed by a land surveyor, engineer, or architect authorized by law to certify elevation information. I certify that the information on this Certificate represents my best efforts to interpret the data available. I understand that any false statement may be punishable by fine or imprisonment under 18 U.S. Code, Section 1001.

Check here if comments are provided on back of form.  Were latitude and longitude in Section A provided by a licensed land surveyor?  Yes  No

Certifier's Name Joseph Kavalier		License Number 12345	
Title Surveyor	Company Name Surveyors Inc		
Address 1234 Survey Street	City Richmond	State VA	ZIP Code 54321
Signature	Date	Telephone	

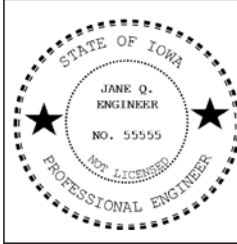

Figure 6-25. Elevation certificate excerpt for the Chester house

CITY OF NORFOLK ASSESSOR				
Pin	12345-67898-76543			
Deed	CHESTER ABRAHAM			
Property Address	1234 BAY STREET NORFOLK, VA 12345			
Class	RESIDENTIAL			
Current Value Information				
Land Value	Dwelling Value	Improvement Value	Total Value	
25,461	102,000	0	127,461	
Prior Year Value Information				
Year	Land Value	Dwelling Value	Improvement Value	Total Value
2011	25,461	102,000	0	127,461
2010	25,461	102,000	0	127,461
2009	27,508	105,333	0	132,841
2008	27,508	105,333	0	132,841
2007	27,508	105,333	0	132,841
Residential Building Information				
Occupancy	Style	Year Built	Total Living Area	
Single-Family/Owner Occupied	1 Story Frame	1983	1,275	
Yard Extra Information				
Description	Item Count	Year Built		
NA				
Land Information				
Lot Basis	Square Feet	Acres		
Lump Sum	5,400	0.124		
Tax History Information				
Tax Year	Assessed Value	Taxable Value	Gross Tax	Net Tax
2009	127,461	58,108	9,404	9,400
2008	132,841	53,136	8,502	8,540
2007	132,841	60,223	10,022	10,001
2006	132,841	61,132	11,276	11,200

Figure 6-26. Tax card for the Chester house (page 1)

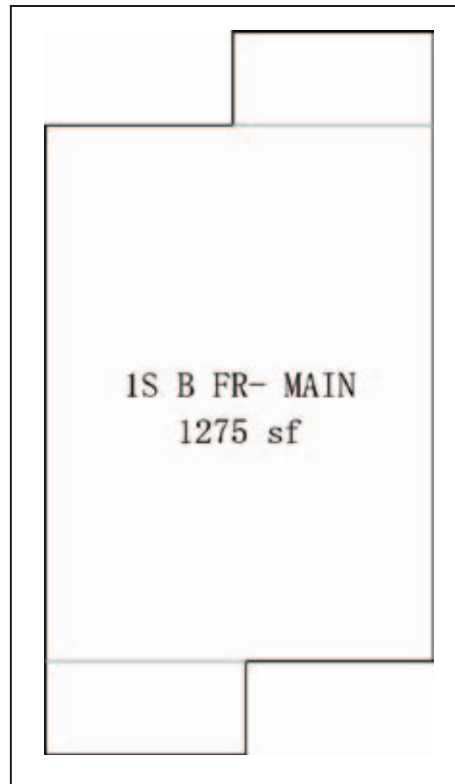

Figure 6-26 (concluded).  
Tax card for the Chester  
house (page 2)

16 Sep 2011	Project: <b>Case Study 2</b>	Pg 1 of 21
Total Benefits: <b>\$497,269</b>	Total Costs: <b>\$292,461</b>	BCR: <span style="border: 1px solid black; padding: 2px;">1.70</span>
Project Number:	Disaster #:	Program:
State: <b>Virginia</b>	Point of Contact:	Agency: <b>City of Norfolk</b>
		Analyst:

**Project Summary:**

Project Number: \_\_\_\_\_ Disaster #: \_\_\_\_\_  
 Program: \_\_\_\_\_ Agency: City of Norfolk  
 Analyst: \_\_\_\_\_  
 Point of Contact: \_\_\_\_\_ Phone Number: \_\_\_\_\_  
 Address: Virginia  
 Email: \_\_\_\_\_  
 Comments: \_\_\_\_\_

**Structure Summary For:**

1-Elevation, 1234 Bay Street, Norfolk, Virginia, 12345, Norfolk City

Structure Type: Building      Historic Building: No      Contact: \_\_\_\_\_  
 Benefits: \$227,014      Costs: \$150,000      BCR: 1.51

Mitigation	Hazard	BCR	Benefits	Costs
Elevation	Flood	1.51	\$227,014	\$150,000

2-Acquisition, 1234 Bay Street, Norfolk, Virginia, 12345, Norfolk City

Structure Type: Building      Historic Building: No      Contact: \_\_\_\_\_  
 Benefits: \$270,255      Costs: \$142,461      BCR: 1.90

Mitigation	Hazard	BCR	Benefits	Costs
Acquisition	Flood	1.90	\$270,255	\$142,461

Figure 6-27. Sample BCA Report excerpt for the Chester house elevation and acquisition



## 6.2.6 Real World Examples

Although the Chester house is fictional, elevation and acquisition are both commonly used flood mitigation measures. Figures 6-28 and 6-29 are examples of real structures that have been protected using the mitigation measures discussed in this case study.

These homes were elevated on timber piles.



Figure 6-28.  
House elevated on timber piles



Figure 6-29.  
Elevation on timber piles



## 6.3 Case Study #3: Residential Retrofit Outside of the Floodplain Using Dry or Wet Floodproofing

This case study exercise examines the retrofit of a residential building outside the floodplain by means of dry floodproofing or wet floodproofing. Details are provided in the subsections that follow.

### 6.3.1 Description of Property

Jorge Luis Borges  
18 Chai Avenue  
Memphis, TN 36549

The Borges family built their home in 1992. It is a one-story structure with a walkout-on-grade basement that serves as a garage. It is not in the floodplain but, due to the sloping terrain and the development in the area, water tends to collect in their backyard. Since living in the house, they've had water in their garage nearly every time it rains. On four occasions, they have had to conduct some repairs and replacements to damaged items and building materials. Mr. Borges estimated the amount of damage he incurred during each event (see Table 6-6). The main level does not have any flooding problems.

The Borges family does not live in the SFHA and, therefore, does not have flood insurance. However, the damage they incurred in 2011 encouraged them to retrofit their home to protect it against further damages.

### 6.3.2 Structure Information

18 Chai Avenue is a good quality, 1-story masonry house with a walkout-on-grade garage (see Figures 6-30 and 6-31).

Figure 6-30.  
Plan drawing for the  
Borges house

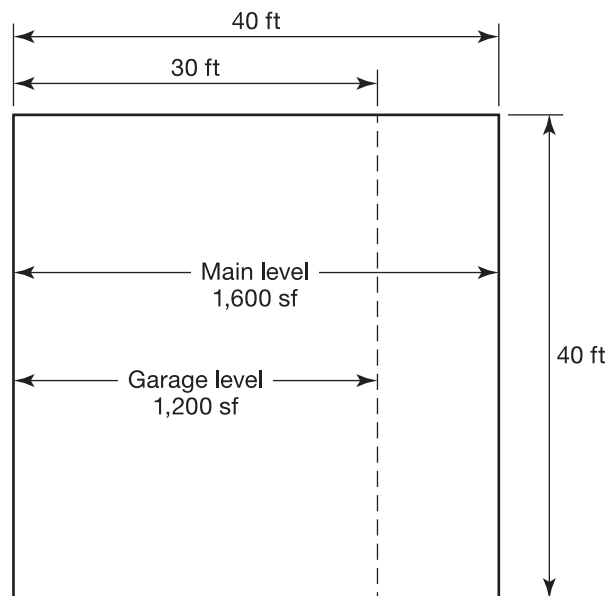

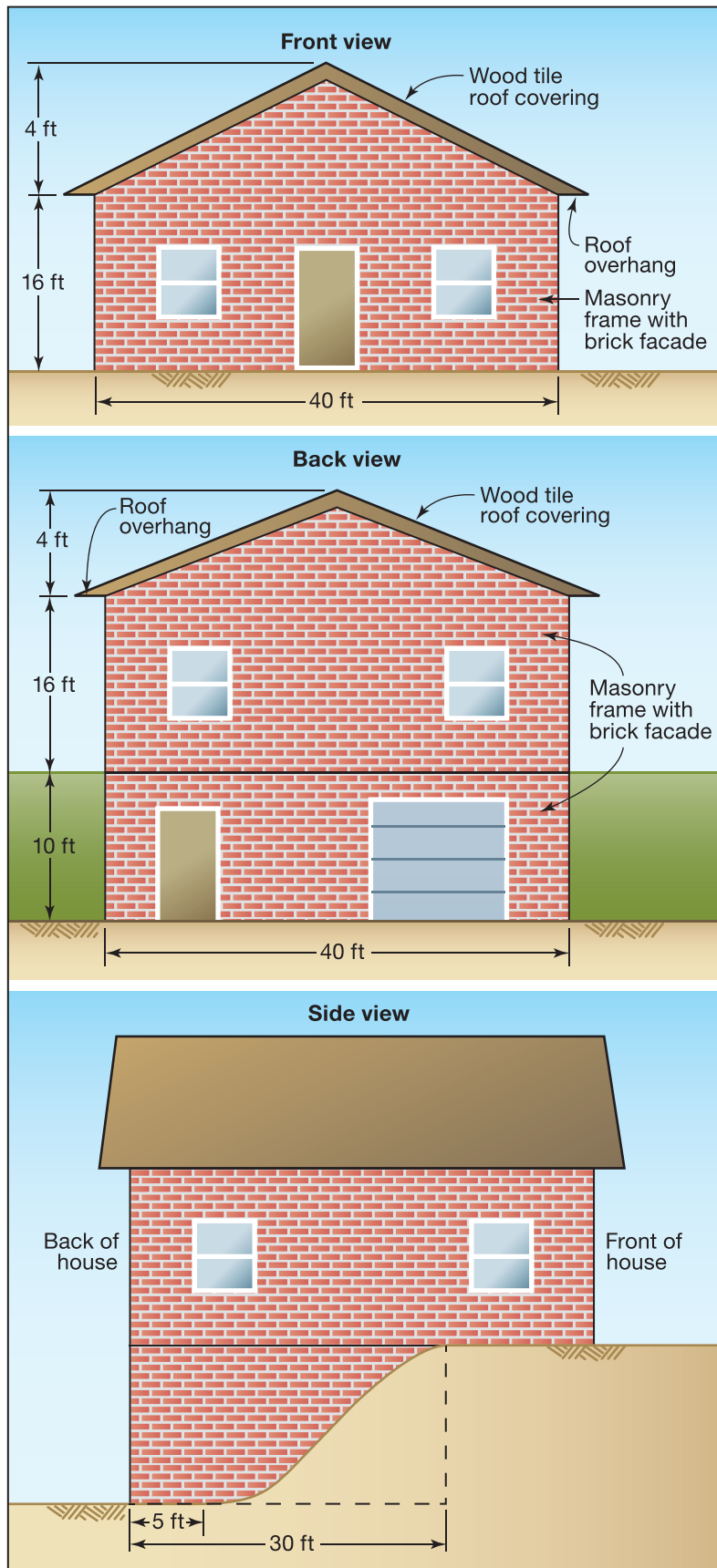

Figure 6-31. Elevation drawings from the front, back, and side of the Borges house

Other structure information includes:

- Main floor (footprint): 1,600 square feet (40 feet x 40 feet)
- Garage: 1,200 square feet (30 feet x 40 feet)
- Foundation:
  - Garage walls are reinforced and grouted CMU block, 8 inches thick, supported by a 2-foot-wide x 1-foot-thick concrete wall footer with a 6-inch-thick interior concrete slab.
  - Main floor over garage is supported on 2-inch x 8-inch joists spaced at 16 inches on center. Main floor not over garage is 4-inch-thick concrete slab supported by a 2-foot-wide x 1-foot-thick concrete wall footer.
  - Approximately 5 feet of the side garage walls are exposed at grade level.
  - Below-grade walls have an existing drainage system to control hydrostatic pressures below ground.
- Structure:
  - Main structure: Concrete block with common brick veneer
  - Garage: Concrete block with common brick veneer
  - Wood-frame interior walls with gypsum board sheathing
- Roof:
  - Gable roof with 1-foot overhangs over main structure
  - Asphalt shingle roof covering over entire roof
- Interior:
  - Wood stud interior walls with gypsum board sheathing
  - Hardwood floor coverings
- Entrances:
  - The garage has two entrances: a single pedestrian door (3-feet wide) and a standard garage door (8-feet wide)
  - There are no other windows or entrances in the garage

### Plot

No part of the Borges' plot is in the floodplain. The site soils are primarily poorly graded gravel (Soil Type GP).

### Building Assessment

An updated tax card is included at the end of this case study as an alternate source of the building replacement value as well as to verify the building square footage data.

Additionally, an engineer's estimate is that the Borges' home has a building replacement value of approximately \$100.00 per square foot, based on popular cost estimating guides.

### Flood Hazard Data

Because 18 Chai Avenue is not in the floodplain, there is no BFE for the structure. However, Mr. Borges has kept records of flood events that required some repairs. Flood depths are in inches from the top of the garage floor (see Table 6-6).

**Table 6-6. Summary of Damages for the Borges House**

Damage Year	Flood Depth (inches)	Damages (2011 dollars)
1994	6	\$2,500
1999	1	\$500
2003	2	\$800
2011	8	\$5,000

Based on this history of flooding, Mr. Borges would like to protect his house from up to 2 feet of flooding.

### 6.3.3 Retrofit Options Selection

During an initial interview with the Borges family, potential retrofit options were discussed (Figure 6-32). Initially, relocation was quickly ruled out because the Borges family was not willing to move. Floodwalls and levees were also ruled out, because there is not sufficient space on the property to undertake those methods. Although elevation was considered, it is not required and the costs were unreasonably high for the required level of protection.









Based on the retrofit option screening matrix, the two most viable options are dry floodproofing and wet floodproofing.

#### Dry Floodproofing

The purpose of dry floodproofing is to keep the water out of the garage. Refer to Table 1-3 for the advantages and disadvantages of dry floodproofing. This would involve:

- applying a waterproof sealant to the exterior of the CMU block walls, approximately \$12/linear foot for a 2-foot flood depth (note that the sealant need only be applied to exposed walls because there is an existing drainage system for below-grade walls); and
- installing metal flood shields over the two doors, approximately \$250/linear foot for a 2-foot flood depth.

Note that other dry floodproofing measures such as check valves, sump pumps, and drainage are not considered because there is no plumbing in the garage.

Preliminary Floodproofing/Retrofitting Preference Matrix									
Owner Name:		Jorge Juis Borges			Prepared By:		Jane Q. Engineer		
Address:		18 Chai Avenue				Date:		9/1/2011	
Property Location:		Memphis, TN							
Floodproofing Measures									
Considerations									
	Elevation on Foundation Walls	Elevation on Fill	Elevation on Piers	Elevation on Posts and Columns	Elevation on Piles	Relocation	Dry Flood-proofing	Wet Flood-proofing	Floodwalls and Levees
Note the measures NOT allowed						X			X
Homeowner Concerns									
Aesthetic Concerns	X	X	X	X	X				
High Cost Concerns	X	X	X	X	X				
Risk Concerns	X	X					X	X	
Accessibility Concerns	X	X	X	X					
Code Required Upgrade Concerns									
Off-Site Flooding Concerns	X	X					X		
Total "X's"	5	5	3	3	3	NA	2	1	NA

Instructions: Determine whether or not floodproofing measure is allowed under local regulations or homeowner requirement. **Put an "x" in the box for each measure which is not allowed.**

Complete the matrix for only those measures that are allowable (no "x" in the first row). For those measures allowable or owner required, evaluate the considerations to determine if the homeowner has concerns that would affect its implementation. A concern is defined as a homeowner issue that, if unresolved, would make the retrofitting method(s) infeasible. If the homeowner has a concern, place an "x" in the box under the appropriate measure/consideration. Total the number of "x's". The floodproofing measure with the least number of "x's" is the most preferred.

Figure 6-32. Preliminary Floodproofing/Retrofitting Preference Matrix for the Borges house

The exposed areas of the CMU wall are:

$$\textit{Back wall: } 40 \text{ ft} - 3 \text{ ft} - 8 \text{ ft} = 29 \text{ ft}$$

$$\textit{Side walls: } 2 \times 5 \text{ ft} = 10 \text{ ft}$$

Therefore, the total cost of sealant is  $(10 \text{ ft} + 29 \text{ ft}) \times \$12/\text{lf} = \$468$

Refer to Figure 5D-3 in Chapter 5D for details of sealant systems.

Metal closures would require  $3 \text{ ft} + 8 \text{ ft} = 11 \text{ ft}$  of closure.

Therefore, the total cost of closures is  $(11 \text{ ft}) \times \$250/\text{lf} = \$2,750$

Refer to Figures 5D-5 and 5D-6 in Chapter 5D for closure details.

The total cost of dry floodproofing is \$3,218. Additionally, an additional \$75 per year will be needed to maintain the floodproofing sealants and shields.

Using this cost estimate, a preliminary BCA yields a BCR of 1.39. Therefore, this project would be cost effective.

This technique may be effective for a few inches of water, but it could lead to far more significant damages for greater levels of flooding. Dry floodproofing may not work for water levels that are sufficient to cause uplift against the underside of the garage slab, leading to cracking and water intrusion into the garage. See Section 6.3.4 for calculations related to the slab of the house. The hydrostatic forces associated with 2 feet or more of water on the slab would likely cause the slab to crack, allowing water into the garage and resulting in severe damage to the foundation of the house. This option is included here to illustrate its use; however, it is strongly recommended that the wet floodproofing option be used over the dry floodproofing option. Refer to the buoyancy check calculations in Section 6.3.4 for further information.

### Wet Floodproofing

The purpose of wet floodproofing would be to allow water into the garage to equalize hydrostatic forces. Refer to Table 1-4 for the advantages and disadvantages of wet floodproofing. This would involve:

- elevating all stored contents above the floodproofing depth (2 feet);
- elevating all utilities above the floodproofing depth (2 feet); and
- installing flood vents along back wall and sides of house (see Figure 5E-15).

Note that wet floodproofing often includes replacing interior finishes with flood damage-resistant materials. Because the wet floodproofed area is a garage, there are no interior finishes. Additionally, concrete block walls and floors are considered to be flood damage-resistant under NFIP Technical Bulletin 2-08, *Flood Damage-Resistant Materials Requirements for Buildings Located in Special Flood Hazard Areas in accordance with the National Flood Insurance Program* (FEMA, 2008a).

It is expected that the cost of wet floodproofing will be approximately \$3,600, with an additional \$50 a year budgeted to maintain the project, including clearing flood vents. A preliminary BCA yields a BCR of 1.41. Therefore, this project would also be cost effective.

### 6.3.4 Load Calculations

The paragraphs that follow provide calculations for flood loads, dead loads, live loads, and load combinations, as well as bearing capacity, sliding, uplift, and overturning checks associated with the dry and wet floodproofing options.

#### Load Calculations: Flood Loads

The first step is to calculate hydrostatic forces (Figure 6-33). As determined above, the floodproofing depth  $H$  is 2 feet. The house is slab-on-grade, so the saturated soil depth is 0 feet (again, these calculations are for the exposed walls only; there is an existing drainage system for the buried walls). Note that, for dry floodproofing, the hydrostatic forces act on the house in both the horizontal and vertical directions. For wet floodproofing, however, the hydrostatic forces are equalized, so the equivalent hydrostatic force (vertical and horizontal) is 0 pounds.

Because the source of flooding is surface runoff rather than a water body, the flow velocity is considered to be 0 ft/sec and there are no hydrodynamic or flood-borne debris impact forces.

Flood Force Summary:

*Horizontal Force:*

$$f_{comb} = 124.8 \text{ lb/lf}$$
$$F_i = 0 \text{ lbs}$$

The total flood force acting on the back wall is:

$$F_{sta} = (124.8 \text{ lb/lf} \times 40 \text{ ft}) = 4,992 \text{ lbs (dry floodproofing)}$$

*Vertical Force:*

$$F_{buoy} = 149,760 \text{ lbs (dry floodproofing)}$$

#### Load Calculations: Dead Loads

The dead load is the self-weight of the structure. Case Study #1 illustrates a detailed calculation of the dead load. For this case study, assume a dead weight of approximately 40 lb/ft<sup>2</sup> over 1,600 square feet for the main level, plus approximately 40 lb/ft<sup>2</sup> over 1,200 ft<sup>2</sup> for the garage.

$$D = 40 \text{ lb/ft}^2 \times (1,600 \text{ ft}^2) + 40 \text{ lb/ft}^2 \times (1,200 \text{ ft}^2) = 112,000 \text{ lbs}$$

#### Load Calculations: Live Loads

*Live Load (Vertical)*

Per ASCE 7-10, assume a live load of:

$$L = 40 \text{ lb/ft}^2 \times (1,600 \text{ ft}^2 + 1,200 \text{ ft}^2) = 112,000 \text{ lbs}$$



Hydrostatic Force Computation Worksheet	
Owner Name: _____	Jorge Juis Borges
Prepared By: _____	Jane Q. Engineer
Address: _____	18 Chai Avenue
Date: _____	9/1/2011
Property Location: _____	Memphis, TN
<b>Constants</b>	<b>Summary of Loads</b>
$\gamma_w$ = specific weight of water = 62.4 lb/ft <sup>3</sup> for fresh water and 64.0 lb/ft <sup>3</sup> for saltwater	$f_{sta}$ = 124.8 lb/ft
<b>Variables</b>	$f_{dif}$ = 0 lb/ft
$H$ = floodproofing design depth (ft) = 2 ft	$f_{comb}$ = 124.8 lb/ft
$D$ = depth of saturated soil (ft) = 0 ft	$F_{buoy}$ = 149,760 lbs
$S$ = equivalent fluid weight of saturated soil (lb/ft <sup>3</sup> ) = 75 lb/ft <sup>3</sup>	
$Vol$ = volume of floodwater displaced by a submerged object (ft <sup>3</sup> ) = 1,200 ft <sup>2</sup> x 2 ft = 2,400 ft <sup>3</sup>	
$P_b$ = hydrostatic pressure due to standing water at a depth of $H$ (lb/ft <sup>2</sup> ), $P_b = \gamma_w H = 124.8$ lb/ft <sup>2</sup>	
<b>Equation 4-4: Lateral Hydrostatic Force</b>	
$f_{sta} = \frac{1}{2} P_b H = \frac{1}{2} \gamma_w H^2 = (1/2)(62.4 \text{ lb/ft}^3)(2 \text{ ft})^2 = 124.8 \text{ lb/ft}$	
<b>Equation 4-5: Submerged Soil and Water Force</b>	
$f_{dif} = \frac{1}{2} (S - \gamma_w) D^2 = 0 \text{ lb/ft}$	
<b>Equation 4-6: Combined Lateral Hydrostatic Force</b>	
$F_{buoy} = \gamma_w (Vol) = 124.8 \text{ lb/ft} + 0 \text{ lb/ft} = 124.8 \text{ lb/ft}$	
<b>Equation 4-7: Buoyancy Force</b>	
$dh = \frac{C_d V^2}{2g} = (62.4 \text{ lb/ft}^3)(2,400 \text{ ft}^3) = 149,760 \text{ lbs}$	

Figure 6-33. Hydrostatic Force Computation Worksheet for the Borges house (Refer to Figure 4-9)

#### Roof Live Load (Vertical)

Per ASCE 7-10, assume a roof live load of 20 lb/ft<sup>2</sup>. The roof live load acts on the horizontal projected area of the roof:

$$L_r = 20 \text{ lb/ft}^2 \times (1,600 \text{ ft}^2) = 32,000 \text{ lbs}$$

#### Snow Load (Vertical)

Assume a conservative snow load of 20 lb/ft<sup>2</sup>, per ASCE 7-10. The snow load also acts on the horizontal projected area of the roof.

$$S = 20 \text{ lb/ft}^2 \times (1,600 \text{ ft}^2) = 32,000 \text{ lbs}$$

*Wind Load (Horizontal)*

Appendix C contains a detailed discussion of wind load calculations, including a detailed example. Refer to Appendix C for wind load calculations; this case study uses a simplified approach. Using a simplified wind load, assuming that the structure is fully enclosed, assume a worst case scenario wind load acting perpendicular to the structure (i.e., on the entire face of the structure facing the river). Therefore, assume a wind pressure of 30 lb/ft<sup>2</sup> acting uniformly over the entire aboveground structure:

$$\begin{aligned} \text{Area} &= \text{Exterior Wall area} + \text{Vertical Roof area} \\ \Rightarrow A &= (40 \text{ ft})(10 \text{ ft}) + (40 \text{ ft})(16 \text{ ft}) + (1/2)(4 \text{ ft})(40 \text{ ft}) = 1,120 \text{ ft}^2 \\ W_H &= 30 \text{ lb/ft}^2 \times (1,120 \text{ ft}^2) = 33,600 \text{ lbs} \end{aligned}$$

*Wind Load (Vertical)*

With a 1-foot overhang, assume that the only vertical wind force is acting upwards on the horizontal projected area of the overhangs (a simplification).

The horizontal projected area is taken to be 1 foot as a conservative estimate.

The upward wind force acts on the length of the overhang (40 feet) on each side of the house. Therefore, the total horizontal area is:

$$\Rightarrow A = 2 \times 1 \text{ ft} \times 40 \text{ ft} = 80 \text{ ft}^2$$

Assuming a vertical wind load of 20 lb/ft<sup>2</sup>, the total vertical wind load is:

$$W_V = 20 \text{ lb/ft}^2 \times (80 \text{ ft}^2) = 1,600 \text{ lbs}$$

*Earthquake Load*

Earthquake forces are assumed to be negligible for this location, because the project is located far from the New Madrid fault. Therefore, for the purposes of this case study,  $E = 0$ .

**Load Combinations**

To determine the worst-case horizontal and vertical loading scenarios, ASCE 7-10 load combinations are used (Allowable Stress Design).

Load Summary:

*Horizontal Loads*

$$\begin{aligned} D &= L = L_r = S = E = 0 \\ F_a &= F_{sta} = 4,992 \text{ lbs (dry floodproofing)}; F_a = 0 \text{ lbs (wet floodproofing)} \\ W &= 33,600 \text{ lbs} \end{aligned}$$

*Vertical Loads*

$$\begin{aligned} D &= 112,000 \text{ lbs (}\downarrow\text{)} \\ L &= 112,000 \text{ lbs (}\downarrow\text{)} \\ L_r &= 32,000 \text{ lbs (}\downarrow\text{)} \\ S &= 32,000 \text{ lbs (}\downarrow\text{)} \\ W &= 1,600 \text{ lbs (}\uparrow\text{)} \\ E &= 0 \\ F_a &= F_{buoy} = 149,760 \text{ lbs (}\uparrow\text{) (dry floodproofing), } F_a = 0 \text{ (wet floodproofing)} \end{aligned}$$

Table 6-7 presents a summary of the horizontal and vertical loads for the Borges house.

**Table 6-7. Summary of Horizontal and Vertical Load Combinations for the Borges House Combination**

	Horizontal (lbs)	Vertical (lbs)
1. $D$	0	112,000
2. $D + L$	0	224,000
3. $D + (L_r \text{ or } S \text{ or } R)$	0	144,000
4. $D + 0.75L + 0.75(L_r \text{ or } S \text{ or } R)$	0	220,000
5. $D + (0.6W \text{ or } 0.7E) + 0.75F_a$	23,904 (dry)	-1,280 (dry)
	20,160 (wet)	111,040 (wet)
6a. $D + 0.75L + 0.75(0.6W) + 0.75(L_r \text{ or } S \text{ or } R) + 0.75F_a$	18,864 (dry)	106,960 (dry)
	15,120 (wet)	219,280 (wet)
6b. $D + 0.75L + 0.75(0.7E) + 0.75S + 0.75F_a$	3,744 (dry)	107,680 (dry)
	0 (wet)	220,000 (wet)
7. $0.6D + 0.6W + 0.75F_a$	23,904 (dry)	-46,080 (dry)
	20,160 (wet)	66,240 (wet)
8. $0.6D + 0.7E$	0	67,200

### Bearing Capacity Check

$$P_{max} = A_{bearing} S_{bc}$$

$$S_{bc} = 2,500 \text{ lb/ft}^2 \text{ (see Table 5-2)}$$

The bearing area is taken to be the area of the footer under the garage:

$$A_{bearing} = 2 \text{ ft} \times (2 \times 40 \text{ ft} + 2 \times 30 \text{ ft}) - (4 \text{ ft} \times 2 \text{ ft}) = 272 \text{ ft}^2$$

$$P_{max} = (2,500 \text{ lb/ft}^2)(272 \text{ ft}^2) = 680,000 \text{ lbs}$$

Maximum vertical load:

$$436,000 \text{ lbs} < P_{max} \checkmark$$

### Sliding

Lateral forces are resisted by the walls of the structure, buried footers, and the slab. An analysis of resistance to sliding on foundation walls is included in Case Study 1. Additional sliding resistance will be provided by the slab.

Note that, although the home is unlikely to slide, the garage walls are susceptible to cracking due to lateral hydrostatic forces.

### Uplift and Overturning

Resistance to uplift and overturning will be provided by the footers, the slab, and the soil below grade. An analysis of uplift resistance provided by footers is included in Case Study 1, and that additional resistance is provided by the slab. Note that, although the structure is unlikely to float out of the ground, the slab is susceptible to cracking (see below).

### Slab Check

For dry floodproofing, it is necessary to check that the slab can resist the vertical and horizontal flood forces. This is done by checking the uplift forces against the dead load of the slab, as well as by checking the bending moment at the slab-to-wall connection. This analysis is a simplified comparison of vertical forces to the dead weight of the slab and does not account for steel reinforcement inside the slab. A slab that is both bottom- and top-reinforced may be able to resist uplift forces without cracking.

For this check, the dead load is the weight of the slab only (not including the rest of the structure):

$$D = 1,200 \text{ ft}^2 \times 6 \text{ in.} \times 1 \text{ ft}/12 \text{ in.} \times 150 \text{ lb}/\text{ft}^3 = 90,000 \text{ lbs}$$

The vertical and horizontal flood forces are the same:

$$F_V = 149,760 \text{ lbs}$$

$$F_H = 4,992 \text{ lbs}$$

The worst case loading scenario for both the uplift and moment checks will be  $0.6D + 0.75F_a$ .

*Uplift:*

$$0.6D = 0.6(90,000 \text{ lbs}) = 54,000 \text{ lbs}$$

$$0.75F_V = 0.75(149,760 \text{ lbs}) = 112,320 \text{ lbs} > 54,000 \text{ lbs} \quad \textbf{NOT ACCEPTABLE (dry floodproofing)}$$

The buoyancy forces are greater than the resisting force of the slab, causing the slab to crack or even rise out of the ground.

*Bending:*

For this check, the pivot point is the connection of the slab to the back wall and only the flood and slab weight forces are included, as shown in Figure 6-34.

$$0.6M_D = 0.6(15 \text{ ft})(90,000 \text{ lbs}) = 810,000 \text{ ft-lbs}$$

$$0.75M_{F_a} = 0.75(15 \text{ ft})(149,760 \text{ lbs}) + 0.75(2/3 \text{ ft})(4,992 \text{ lbs}) = 1,687,296 \text{ ft-lbs} > 810,000 \text{ ft-lbs}$$

**NOT ACCEPTABLE (dry floodproofing)**

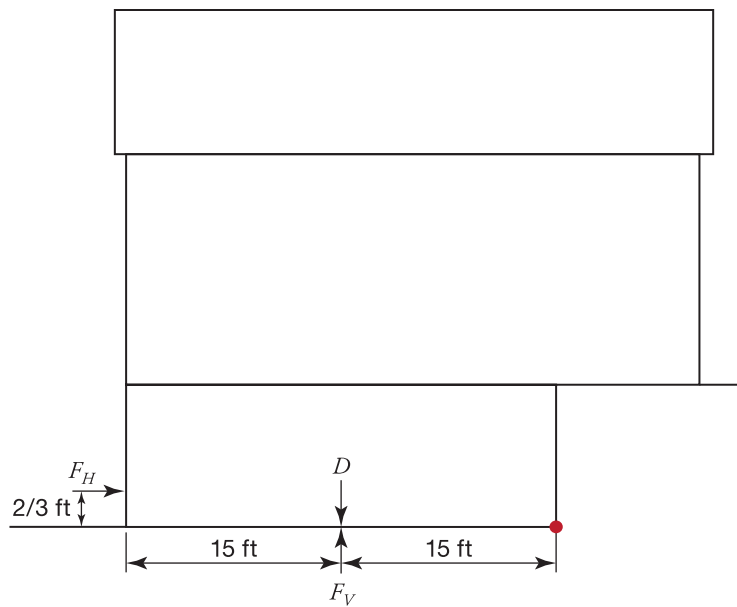

Figure 6-34.  
Moment diagram for the  
Borges house, slab only

The moment resulting from the flood forces is significantly greater than the resistive force of the slab, causing the slab to crack.

Dry floodproofing the existing garage is therefore not an option, because a flood depth of 2 feet would cause the slab to fail, allowing water into the house and requiring expensive repairs. The Borges family can either opt to use wet floodproofing, or they can install a thicker, better reinforced slab.

### 6.3.5 Supporting Documentation

This section includes additional information about the Borges house. The following maps and documents provide backup documentation for the values used in the Case Study 3 calculations, including:

- topographic map showing the location of the plot and ground elevation (Figure 6-35);
- FIRM excerpt showing the location of the Borges house, outside of the 100-year floodplain (Figure 6-36);
- elevation certificate showing the first floor elevation (Figure 6-37);
- tax card providing building value and square footage (Figure 6-38); and
- BCA report excerpt summarizing the cost effectiveness of dry and wet floodproofing (Figure 6-39).

Figure 6-35.  
Topographic map  
showing the location of  
the Borges house (circled  
in red). Please note these  
are 10-foot contours.

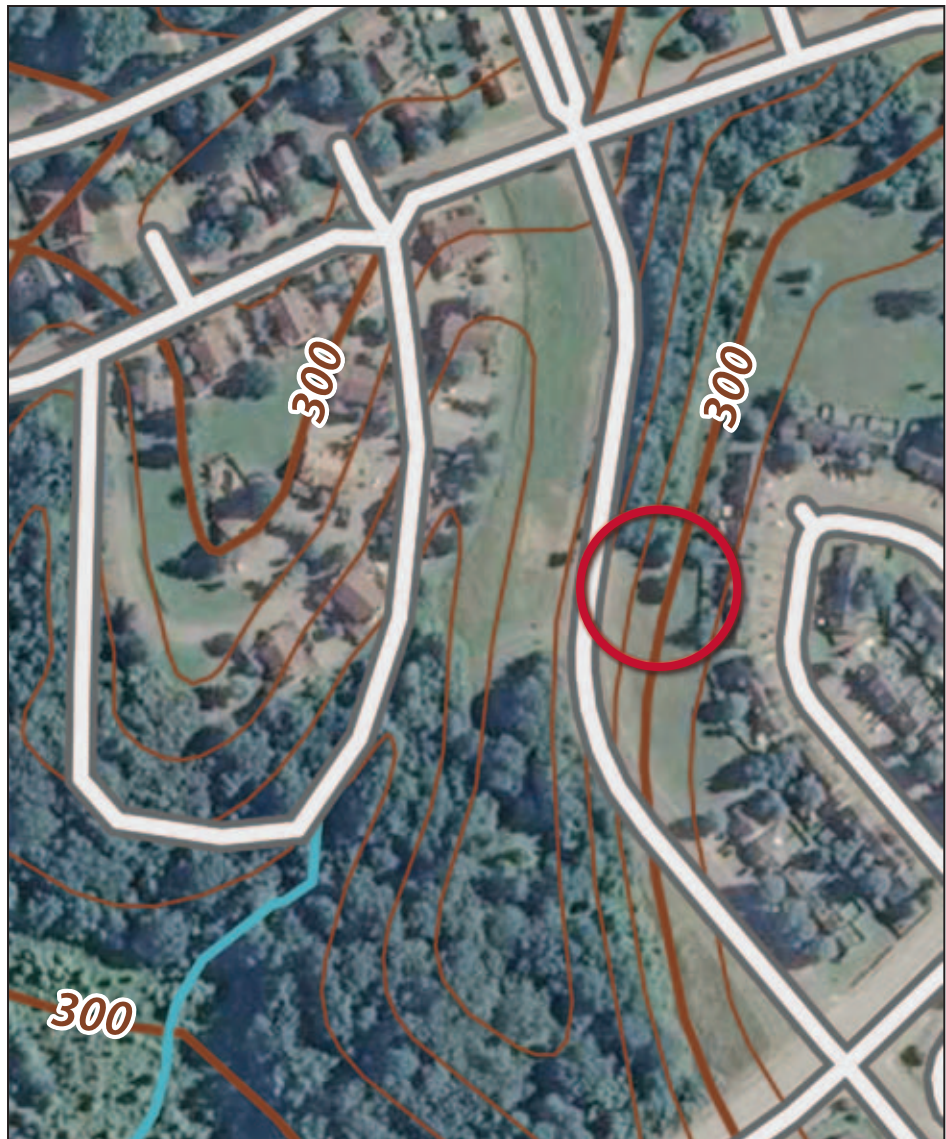



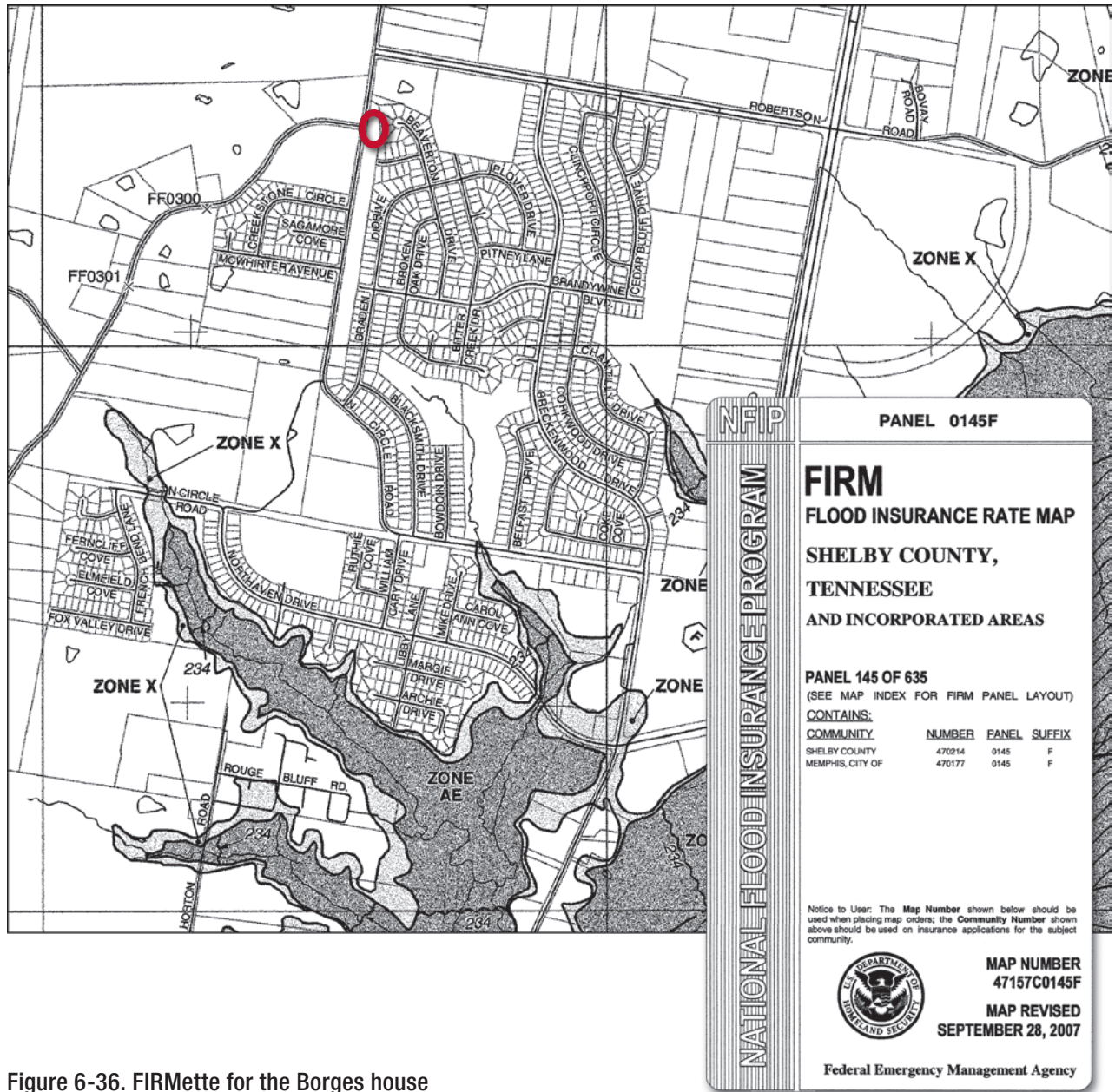

Figure 6-36. FIRMette for the Borges house



U.S. DEPARTMENT OF HOMELAND SECURITY  
Federal Emergency Management Agency  
National Flood Insurance Program

## ELEVATION CERTIFICATE

Important: Read the instructions on pages 1-9.

OMB No. 1660-0008  
Expires March 31, 2012

---

**SECTION A - PROPERTY INFORMATION**

A1. Building Owner's Name Jorge Luis Borges

A2. Building Street Address (including Apt., Unit, Suite, and/or Bldg. No.) or P.O. Route and Box No.  
18 Chai Avenue  
City Memphis State TN ZIP Code 36549

A3. Property Description (Lot and Block Numbers, Tax Parcel Number, Legal Description, etc.)

A4. Building Use (e.g., Residential, Non-Residential, Addition, Accessory, etc.) Residential

A5. Latitude/Longitude: Lat. \_\_\_\_\_ Long. \_\_\_\_\_ Horizontal Datum:  NAD 1927  NAD 1983

A6. Attach at least 2 photographs of the building if the Certificate is being used to obtain flood insurance.

A7. Building Diagram Number \_\_\_\_\_

A8. For a building with a crawlspace or enclosure(s):  
a) Square footage of crawlspace or enclosure(s) \_\_\_\_\_ sq ft  
b) No. of permanent flood openings in the crawlspace or enclosure(s) within 1.0 foot above adjacent grade \_\_\_\_\_  
c) Total net area of flood openings in A8.b \_\_\_\_\_ sq in  
d) Engineered flood openings?  Yes  No

A9. For a building with an attached garage:  
a) Square footage of attached garage 1200 sq ft  
b) No. of permanent flood openings in the attached garage within 1.0 foot above adjacent grade 0  
c) Total net area of flood openings in A9.b 0 sq in  
d) Engineered flood openings?  Yes  No

For Insurance Company Use:

Policy Number \_\_\_\_\_

Company NAIC Number \_\_\_\_\_

---

**SECTION B - FLOOD INSURANCE RATE MAP (FIRM) INFORMATION**

B1. NFIP Community Name & Community Number <u>Memphis, 47147</u>		B2. County Name <u>Shelby</u>		B3. State <u>TN</u>	
B4. Map/Panel Number <u>0145</u>	B5. Suffix <u>F</u>	B6. FIRM Index Date <u>9/28/2007</u>	B7. FIRM Panel Effective/Revised Date	B8. Flood Zone(s) <u>NA</u>	B9. Base Flood Elevation(s) (Zone AO, use base flood depth) <u>NA</u>

B10. Indicate the source of the Base Flood Elevation (BFE) data or base flood depth entered in Item B9.  
 FIS Profile  FIRM  Community Determined  Other (Describe) NA

B11. Indicate elevation datum used for BFE in Item B9:  NGVD 1929  NAVD 1988  Other (Describe) \_\_\_\_\_

B12. Is the building located in a Coastal Barrier Resources System (CBRS) area or Otherwise Protected Area (OPA)?  Yes  No  
Designation Date \_\_\_\_\_  CBRS  OPA

---

**SECTION C - BUILDING ELEVATION INFORMATION (SURVEY REQUIRED)**

C1. Building elevations are based on:  Construction Drawings\*  Building Under Construction\*  Finished Construction  
\*A new Elevation Certificate will be required when construction of the building is complete.

C2. Elevations – Zones A1-A30, AE, AH, A (with BFE), VE, V1-V30, V (with BFE), AR, AR/A, AR/AE, AR/A1-A30, AR/AH, AR/AO. Complete Items C2.a-h below according to the building diagram specified in Item A7. Use the same datum as the BFE.  
Benchmark Utilized \_\_\_\_\_ Vertical Datum \_\_\_\_\_  
Conversion/Comments \_\_\_\_\_

Check the measurement used.

a) Top of bottom floor (including basement, crawlspace, or enclosure floor) <u>250.3</u>	☑ feet <input type="checkbox"/> meters (Puerto Rico only)
b) Top of the next higher floor <u>260.3</u>	☑ feet <input type="checkbox"/> meters (Puerto Rico only)
c) Bottom of the lowest horizontal structural member (V Zones only) _____	<input type="checkbox"/> feet <input type="checkbox"/> meters (Puerto Rico only)
d) Attached garage (top of slab) _____	<input type="checkbox"/> feet <input type="checkbox"/> meters (Puerto Rico only)
e) Lowest elevation of machinery or equipment servicing the building (Describe type of equipment and location in Comments) <u>254.2</u>	☑ feet <input type="checkbox"/> meters (Puerto Rico only)
f) Lowest adjacent (finished) grade next to building (LAG) <u>250.0</u>	☑ feet <input type="checkbox"/> meters (Puerto Rico only)
g) Highest adjacent (finished) grade next to building (HAG) <u>260.0</u>	☑ feet <input type="checkbox"/> meters (Puerto Rico only)
h) Lowest adjacent grade at lowest elevation of deck or stairs, including structural support _____	<input type="checkbox"/> feet <input type="checkbox"/> meters (Puerto Rico only)

---

**SECTION D - SURVEYOR, ENGINEER, OR ARCHITECT CERTIFICATION**

This certification is to be signed and sealed by a land surveyor, engineer, or architect authorized by law to certify elevation information. I certify that the information on this Certificate represents my best efforts to interpret the data available. I understand that any false statement may be punishable by fine or imprisonment under 18 U.S. Code, Section 1001.

Check here if comments are provided on back of form.  Were latitude and longitude in Section A provided by a licensed land surveyor?  Yes  No

Certifier's Name <u>Jane Q. Engineer</u>	License Number <u>183654</u>
Title <u>Project Engineer</u>	Company Name <u>Engineering, Inc.</u>
Address <u>72 McSwarley Street</u>	City <u>Memphis</u> State <u>TN</u> ZIP Code <u>36547</u>
Signature _____	Date _____ Telephone _____



---

FEMA Form 81-31, Mar 09

See reverse side for continuation.

Replaces all previous editions

Figure 6-37. Elevation certificate excerpt for the Borges house

Property Location and Owner Information	2011 Appraisal and Assessment Information
Parcel ID: D0134 L00000	Class: RESIDENTIAL
Property Address: 18 Chai Avenue	Land Appraisal: \$50,900
Municipal Jurisdiction: UNINCORP	Building Appraisal: \$150,338
Neighborhood Number: 0000000	Total Appraisal: \$201,238
Land Square Footage: 6795	
Acres: 0.1560	Total Assessment: \$50,700
Lot Dimensions: 61.55/66.43X110/85	
Subdivision Name: BRECKENWOOD SEC F	Greenbelt Land: \$0
Subdivision Lot Number: 000	Homesite Land: \$0
Plat Book and Page: 00-00	Homesite Building: \$0
Number of Improvements: 0	Greenbelt Appraisal: \$0
Owner Name: BORGES JORGE LUIS	Greenbelt Assessment: \$0
In Care Of:	
Owner Address: 18 Chai Avenue	
Owner City/State/Zip: Memphis, TN 36549	

Dwelling Construction Information	
	Heat: CENTRAL A/C AND HEAT
Stories: 1.5	Fuel: NA
Exterior Walls: Brick Veneer	Heating System: NA
Land Use: Single Family	
Year Built: 1991	Fireplace Masonry: 0
Total Rooms: 6	Fireplace Pre-Fab: 0
Bedrooms: 3	
Bathrooms: 2	Ground Floor Area: 1600
Half Baths: 0	Total Living Area: 1600
Basement Type: Slab	
	Car Parking: Garage

Figure 6-38. Tax card for the Borges house

16 Sep 2011	Project: <b>Case Study 3</b>	Pg 1 of 9
Total Benefits: <b>\$11,700</b>	Total Costs: <b>\$9,191</b>	BCR: <span style="border: 1px solid black; padding: 2px;">1.27</span>
Project Number:	Disaster #:	Program:
State: <b>Tennessee</b>	Point of Contact:	Agency: <b>City of Memphis</b>
		Analyst:

**Project Summary:**

Project Number: \_\_\_\_\_ Disaster #: \_\_\_\_\_  
 Program: \_\_\_\_\_ Agency: City of Memphis  
 Analyst: \_\_\_\_\_  
 Point of Contact: \_\_\_\_\_ Phone Number: \_\_\_\_\_  
 Address: Memphis, Tennessee  
 Email: \_\_\_\_\_  
 Comments: \_\_\_\_\_

**Structure Summary For:**

1-Dry Floodproofing, 18 Chai Ave, Memphis, Tennessee, 36549, Shelby

Structure Type: Building      Historic Building: No      Contact: \_\_\_\_\_  
 Benefits: \$5,757      Costs: \$4,971      BCR: 1.16

Mitigation	Hazard	BCR	Benefits	Costs
Dry Flood Proofing	Damage-Frequency Assessment	1.16	\$5,757	\$4,971

2-Wet Floodproofing, 18 Chai Ave, Memphis, Tennessee, 36549, Shelby

Structure Type: Building      Historic Building: No      Contact: \_\_\_\_\_  
 Benefits: \$5,943      Costs: \$4,220      BCR: 1.41

Mitigation	Hazard	BCR	Benefits	Costs
Other flood proofing measures	Damage-Frequency Assessment	1.41	\$5,943	\$4,220

**Figure 6-39. Sample BCA report excerpt for dry and wet floodproofing of the Borges house**

### 6.3.6 Real World Examples

Although the Borges house is fictional, wet- and dry-floodproofing are both commonly used flood mitigation measures outside of the 100-year floodplain. Figures 6-40 through 6-43 are examples of real structures that have been protected using the mitigation measures discussed in this case study.

Figures 6-40 and 6-41 show flood shields installed in dry floodproofed buildings.



Figure 6-40.  
Example of a flood shield  
over a door



Figure 6-41.  
Example of a flood shield  
over a door

Figures 6-42 and 6-43 show typical flood openings in exterior walls:

**Figure 6-42.**  
Example of flood vents



**Figure 6-43.**  
Example of flood vents





## 6.4 Case Study #4: Residential Retrofit Outside of the Floodplain Using Floodwalls or Levees

This case study exercise examines the retrofit of a residential building outside the floodplain by means of floodwalls or levees. Details are provided in the subsections that follow.

### 6.4.1 Description of Property

Atticus Finch  
Valley House  
2908 Valley Drive  
Bismarck, ND 87421

Atticus Finch is a collector of historic properties. He recently acquired Valley House, which is a historic brick home in Bismarck, North Dakota. The exact construction date is not known, but the structure is presumed to have been built in the late nineteenth or early twentieth century. The structure has been very well maintained over the years and is not in the floodplain. However, changing hydrology, saturated grounds, and recent flooding have meant that the building has been subject to up to 2 feet of flooding several times in recent years.

Mr. Finch would like to protect the building from flooding. However, the building is on the National Register of Historic Places and, therefore, any alterations to the structure that would affect that designation are not permissible.

### 6.4.2 Structure Information

Valley House is a two-story, brick house on a large plot of land (Figure 6-44). The structure sits on an unreinforced concrete footer. The building footprint is 2,500 square feet. Valley House has a complex roof system—some parts are gable, some are hip, and some are flat (multiple roof renovations have been made over the years).

The interior of the house has hardwood floors and wood-frame and plaster walls.

#### Plot

Valley House sits on a large plot of land. The plot itself is relatively flat, but sits at the bottom of a large valley. The soil type is poorly graded sand with silt (Soil Type SM-SP).

#### Building Assessment

An updated tax card is included at the end of this case study as an alternate source of the building replacement value as well as to verify the building square footage data.

Mr. Finch bought Valley House for \$5.8 million in 2005.

Figure 6-44.  
Valley house

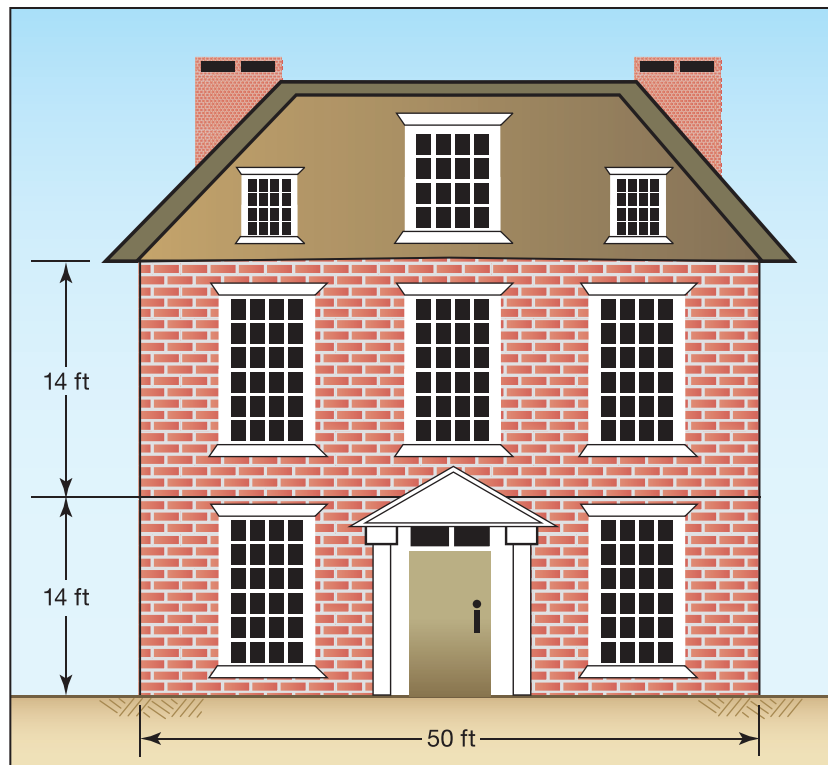

### Flood Hazard Data

Because Valley House sits at the bottom of the valley, there is no single source of flooding, and floodwater can inundate the house from any direction. The maximum rainfall intensity is approximately 1 inch/hour. Since 2005, Mr. Finch has recorded the following damages as shown in Table 6-8.

Mr. Finch would like to protect Valley House from up to 2 feet of flooding plus a 1-foot freeboard.



Table 6-8. Summary of Damages for Valley House

Damage Year	Flood Depth (in.)	Damages (2011 Dollars)
2006	6	\$3,000
2008	12	\$14,000
2009	8	\$8,500
2011	24	\$20,000

### 6.4.3 Retrofit Options Selection

Because Valley House is a historic building, no changes can be made to the structure itself that would affect its designation. Therefore, floodwalls and levees are considered the only viable options (Figure 6-45).



Preliminary Floodproofing/Retrofitting Preference Matrix									
Owner Name: <u>Atticus Finch</u>		Prepared By: <u>Jane Q. Engineer</u>							
Address: <u>2908 Valley Drive</u>		Date: <u>9/1/2011</u>							
Property Location: <u>Bismarck, ND 87421</u>									
Floodproofing Measures									
Considerations									
	Elevation on Foundation Walls	Elevation on Fill	Elevation on Piers	Elevation on Posts and Columns	Elevation on Piles	Relocation	Dry Floodproofing	Wet Floodproofing	Floodwalls and Levees
Note the measures NOT allowed	X	X	X	X	X	X	X	X	
Homeowner Concerns									
Aesthetic Concerns									X
High Cost Concerns									
Risk Concerns									
Accessibility Concerns									X
Code Required Upgrade Concerns									
Off-Site Flooding Concerns									X
Total "x's"	NA	NA	NA	NA	NA	NA	NA	NA	3

Instructions: Determine whether or not floodproofing measure is allowed under local regulations or homeowner requirement. **Put an "x" in the box for each measure which is not allowed.**

Complete the matrix for only those measures that are allowable (no "x" in the first row). For those measures allowable or owner required, evaluate the considerations to determine if the homeowner has concerns that would affect its implementation. A concern is defined as a homeowner issue that, if unresolved, would make the retrofitting method(s) infeasible. If the homeowner has a concern, place an "x" in the box under the appropriate measure/consideration. Total the number of "x's". The floodproofing measure with the least number of "x's" is the most preferred.

Figure 6-45. Preliminary Floodproofing/Retrofitting Preference Matrix for Valley house

## Floodwall

To protect the entire structure, a floodwall should be built around all four sides of the house (Figure 6-46). Refer to Table 1-5 for the advantages and disadvantages of floodwalls. This would involve:

- selecting the site and extent of the floodwall, including distance from the structure;
- excavating for footings;
- installing reinforcing steel and pouring concrete;
- designing and installing drainage system;
- designing and installing access points:
  - one set of stairs for pedestrian access; and
  - one gate with a slide-in closure for vehicle access; and
- backfilling.

Using the simplified design process in Chapter 5F, for Soil Type SM-SP, and to achieve an above-grade floodwall height of 3 feet, the dimensions required for the floodwall can be seen in Figure 6-46.

One way to install an aesthetically pleasing floodwall is to use a brick facing. Figure 5F-8 shows a detail of a brick-faced concrete floodwall.

**Figure 6-46.**  
Floodwall dimensions for  
the Valley house floodwall

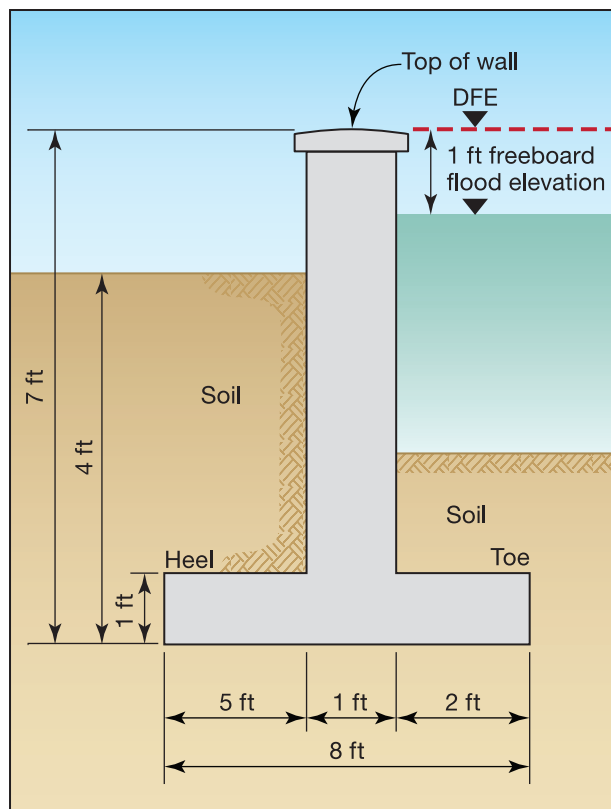

Assuming the centerline of the floodwall should be 50 feet from the house on all sides, a floodwall or levee plan would look as shown in Figure 6-47.

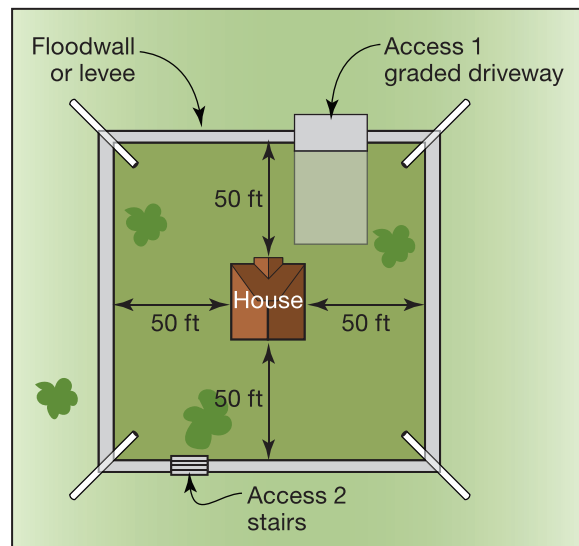

Figure 6-47.  
Plan drawing for Valley  
house floodwall or levee

Refer to the previous case study and Chapter 5D for details on closures.

A preliminary cost estimate suggests that the cost of the floodwall would be approximately \$55,000. Running a BCA on this project does not result in a BCR of greater than 1, because the only recorded damages over the 100 year (or more) life of the structure were recorded in the last few years. However, this project has benefits beyond merely pure economic benefits; it will protect a historic asset. Furthermore, because this project is being conducted outside of the floodplain and thus not being used to bring a structure into compliance with the NFIP, FEMA funding will not be used to complete the project and a BCA is not required.

### Levee

A levee would serve the same purpose as a floodwall, but would require significantly more space to install. Refer to Table 1-5 for the advantages and disadvantages of levees. Installing a levee would involve:

- selecting the site and extent of the levee, including distance from the structure;
- grubbing and clearing levee area;
- excavating for cutoff trench;
- laying and compacting fill;
- designing and installing drainage system;
- designing and installing access points:
  - one set of stairs for pedestrian access; and
  - one graded driveway for vehicle access; and
- seeding.

Using the minimum prescriptive requirements outlined in Chapter 5F, the following dimensions are required for a levee (Figure 6-48).

A ring levee would follow the same plan as the floodwall. However, because the required base width is 27 feet, the levee would take significantly more space to implement.

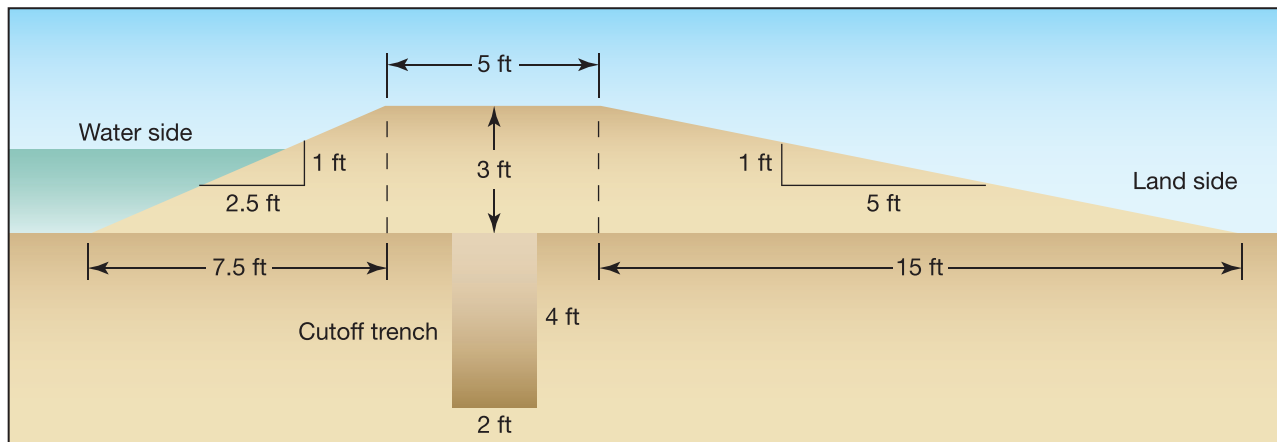

**Figure 6-48. Valley House levee cross-sectional dimensions**

Running a BCA on such a levee (with an assumed cost of approximately \$60,000) yields similar results to the floodwall BCA, and for the same reasons.

### 6.4.4 Load Calculations

Because requirements for floodwalls and levees are prescriptive, load calculations are not required (however, a detailed floodwall analysis can be found in Chapter 5F). Further, because no change is being made to the existing structure itself, it is not necessary to conduct load calculations on the structure to ensure that it can resist sliding, uplift, and overturning.

### 6.4.5 Drainage Requirements

All floodwalls and levees require a drainage system. Figure 6-49 demonstrates drainage requirements for a floodwall or levee.

A review of various national cost guides indicates a pump with a capacity of 161.5 gpm or greater would add an additional \$2,000 to the project cost of the floodwall or levee project.

Interior Drainage Computation Worksheet	
Owner Name: <u>Atticus Finch</u>	Prepared By: <u>Jane Q. Engineer</u>
Address: <u>2908 Valley Drive</u>	Date: <u>9/1/2011</u>
Property Location: <u>Bismarck, ND</u>	
<b>Constants</b>	<b>Summary of Loads</b>
0.01 = factor converting the answer to gpm	$Q_{sp} = 161.5/159.5 \text{ gpm}$
<b>Variables</b>	$Q_a = 157.5 \text{ gpm}$
$A_a$ = is the area enclosed by the floodwall or levee (ft <sup>2</sup> ) = 150 ft x 150 ft = 22,500 ft <sup>2</sup>	$Q_b = 0 \text{ gpm}$
$A_b$ = area discharging to the area partially enclosed by the floodwall or levee (ft <sup>2</sup> ) = 0 ft <sup>2</sup> (fully enclosed levee/floodwall system)	$Q_c = 4/2 \text{ gpm}$
$c$ = residential terrain runoff coefficient of 0.7	
$i_r$ = intensity of rainfall (in./hr) = 1 in./hr	
$s_r$ = seepage rate (gpm) per foot of floodwall/levee = 2 gpm/300 ft (levee); 1 gpm/300 ft (floodwall)	
$l$ = length of the floodwall/levee (ft) = 4 x 150 ft = 600 ft	
<b>Equation 4-14: Runoff Quantity in an Enclosed Area</b>	
$Q_a = 0.01ci_rA_a = 0.01(0.7)(1)(22,500) = 157.5 \text{ gpm}$	
<b>Equation 4-15: Runoff Quantity From Higher Ground into a Partially Enclosed Area</b>	
$Q_b = 0.01ci_rA_b = 0 \text{ gpm}$	
<b>Equation 4-16: Seepage Flow Rate Through a Levee or Floodwall</b>	
<b>Levees</b>	<b>Floodwalls</b>
$Q_c = sr(l) = (2/300)(600) = 4 \text{ gpm}; = (1/300)(600) = 2 \text{ gpm}$	
<b>Equation 4-17: Minimum Discharge for Pump Installation</b>	
$Q_{sp} = Q_a + Q_b + Q_c = \text{length of the floodwall/levee (ft) = 4 x 150 ft = 600 ft}$	

Figure 6-49. Interior Drainage Computation Worksheet for Valley House floodwall or levee

### 6.4.6 Supporting Documentation

This section includes additional information about Valley House. The following maps and documents provide backup documentation for the values used in Case Study 3 calculations, including:

- topographic map showing the location of the plot and ground elevation (Figure 6-50);
- DFIRM excerpt showing the location of Valley House, outside of the 100-year floodplain (Figure 6-51);
- elevation certificate showing the first floor elevation and base flood elevation (Figure 6-52); and
- tax card providing building value and square footage (Figure 6-53).

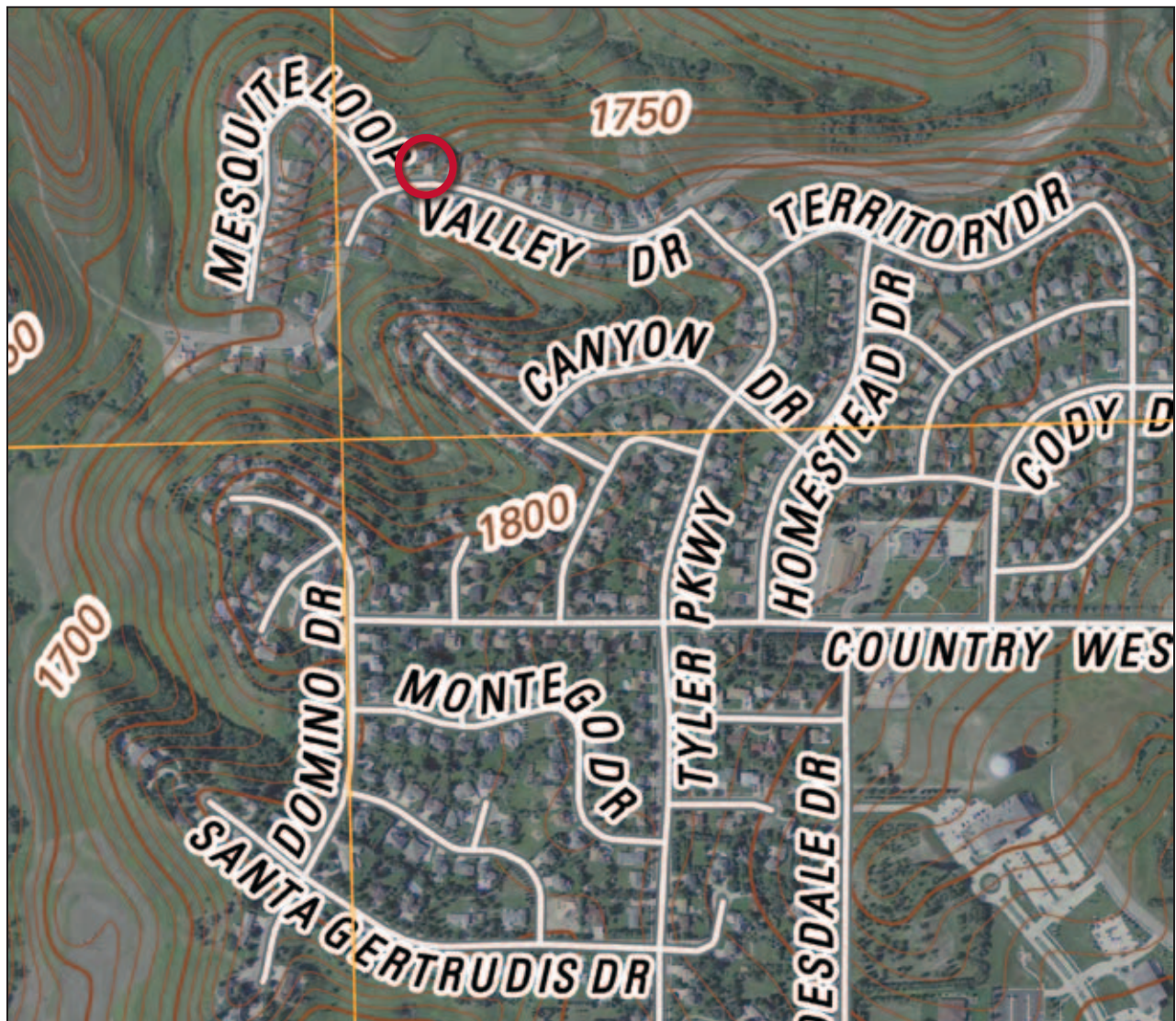

Figure 6-50. Topographic map showing location of Valley house (red circle). Please note these are 10-foot contours.



Levees and floodwalls are generally not cost effective; for that reason, no BCA report is included. However, floodwalls and levees may be the most effective way to protect structures like Valley House.

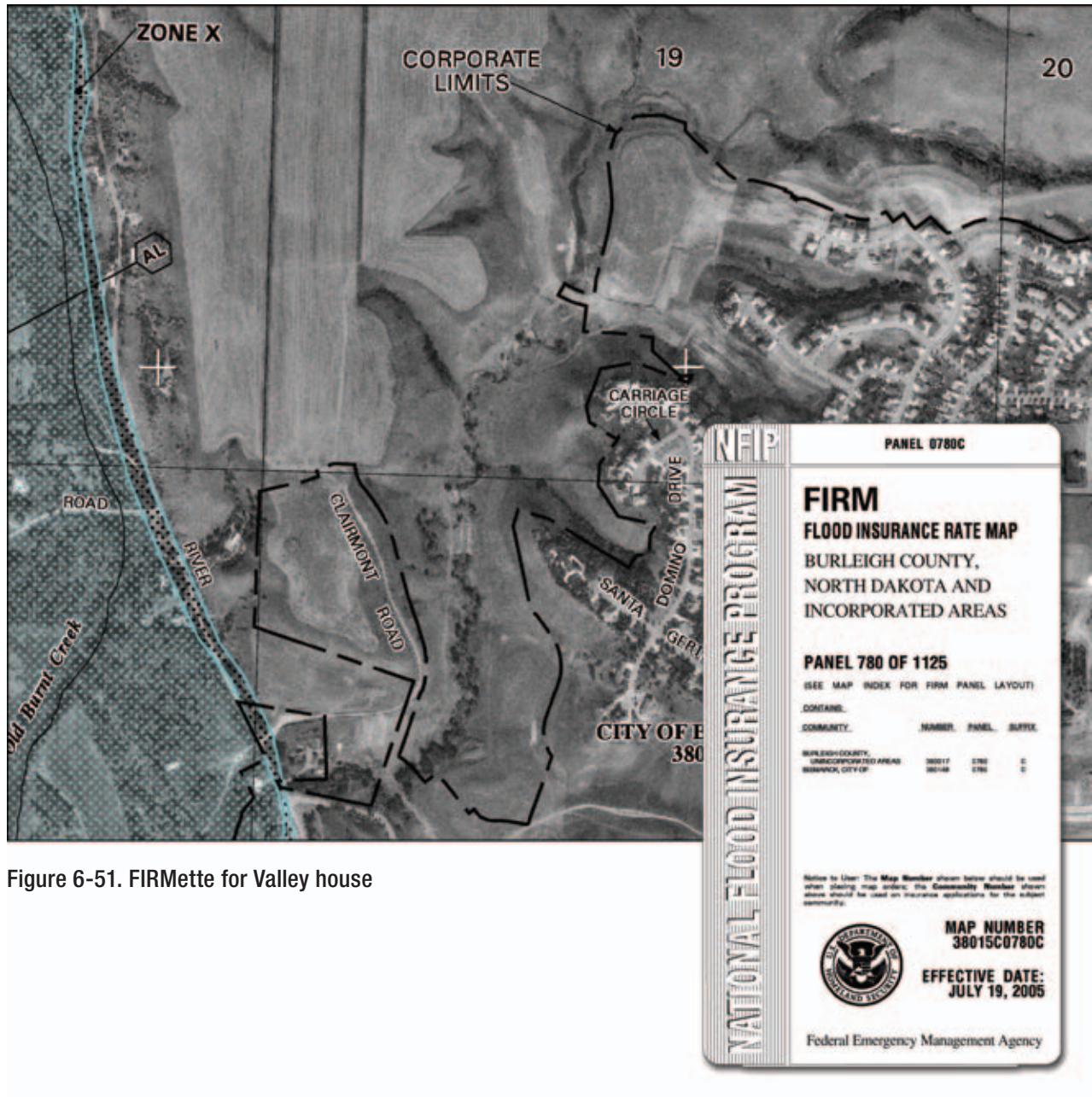

Figure 6-51. FIRMette for Valley house



U.S. DEPARTMENT OF HOMELAND SECURITY  
Federal Emergency Management Agency  
National Flood Insurance Program

## ELEVATION CERTIFICATE

Important: Read the instructions on pages 1-9.

OMB No. 1660-0008  
Expires March 31, 2012

---

**SECTION A - PROPERTY INFORMATION**

A1. Building Owner's Name Atticus Finch

A2. Building Street Address (including Apt., Unit, Suite, and/or Bldg. No.) or P.O. Route and Box No.  
2908 Valley Drive  
City Bismarck State ND ZIP Code 87421

A3. Property Description (Lot and Block Numbers, Tax Parcel Number, Legal Description, etc.)

A4. Building Use (e.g., Residential, Non-Residential, Addition, Accessory, etc.) Residential-Historic

A5. Latitude/Longitude: Lat. \_\_\_\_\_ Long. \_\_\_\_\_ Horizontal Datum:  NAD 1927  NAD 1983

A6. Attach at least 2 photographs of the building if the Certificate is being used to obtain flood insurance.

A7. Building Diagram Number \_\_\_\_\_

A8. For a building with a crawlspace or enclosure(s):  
 a) Square footage of crawlspace or enclosure(s) \_\_\_\_\_ sq ft  
 b) No. of permanent flood openings in the crawlspace or enclosure(s) within 1.0 foot above adjacent grade \_\_\_\_\_  
 c) Total net area of flood openings in A8.b \_\_\_\_\_ sq in  
 d) Engineered flood openings?  Yes  No

A9. For a building with an attached garage:  
 a) Square footage of attached garage \_\_\_\_\_ sq ft  
 b) No. of permanent flood openings in the attached garage within 1.0 foot above adjacent grade 0  
 c) Total net area of flood openings in A9.b 0 sq in  
 d) Engineered flood openings?  Yes  No

For Insurance Company Use:

Policy Number \_\_\_\_\_

Company NAIC Number \_\_\_\_\_

---

**SECTION B - FLOOD INSURANCE RATE MAP (FIRM) INFORMATION**

B1. NFIP Community Name & Community Number Bismarck 380149

B2. County Name Burleigh

B3. State ND

B4. Map/Panel Number 0780	B5. Suffix C	B6. FIRM Index Date 7/15/2005	B7. FIRM Panel Effective/Revised Date	B8. Flood Zone(s) NA	B9. Base Flood Elevation(s) (Zone AO, use base flood depth) NA
------------------------------	-----------------	----------------------------------	---------------------------------------	-------------------------	---

B10. Indicate the source of the Base Flood Elevation (BFE) data or base flood depth entered in Item B9.  
 FIS Profile  FIRM  Community Determined  Other (Describe) NA

B11. Indicate elevation datum used for BFE in Item B9:  NGVD 1929  NAVD 1988  Other (Describe) \_\_\_\_\_

B12. Is the building located in a Coastal Barrier Resources System (CBRS) area or Otherwise Protected Area (OPA)?  Yes  No  
 Designation Date \_\_\_\_\_  CBRS  OPA

---

**SECTION C - BUILDING ELEVATION INFORMATION (SURVEY REQUIRED)**

C1. Building elevations are based on:  Construction Drawings\*  Building Under Construction\*  Finished Construction  
 \*A new Elevation Certificate will be required when construction of the building is complete.

C2. Elevations – Zones A1-A30, AE, AH, A (with BFE), VE, V1-V30, V (with BFE), AR, AR/A, AR/AE, AR/A1-A30, AR/AH, AR/AO. Complete Items C2.a-h below according to the building diagram specified in Item A7. Use the same datum as the BFE.  
 Benchmark Utilized \_\_\_\_\_ Vertical Datum \_\_\_\_\_  
 Conversion/Comments \_\_\_\_\_

Check the measurement used.

a) Top of bottom floor (including basement, crawlspace, or enclosure floor) 1730.3  feet  meters (Puerto Rico only)

b) Top of the next higher floor 1740.3  feet  meters (Puerto Rico only)

c) Bottom of the lowest horizontal structural member (V Zones only) \_\_\_\_\_  feet  meters (Puerto Rico only)

d) Attached garage (top of slab) \_\_\_\_\_  feet  meters (Puerto Rico only)

e) Lowest elevation of machinery or equipment servicing the building (Describe type of equipment and location in Comments) 1730.3  feet  meters (Puerto Rico only)

f) Lowest adjacent (finished) grade next to building (LAG) 1730.0  feet  meters (Puerto Rico only)

g) Highest adjacent (finished) grade next to building (HAG) 1732.1  feet  meters (Puerto Rico only)

h) Lowest adjacent grade at lowest elevation of deck or stairs, including structural support 1730.0  feet  meters (Puerto Rico only)

---

**SECTION D - SURVEYOR, ENGINEER, OR ARCHITECT CERTIFICATION**

This certification is to be signed and sealed by a land surveyor, engineer, or architect authorized by law to certify elevation information. I certify that the information on this Certificate represents my best efforts to interpret the data available. I understand that any false statement may be punishable by fine or imprisonment under 18 U.S. Code, Section 1001.

Check here if comments are provided on back of form.  Were latitude and longitude in Section A provided by a licensed land surveyor?  Yes  No

Certifier's Name Jane Q. Engineer License Number 183654

Title Project Engineer Company Name Engineering, Inc.

Address 72 McSwarley Street City Memphis State TN ZIP Code 36547

Signature \_\_\_\_\_ Date \_\_\_\_\_ Telephone \_\_\_\_\_

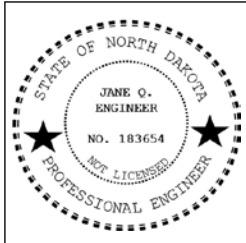

---

FEMA Form 81-31, Mar 09

See reverse side for continuation.

Replaces all previous editions

Figure 6-52. Elevation certificate excerpt for Valley house

Property Location and Owner Information		2011 Appraisal and Assessment Information	
Parcel ID:	D0122 L00000	Class:	RESIDENTIAL-HIST
Property Address:	2908 VALLEY DR	Land Appraisal:	\$143,566
Municipal Jurisdiction:	UNINCORP	Building Appraisal:	\$607,443
Neighborhood Number:	0000000	Total Appraisal:	\$751,009
Land Square Footage:	90,000		
Acres:	2.07	Total Assessment:	\$750,000
Lot Dimensions:			
Subdivision Name:	VALLEY HILLS	Greenbelt Land:	\$0
Subdivision Lot Number:	000	Homesite Land:	\$0
Plat Book and Page:	00-00	Homesite Building:	\$0
Number of Improvements:	0	Greenbelt Appraisal:	\$0
Owner Name:	FINCH ATTICUS	Greenbelt Assessment:	\$0
In Care Of:			
Owner Address:	5674 Main St		
Owner City/State/Zip	Bismarck, ND 87542		
Dwelling Construction Information			
		Heat:	CENTRAL A/C AND HEAT
Stories:	2	Fuel:	NA
Exterior Walls:	BRICK	Heating System:	NA
Land Use:	Historic		
Year Built:	1900 (est)	Fireplace Masonry:	1
Total Rooms:	12	Fireplace Pre-Fab:	0
Bedrooms:	4		
Bathrooms:	3	Ground Floor Area:	2500
Half Baths:	1	Total Living Area:	5000
Basement Type:	Slab		
		Car Parking:	Garage

Figure 6-53. Tax card for Valley House

### 6.4.7 Real World Examples

Although Valley House is fictional, floodwalls and levees are both commonly used flood mitigation measures outside of the 100-year floodplain. The following photos are examples of real structures that have been protected using the mitigation measures discussed in this case study.

Figures 6-54 and 6-55 show residential floodwalls.

Figures 6-56 and 6-57 show residential levees.

**Figure 6-54.**  
Interior sump pump for a residential floodwall



**Figure 6-55.**  
Brick-faced residential floodwall and access stairs





Figure 6-56.  
Residential levee



Figure 6-57.  
Driveway access over a  
residential levee





## APPENDIX A

# Sources of FEMA Funding

Sources of FEMA funding are available to help homeowners implement flood retrofitting projects. Following are details, including eligibility information, about these funding sources.

## A.1 Increased Cost of Compliance Coverage (ICC)

The National Flood Insurance Program (NFIP) includes Increased Cost of Compliance coverage for all new and renewed Standard Flood Insurance Policies. This coverage helps policyholders cover the cost of meeting certain building requirements associated with repairing or rebuilding their home or small business following a flood. An ICC claim may be paid if the home or small business is either:

- **Substantially damaged:** A building is considered substantially damaged by flood if the cost of repairing the flood damage equals or exceeds 50 percent of the building's pre-damage market value.
- **A repetitive loss property:** Under ICC, a building is considered to be a repetitive loss structure when it has had at least two losses over a 10-year period where the cost of repair, on average, equaled or exceeded 25 percent of the building's market value at the time of each flood.

Policyholders in Special Flood Hazard Areas (SFHAs) are eligible to receive up to \$30,000 (as of May 2011) to bring their home or small business into compliance with local floodplain and building code requirements. The ICC coverage can be used for elevation, relocation, or demolition projects for residential and non-residential buildings. The coverage can also be used for floodproofing of non-residential buildings. ICC claims are adjusted separately from the flood damage claim filed under the Standard Flood Insurance Policy.

## A.2 FEMA Hazard Mitigation Assistance Programs

FEMA's Hazard Mitigation Assistance (HMA) Program administers several programs that provide grant funding for hazard mitigation projects that reduce or eliminate long-term risk to people and property from natural hazards and their effects. These programs are authorized under the Robert T. Stafford Disaster Relief and Emergency Assistance Act or the



### NOTE

More detailed information regarding FEMA Hazard Mitigation Assistance Programs can be found at <http://www.fema.gov/government/grant/hma/index.shtm>.

National Flood Insurance Act, and as such all programs are subject to changes in statutory requirements and amounts of authorized assistance. All mitigation projects must be cost effective and technically feasible, and meet Environmental Planning and Historic Preservation requirements in accordance with HMA Program requirements. These programs comply with local, State, or national building codes, standards, and regulations. States, Territories, federally recognized Indian Tribal governments, and communities are eligible and encouraged to take advantage of funding provided by the following HMA Programs in both the pre- and post-disaster timeframes:

- **Hazard Mitigation Grant Program:** The Hazard Mitigation Grant Program (HMGP) provides grants to implement long-term hazard mitigation measures *after* a major disaster declaration in a given State. The purpose of HMGP is to reduce the loss of life and property due to natural disasters and to enable mitigation measures to be implemented during recovery from a disaster.
- **Pre-Disaster Mitigation Program:** The Pre-Disaster Mitigation (PDM) Program provides nationally competitive grants for hazard mitigation planning and implementing mitigation projects *before* a disaster event. Funding these plans and projects reduces overall risks to the population and structures, as well as reliance on funding from actual disaster declarations to rebuild after disasters.
- **Flood Mitigation Assistance Program:** The Flood Mitigation Assistance (FMA) Program provides grants for certain flood mitigation projects to reduce or eliminate flood risk to buildings, manufactured homes, and other structures that are currently NFIP insured.
- **Repetitive Flood Claim Program:** The Repetitive Flood Claim (RFC) Program provides grants for flood mitigation projects to reduce flood damages to individual properties that have had one or more NFIP claims.
- **Severe Repetitive Loss Program:** The Severe Repetitive Loss (SRL) Program provides grants for flood mitigation projects that reduce or eliminate long-term flood risk for residential properties that have experienced severe repetitive NFIP losses. Severe repetitive loss is defined as either:
  - a. at least four NFIP claim payments (including building and contents) over \$5,000 each, and the cumulative amount of such claims payments exceeds \$20,000; or
  - b. at least two separate claims payments (building payments only) have been made with the cumulative amount of the building portion of such claims exceeding the market value of the building.

Table A-1 summarizes eligible residential flood mitigation activities that may be funded by the HMA Programs. Note that dry floodproofing of non-historic residential structures, wet floodproofing, floodwalls, and levees are not eligible projects under HMA.

Figure A-1 shows the process for FEMA grant applications and approvals. It is divided into five stages, starting with mitigation planning and ending with project closeout. The process requires coordination among FEMA, the State, and the local government. This is represented by the three rings in the figure.

Regardless of which funds (e.g., HMGP, PDM, FMA, RFC, or SRL) will be used, the FEMA grants cycle process includes the following five stages.



Table A-1. Eligible Residential Flood Mitigation Activities by Program

Eligible Activities	HMGP	PDM	FMA	RFC	SRL
Property Acquisition and Structure Demolition	■	■	■	■	■
Property Acquisition and Structure Relocation	■	■	■	■	■
Structure Elevation	■	■	■	■	■
Mitigation Reconstruction					■
Dry Floodproofing of Historic Residential Structures	■	■	■	■	■
Dry Floodproofing of Non-Residential Structures	■	■	■	■	
Structural Retrofitting of Existing Buildings	■	■			

SOURCE: HAZARD MITIGATION ASSISTANCE UNIFIED GUIDANCE: HAZARD MITIGATION GRANT PROGRAM, PRE-DISASTER MITIGATION PROGRAM, FLOOD MITIGATION ASSISTANCE PROGRAM, REPETITIVE FLOOD CLAIMS PROGRAM, SEVERE REPETITIVE LOSS PROGRAM (FEMA, 2010)

Note: HMGP and PDM are authorized under the Robert T. Stafford Disaster Relief and Emergency Assistance Act. FMA, PDM, and RFC are authorized under the National Flood Insurance Act.

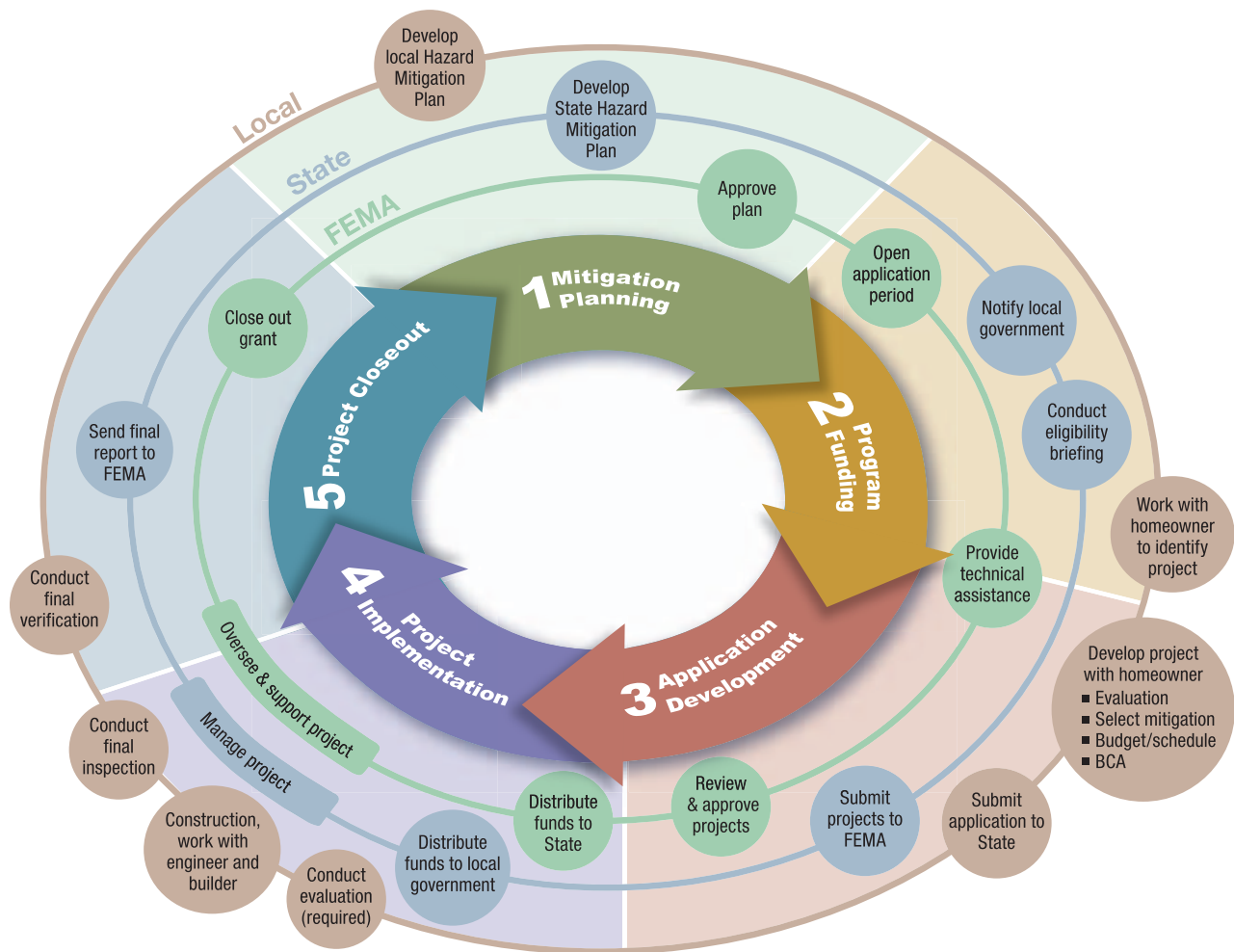

Figure A-1. HMA grants cycle process showing roles and responsibilities of each stakeholder

### A.2.1 Stage 1. Mitigation Planning

A State or Tribal Multi-Hazard Mitigation Plan is a prerequisite for all project grants. The State or Tribal Multi-Hazard Mitigation Plan lays out the process for identifying the hazard risks of a community and the actions that will help reduce those risks. Residential flood mitigation projects that are proposed for FEMA funding under these programs must be consistent with the State’s or Tribe’s mitigation plan. The mitigation planning process requires public participation and identification of measures to reduce risks and is, therefore, a good opportunity for homeowners to address concerns about flood hazards. More information is available on the FEMA website at <http://www.fema.gov/plan/mitplanning>.

### A.2.2 Stage 2. Program Funding

HMA Programs enable hazard mitigation measures to be implemented before, during, and after disasters. Funding depends on the availability of appropriation funding or is based on disaster recovery expenditures, as well as any directive or restriction made with respect to such funds. HMGP funding depends on Federal assistance provided for disaster recovery following a Presidential disaster declaration in a State; PDM and SRL funding may be authorized annually by Congress; and FMA, RFC, and SRL are funded through the National Flood Insurance Fund (NFIF). Once the application period is open, the State notifies the local governments of the availability of funds and relays information on the application process, project requirements, and eligibility criteria for the local government. Table A-2 shows the cost-share requirements for each aforementioned program. Homeowners should work with their local government to express their interest in participating in a residential flood mitigation project; the local government can then submit a subapplication to the State and request HMA funding. In general, the community applying for the grant must be participating in the NFIP. Table A-3 shows the eligible subapplicants for each aforementioned program.

Table A-2. Cost Share Requirements

Program	Mitigation Activity Grant (Percent of Federal/Non-Federal Share)*
<b>HMGP</b>	75/25
<b>PDM</b>	75/25
<b>PDM – subgrantee is small impoverished community</b>	90/10
<b>PDM – Tribal grantee is small impoverished community</b>	90/10
<b>FMA</b>	75/25
<b>FMA – severe repetitive loss property with Repetitive Loss Strategy</b>	90/10
<b>RFC</b>	100/0
<b>SRL</b>	75/25
<b>SRL – with Repetitive Loss Strategy</b>	90/10

\* These ratios were applicable as of February 2010. Please refer to the current fiscal year’s *Hazard Mitigation Assistance Unified Guidance: Hazard Mitigation Grant Program, Pre-Disaster Mitigation Program, Flood Mitigation Assistance Program, Repetitive Flood Claims Program, Severe Repetitive Loss Program* (also called *HMA Unified Guidance*) for relevant ratios when referencing this table. The current fiscal year’s *HMA Unified Guidance* can be found at <http://www.fema.gov/library/viewRecord.do?id=4225>.

Table A-3. Eligible Subapplicants

Subapplicant	HMGP	PDM	FMA	RFC	SRL
State agencies	yes	yes	yes	yes	yes
Tribal governments	yes	yes	yes	yes	yes
Local governments/communities	yes	yes	yes	yes	yes
Private non-profit organizations	yes	no	no	no	no

### A.2.3 Stage 3. Application Development

Individuals and businesses are not eligible to apply for HMA funds, so individual homeowners must work with their local governments to develop a complete project subapplication on their behalf. Local governments may submit a retrofit project for a single home as an individual subapplication or combine it with other homes as part of an aggregate subapplication (subject to program restrictions). Aggregating benefit and cost values is allowed for multiple structures if they are all vulnerable to damage as a result of similar hazard conditions. Users of this document should refer to the latest *HMA Unified Guidance* for information on aggregating projects in an application.

Key elements for residential flood mitigation applications include:

- identify the property to be mitigated;
- identify key project personnel and roles, such as design professional and contractor;
- select an eligible project (see Table A-1);
- have a professional inspect the structure to verify that the project can be implemented (if possible; if not done at this stage, it must be done during Stage 4, Project Implementation);
- develop a project cost estimate and work schedule;
- conduct a benefit-cost analysis (BCA) using FEMA's BCA software (refer to Appendix B for additional information); if the benefit-cost ratio (BCR) is 1.0 or more, the project is cost-effective. FEMA requires a BCR of 1.0 or greater for funding; and
- ensure that properties located in designated SFHAs will obtain flood insurance and that this condition will be recorded on the property deed.

The local government submits the subapplication to the State. The State then selects projects based on its priorities and submits applications to FEMA for review. FEMA reviews the projects for eligibility, completeness, engineering feasibility, cost-effectiveness, cost reasonableness, and environmental and historic preservation documentation. The review process also confirms that all hazard mitigation activities adhere to all relevant statutes, regulations, and program requirements, including other applicable Federal, State, Indian Tribal, and local laws, implementing regulations, and executive orders, which are detailed in the *HMA Unified Guidance*. Once FEMA approves and awards the project, the grant funds are distributed by the State to the local governments, who will distribute it to individuals, as appropriate. No construction activities should begin until after the money has been awarded because HMA funding is not available for activities initiated or completed prior to award or final approval.

### **A.2.4 Stage 4. Project Implementation**

Once the State has awarded the funds to the local government, the next stage in the process is project implementation. HMA projects have to be completed within a specific amount of time called a period of performance, which is usually not more than 36 months. The homeowner or local government should secure the professional services of a contractor or an engineer at this stage to develop a detailed construction plan. If the scope of work or cost estimate changes as a result, consult the *HMA Unified Guidance* for direction on how to revise the scope of work prior to construction.

During the period of performance, the local government must maintain a record of work and expenditures for the quarterly reports that the State submits to FEMA. The basic steps for implementing an HMA mitigation flood retrofit project are:

1. Have a professional inspect the structure to verify that the project can be implemented (unless already completed during Stage 3, Application Development);
2. Finalize selection of viable project (unless already completed during Stage 3, Application Development);
3. Secure professional services to complete the approved project;
4. Complete installation of the approved hazard mitigation; and
5. Inspect the completed hazard mitigation elements and verify other program requirements.

### **A.2.5 Stage 5. Project Closeout**

Once the project has been completed, a professional should conduct a final verification to ensure that the project was implemented as intended. This will allow project closeout documentation and confirm that the building provides the desired level of protection. In addition, the State or the FEMA Region will verify that the work was completed in accordance with the approved scope of work and closeout procedures. If the house is located in an SFHA, the local government must provide documentation of flood insurance for the structure and a copy of the recorded deed amendment. The *HMA Unified Guidance* should be referenced to ensure all closeout requirements are addressed.

## A.3 Resources

Links to FEMA Funding Resources	
Increased Cost of Compliance (includes a link to FEMA 301, <i>NFIP Increased Cost Compliance [ICC] Coverage: Guidance for State and Local Officials</i> ) (FEMA, 2003)	<a href="http://www.fema.gov/plan/prevent/floodplain/ICC.shtm">http://www.fema.gov/plan/prevent/floodplain/ICC.shtm</a> <a href="http://www.fema.gov/library/viewRecord.do?fromSearch=fromsearch&amp;id=1532">http://www.fema.gov/library/viewRecord.do?fromSearch=fromsearch&amp;id=1532</a>
HMA Overview (includes link to most recent <i>HMA Unified Guidance</i> )	<a href="http://www.fema.gov/government/grant/hma/index.shtm">http://www.fema.gov/government/grant/hma/index.shtm</a>
HMA Policies	<a href="http://www.fema.gov/government/grant/hma/policy.shtm">http://www.fema.gov/government/grant/hma/policy.shtm</a>
HMGP	<a href="http://www.fema.gov/government/grant/hmgp/index.shtm">http://www.fema.gov/government/grant/hmgp/index.shtm</a>
PDM	<a href="http://www.fema.gov/government/grant/pdm/index.shtm">http://www.fema.gov/government/grant/pdm/index.shtm</a>
FMA	<a href="http://www.fema.gov/government/grant/fma/index.shtm">http://www.fema.gov/government/grant/fma/index.shtm</a>
RFC	<a href="http://www.fema.gov/government/grant/rfc/index.shtm">http://www.fema.gov/government/grant/rfc/index.shtm</a>
SRL	<a href="http://www.fema.gov/government/grant/srl/index.shtm">http://www.fema.gov/government/grant/srl/index.shtm</a>
Mitigation Planning	<a href="http://www.fema.gov/plan/mitplanning">http://www.fema.gov/plan/mitplanning</a>
Benefit-Cost Analysis	<a href="http://www.fema.gov/government/grant/bca.shtm">http://www.fema.gov/government/grant/bca.shtm</a>
Environmental Planning and Historic Preservation (EHP)	<a href="http://www.fema.gov/plan/ehp/index.shtm">http://www.fema.gov/plan/ehp/index.shtm</a>
HMA Helpline	Telephone: 866-222-3580 E-mail: <a href="mailto:hmagrantshelpline@dhs.gov">hmagrantshelpline@dhs.gov</a>

## A.4 References

- FEMA, 2003. *NFIP Increased Cost Compliance (ICC) Coverage: Guidance for State and Local Officials*. FEMA 301.
- FEMA. 2010. *FY2011 Hazard Mitigation Assistance Unified Guidance: Hazard Mitigation Grant Program, Pre-Disaster Mitigation Program, Flood Mitigation Assistance Program, Repetitive Flood Claims Program, Severe Repetitive Loss Program. (HMA Unified Guidance)*. June 1, 2010. <http://www.fema.gov/library/viewRecord.do?id=3649>



## APPENDIX B

# Understanding the FEMA Benefit-Cost Analysis Process

The Stafford Act authorizes the President to establish a program to provide technical and financial assistance to state and local governments to assist in the implementation of hazard mitigation measures that are cost effective and designed to substantially reduce injuries, loss of life, hardship, or the risk of future damage and destruction of property. To evaluate proposed hazard mitigation projects prior to funding FEMA requires a Benefit-Cost Analysis (BCA) to validate cost effectiveness. BCA is the method by which the future benefits of a mitigation project are estimated and compared to its cost. The end result is a benefit-cost ratio (BCR), which is derived from a project's total net benefits divided by its total project cost. The BCR is a numerical expression of the cost effectiveness of a project. A project is considered to be cost effective when the BCR is 1.0 or greater, indicating the benefits of a prospective hazard mitigation project are sufficient to justify the costs. Although the preparation of a BCA is a technical process, FEMA has developed software, written materials, and training to support the effort and assist with estimating the expected future benefits over the useful life of a retrofit project. It is imperative to conduct a BCA early in the project development process to ensure the likelihood of meeting the cost-effective eligibility requirement in the Stafford Act.

## B.1 Risk

Risk is defined in terms of expected probability and frequency of the hazard occurring, the people and property exposed, and the potential consequences. To estimate future damages (and the benefits of avoiding them), the probabilities of future events must be considered. The probabilities of future events profoundly affect whether a proposed retrofit project is cost effective. For example, the benefits of avoiding flood damage for a building in the 10-percent-annual-chance of flooding floodplain will be enormously greater than the benefits of avoiding flood damage for an identical building situated at the 0.001-percent-annual-chance of flooding level. In addition to the probability of the future flood events, it is just as important to consider the consequences associated with said event on a building. Estimated flood damages for a one-story building will typically be greater than that of a multi-story building or a building with a closed versus open foundation. The damages sustained by existing buildings exposed to flood hazards include site damage, structural and



nonstructural building damage, destruction or impairment of service equipment, and loss of contents. These types of damage, along with loss of function are avoided if buildings are located away from flood hazard areas and/or built to exceed the minimum requirements.

Many people may not be aware of the hazards that could affect their property and may not understand the risk they assume through decisions they make regarding their property. Property owners must understand how the choices they make could potentially reduce the risk of it being damaged by natural hazards. Property owners often misunderstand their risk; therefore, risk communication is critical to help them understand the risk that they assume. One common misperception is the 1-percent-annual-chance flood, or 100-year flood. There is a 1-percent chance each year of a flood that equals or exceeds the 100-year flood event elevation. Many property owners believe that being in the 1-percent-annual-chance floodplain means that there is only a 1-percent chance of ever being flooded, which they deem a very small risk. Or, they may believe that the 100-year flood can only happen once every 100 years. Unfortunately, these misperceptions result in a gross underestimation of their flood risk. In reality, over the course of a 30-year mortgage, a residential building within the Special Flood Hazard Area has a 26-percent chance of being damaged by a flood, compared to a 10-percent chance of fire or 17-percent chance of burglary. The discussion of risk with the homeowner can be difficult. It is important to find methods to convey the natural hazard risks for a site and how those risks may be addressed by retrofitting the building. The best available information should be examined, including FEMA Flood Insurance Rate Maps (FIRM), records of historical flooding, and advice from local experts and others who can evaluate flood risks.

## B.2 Benefits

The benefits considered in a retrofitting measure are the future damages or losses that are expected to be avoided as a result of the proposed mitigation project. Benefits cannot be determined exactly because the precise number and severity of future flood events is unknown. As a result, benefits are estimated based on experienced or hypothetical flood events of various magnitudes. Benefits for flood retrofit projects typically fall into the following categories:

- **Building:** reflect damages to the structure and are typically estimated using a depth damage function (DDF) and the building replacement value or historical damage records (e.g., flood insurance claim data); Figure B-1 illustrates that as floodwaters rise, more damage is done to the structure.
- **Content:** reflect damages to the contents within a building and are typically estimated using a DDF and the contents value or historical damage records (e.g., flood insurance claim data).
- **Displacement:** reflect the extra costs incurred when occupants of a residence are displaced to temporary housing due to a flood event. Displacement costs may be incurred for residential, commercial, or public buildings. Displacement occurs only when damages to a structure are sufficiently severe that the structure cannot be repaired with occupants in place.



### NOTE

A depth damage function (DDF) is an estimation of direct damage to the building based on a depth of flooding calculated as the percent damage to structures. DDFs are compiled from a variety of sources, including FEMA and the U.S. Army Corps of Engineers (USACE). DDFs typically vary based on the building type (i.e., one-story versus two-story), foundation (i.e., open versus closed), and occupancy type (i.e., residential versus commercial).

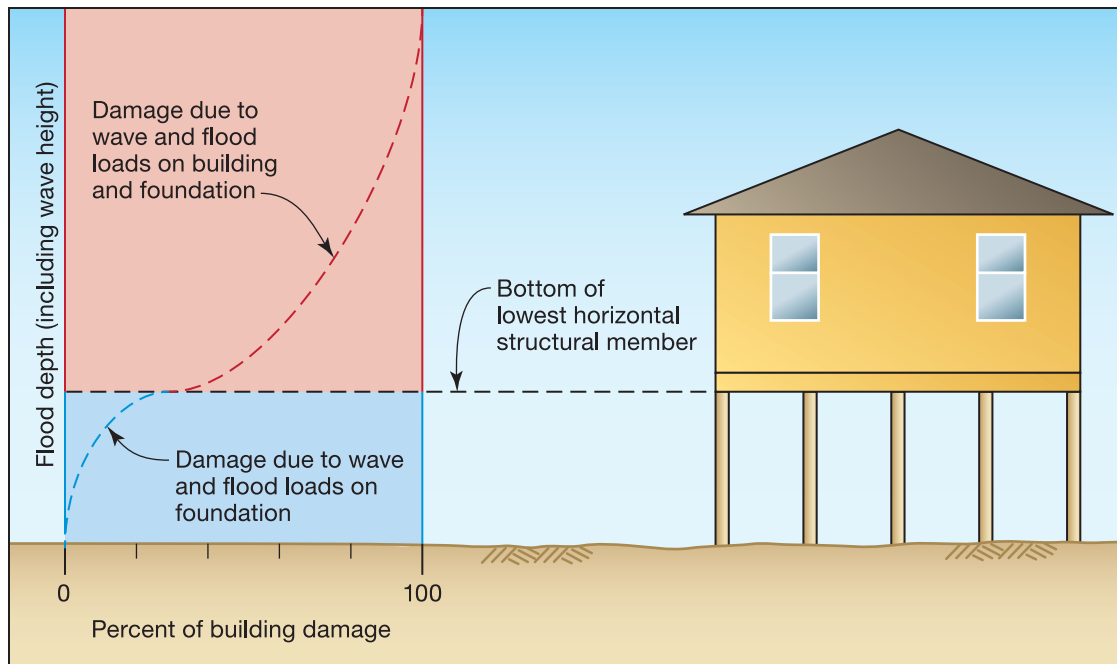

Figure B-1. The graph on the left illustrates how increases in flood depths increase the value of the DDF. The DDF is a relationship between the flood depth and the finished floor elevation of the building and not the elevation of the adjacent ground.

- **Loss of Business or Rental Income:** reflect the impact that may occur when damages are severe enough to result in a temporary closure of a business operating within a facility and estimated based on the net income lost during that closure.
- **Value of Service:** reflect the loss of function of a facility and quantify the service typically provided from the structure. Typical services include public services like law enforcement, fire rescue, medical, general government administrative operations, and public library, as well as utilities like electricity and water treatment.
- **Other:** reflect damages that are not usually estimated in the previous categories. Some typical benefits may include debris removal costs and emergency management costs.

### B.3 Estimating Benefits

The calculation of benefits for a proposed mitigation project entails estimating the present value of the sum of the expected annual damages over the useful life. The process takes into consideration:

- probabilities of various levels of flooding events and associated damages;
- useful lifetime of the mitigation project; and
- time value of money.

Some helpful terms to consider when estimating benefits are:

- *Expected annual damages* are the damages per year expected over the life of the structure or useful life of the mitigation project. “Expected annual” does not mean that these damages will occur every year.
- *Scenario damages* indicate the estimated damages that would result from a single flood of a particular depth at the building under evaluation. For example, the scenario damages for a 3-foot flood are the expected damages and losses each time a 3-foot flood occurs at a particular site. Scenario damages do not depend on the probability of floods at that location.
- *Historical damages* are based on actual recorded damages (versus being estimated) and typically associated with a flood frequency to help estimate the probability of occurrence.

The scenario (or historical) damages and the expected annual damages before mitigation provide, in combination, a complete picture of the vulnerability of the building to flood damage before undertaking a mitigation project. Expected annual damages will generally be much smaller than scenario or historical damages because they are multiplied by the probabilities of occurrence. A building with high expected annual damages means that not only are scenario damages high, but also that flood probabilities are relatively high. If expected annual damages are high, then there will be high potential benefits in avoiding such damages. Damages after mitigation depend on the effectiveness of the mitigation measure in avoiding damages. The expected annual damages and losses after mitigation also depend very strongly on the degree of flood risk at the site under evaluation. For some mitigation projects, such as acquisition, the scenario damages and expected annual losses after mitigation will be zero. For other mitigation projects, such as elevation or flood barriers, scenario damages, and expected annual losses after mitigation will be lower than before mitigation, but there is always some chance of flooding so the after mitigation damages cannot be zero.

The expected annual benefit for a project is given by Equation B-1.



**EQUATION B-1: EXPECTED ANNUAL BENEFIT**

$$EAB = EAD_{\text{Before Mitigation}} - EAD_{\text{After Mitigation}}$$

where:

- $EAB$  = Expected annual benefit
- $EAD_{\text{Before Mitigation}}$  = Expected annual damages before mitigation
- $EAD_{\text{After Mitigation}}$  = Expected annual damages after mitigation

In order to compare the future benefits to the current cost of the proposed mitigation project, a discount rate is applied over the life of the project to calculate the net present value of the expected annual benefits. For FEMA-funded mitigation projects, the discount rate is set by the Office of Management and Budget. Equation B-2 shows how to calculate the project benefits using the annual discount rate.



## EQUATION B-2: PROJECT BENEFITS

$$B = EAB \left[ \frac{1 - (1 + r)^{-T}}{r} \right]$$

where:

$B$  = project benefits

$EAB$  = total expected annual net benefit

$r$  = annual discount rate used to determine net present value of benefits

$T$  = estimated time the project will be effective, Project Useful Life

To evaluate cost effectiveness, a project's total net benefits are divided by its total project cost, resulting in a project  $BCR$ , as shown in Equation B-3. A project is considered to be cost effective when the  $BCR$  is greater than or equal to 1.0, indicating the benefits are sufficient to justify the costs.



## EQUATION B-3: BENEFIT-COST RATIO

$$BCR = \frac{\text{Project Benefits}}{\text{Project Costs}}$$

where:

$BCR$  = benefit-cost ratio

$\text{Project Benefits}$  = total project net benefits

$\text{Project Costs}$  = total project cost

## B.4 FEMA BCA Software

FEMA's BCA program is a key mechanism used by FEMA and other agencies to evaluate certain hazard mitigation projects to determine eligibility and assist in Federal funding decisions. Visit <http://www.bcahelpline.com/> for the latest BCA guidelines, policies, software program, user guides, training materials, and other resources, including <http://www.fema.gov/government/grant/bca.shtm#0>.



## APPENDIX C

# Sample Design Calculations

This appendix presents design examples of the retrofitting techniques for elevation, dry floodproofing, wet floodproofing, and construction of a floodwall in a residential setting. Examples C1 through C5 are a set of examples that illustrate the elevation of a single-story home with a crawlspace. Example C6 demonstrates how to size a sump pump for dry floodproofing. Example C7 shows how to calculate both the net buoyancy force exerted on a liquid propane tank in a wet floodproofing scenario and the volume of concrete needed to offset the buoyancy force. The final example, Example C8, demonstrates how to design a cantilevered floodwall to protect a residence subject to 3 feet of flooding. Please note that Examples C6 through C8 do not use the same example home presented in Examples C1 through C5, but are instead standalone examples.

The analyses and design solutions presented in this appendix apply to the example problems only. A licensed design professional should be engaged for actual projects involving the residential flood retrofitting techniques presented herein.



## Elevation

### Given or Obtained from the Field Investigation:

The owner of a single-story crawlspace home intends to elevate the structure to eliminate a repetitive flooding hazard. Her desire is to raise the structure one full story (8 feet) and use the lower level for parking and storage. She contracted with a local engineer to perform the design. The engineer's investigation revealed the following information about the existing structure:

- crawlspace home has 8-inch CMU ungrouted foundation (no vertical reinforcement);
- the first-floor elevation is 2 feet above the surrounding grade (which is level);
- the property is located in a FEMA-designated floodplain (Zone AE) and the base flood elevation (BFE) is 4 feet above ground level;
- floodwater velocities during a base flood will average 6 feet per second;
- floodwater flows parallel to the side elevation and impact the front elevation;
- floodwater debris hazard exists and is characterized as normal;
- the structure is classified as a pre-Flood Insurance Rate Map (pre-FIRM) structure with no existing flood openings; and
- local regulations require an additional 1 foot of freeboard above the 100-year flood elevation.

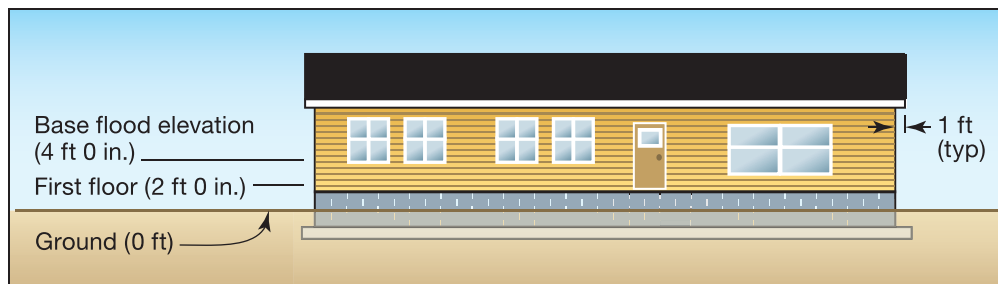



**Additional Information on Existing House:**

- wood-frame house 30 feet x 60 feet; and
- gable roof with 4:12 slope.

Per International Residential Code (IRC) and American Society of Civil Engineers (ASCE) 7:

- 90 miles per hour Basic Wind Speed (3-second gust);
- flat open terrain surrounding house;
- wind Exposure Category C, enclosed building;
- seismic importance factor  $I_e = 1.0$ ;  $S_{DS} = 0.2$ ; and
- ground snow load of 20 lb/ft<sup>2</sup>.

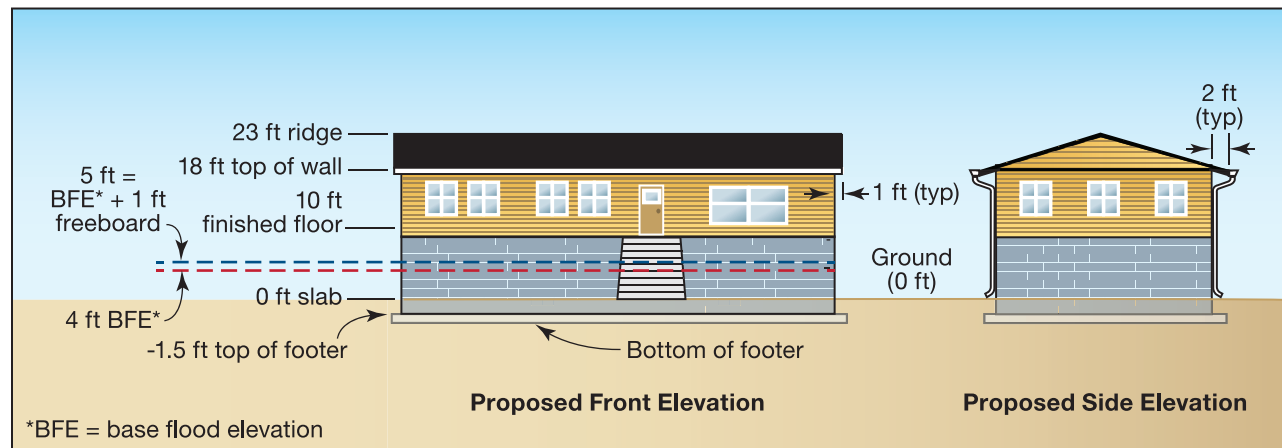

Extended foundation walls are proposed to be constructed of 8-inch-thick concrete masonry units. The existing footing is 2 feet wide by 1 foot thick concrete reinforced with (3) #4 rebar continuously. Top of footing is 18 inches below grade; soil type is stiff residual silts. New slab-on-grade will be 3½ to 4 inches thick and set at grade.

Interior walls of the living area (elevated) are composed of 2x4 studs at 16 inches on center (o.c.) with plaster on each side. Exterior walls have 2x4 studs at 16 inches o.c., plaster on the inside, and sheathing and wood siding on the exterior walls are insulated with fiberglass insulation.

First floor framing consists of 2x12s at 16 inches o.c. supported by the exterior long walls and a center support. Floor coverings are hardwood (oak) with a ¾-inch plywood subfloor. There are 10 inches of insulation between the joists. A gypsum ceiling is planned for the proposed lower area.

Roof framing consists of pre-engineered wood trusses at 16 inches o.c. The top chord consists of 2x6s and the web and bottom chord consist of 2x4s. The roof is fiberglass shingles with felt on ½-inch plywood. The ceiling is ½-inch plaster with ½-inch plywood backup. There are 16 inches of fiberglass insulation above the ceiling.



### EXAMPLE C1. CALCULATE VERTICAL LOADS

#### Given:

Per original Sample Calculation Statement:

- Property is located in a FEMA-designated floodplain (Zone AE) and is subject to a 100-year flood 4 ft in depth above ground level;
- Local regulations require an additional 1 ft of freeboard above the 100-year flood elevation; and
- Field investigation information and additional information on the site

#### Find:

1. Design flood elevation (DFE)
2. Floodproofing design depth
3. Total vertical flood load due to buoyancy
4. Vertical loads on the house (excluding buoyancy force)
5. Total structure dead weight
6. Is the total structural dead weight sufficient to prevent flotation of the house from the buoyancy force during a flood event?

**Solution for #1:** To find the DFE, use Equation 4-2:

$$DFE = FE + f = 4\text{ ft} + 1\text{ ft} = \mathbf{5\text{ ft}}$$

*NOTE: The DFE calculated includes freeboard.*

**Solution for #2:** To find the floodproofing design depth over which flood forces will be considered, use Equation 4-3:

$$H = DFE - GS = 5\text{ ft} - 0\text{ ft} = \mathbf{5\text{ ft}}$$

**Solution for #3:** The buoyancy force can be found as follows:

- The calculation of buoyancy forces and comparison with structure weight is a critical determination of this problem. While buoyancy of the first floor is not an issue (since it is elevated 5 ft above the DFE), buoyancy of the entire structure (slab, foundation walls, and superstructure) must be checked if dry floodproofing is being considered for the lower level. If buoyancy forces control, or if the slab and walls cannot withstand the hydrostatic and other design flood forces, dry floodproofing of the lower level is not applicable. Using Equation 4-6:

$$F_{\text{buoy}} = \gamma_w AH = (62.4\text{ lb/ft}^3)(30\text{ ft})(60\text{ ft})(5\text{ ft}) = \mathbf{561.6\text{ kips}}$$

**EXAMPLE C1. CALCULATE VERTICAL LOADS (continued)**

**Solution for #4:** The vertical loads can be determined as follows:

**Calculate Structure Weight by Level**

- Tabulate Dead Loads by Floor (based on ASCE 7-10, Table C3-1)

**Roof:** 2x6 Top Chord and 2x4 Web and Bottom

Shingles – Asphalt – 1 layer: 2.0 lb/ft<sup>2</sup>

Felt: 0.7 lb/ft<sup>2</sup>

Plywood – 32/16–1/2 in.: 1.5 lb/ft<sup>2</sup>

Trusses @ 16 in. o.c.: 5.0 lb/ft<sup>2</sup>

$$Total = 2.0 \text{ lb/ft}^2 + 0.7 \text{ lb/ft}^2 + 1.5 \text{ lb/ft}^2 + 5.0 \text{ lb/ft}^2 = 9.2 \text{ lb/ft}^2$$

**First Floor Ceiling:**

Insulation – 16 in. of fiberglass: 8.0 lb/ft<sup>2</sup>

1/2 in. plywood: 1.5 lb/ft<sup>2</sup>

1/2 in. plaster and lath: 10.0 lb/ft<sup>2</sup>

Misc., heating, electrical, cabinets: 2.0 lb/ft<sup>2</sup>

$$Total = 8.0 \text{ lb/ft}^2 + 1.5 \text{ lb/ft}^2 + 10.0 \text{ lb/ft}^2 + 2.0 \text{ lb/ft}^2 = 21.5 \text{ lb/ft}^2$$

**First Floor:**

Oak Floor: 4.0 lb/ft<sup>2</sup>

Subfloor – 3/4 in. plywood: 3.0 lb/ft<sup>2</sup>

Joists (2x12): 4.0 lb/ft<sup>2</sup>

Insulation – 10 in. fiberglass: 5.0 lb/ft<sup>2</sup>

Misc., piping, electrical: 3.0 lb/ft<sup>2</sup>

Gypsum ceiling – 1/2 in.: 2.5 lb/ft<sup>2</sup>

$$Total = 4.0 \text{ lb/ft}^2 + 3.0 \text{ lb/ft}^2 + 4.0 \text{ lb/ft}^2 + 5.0 \text{ lb/ft}^2 + 3.0 \text{ lb/ft}^2 + 2.5 \text{ lb/ft}^2 = 21.5 \text{ lb/ft}^2$$

**Walls:**

Interior – wood stud, plaster each side: 20 lb/ft<sup>2</sup>

Exterior – 2x4 @ 16 in. o.c., plaster insulation, wood siding: 18 lb/ft<sup>2</sup>

Lower Level – 8 in. masonry, reinforcement at 48 in. o.c.: 46 lb/ft<sup>2</sup>

- Now to determine the total weights by level

**Roof:** Using the roof overhang of 2 ft

$$Surface Area = (15.81 \text{ ft} + 2 \text{ ft})(60 \text{ ft} + 2 \text{ ft})(2) = 2,208 \text{ ft}^2$$

$$Projected Area = \left[ 15 \text{ ft} + 2 \text{ ft} \left( \frac{15}{15.81} \right) \right] (60 \text{ ft} + 2 \text{ ft})(2) = 2,095 \text{ ft}^2$$

$$\text{Shingles: } 2,208 \text{ ft}^2 (2 \text{ lb/ft}^2) = 4,416 \text{ lbs}$$

$$\text{Felt: } 2,208 \text{ ft}^2 (0.7 \text{ lb/ft}^2) = 1,546 \text{ lbs}$$

$$\text{Plywood: } 2,208 \text{ ft}^2 (1.5 \text{ lb/ft}^2) = 3,312 \text{ lbs}$$

$$\text{Truss: } 2,095 \text{ ft}^2 (5 \text{ lb/ft}^2) = 10,475 \text{ lbs}$$

**EXAMPLE C1. CALCULATE VERTICAL LOADS** (continued)

Gable end walls:  $150\text{ft}^2(18\text{lb}/\text{ft}^2) = 2,700\text{lbs}$

$Total = 4,416\text{lbs} + 1,546\text{lbs} + 3,312\text{lbs} + 10,475\text{lbs} + 2,700\text{lbs} = \mathbf{22,449\text{ lbs}}$  for roof weight

**First Floor Ceiling:**

Area =  $(60\text{ft})(30\text{ft}) = 1,800\text{ft}^2$

Insulation:  $(1,800\text{ft}^2)(8\text{lb}/\text{ft}^2) = 14,400\text{lbs}$

Plywood:  $(1,800\text{ft}^2)(1.5\text{lb}/\text{ft}^2) = 2,700\text{lbs}$

Plaster:  $(1,800\text{ft}^2)(10\text{lb}/\text{ft}^2) = 18,000\text{lbs}$

Miscellaneous:  $(1,800\text{ft}^2)(2\text{lb}/\text{ft}^2) = 3,600\text{lbs}$

$Total = 14,400\text{lbs} + 2,700\text{lbs} + 18,000\text{lbs} + 3,600\text{lbs} = \mathbf{38,700\text{ lbs}}$  for the first floor ceiling

**Walls:**

Exterior:  $(180\text{ft})(4\text{ft})(18\text{lb}/\text{ft}^2) = 12,960\text{lbs}$

Interior:  $(157\text{ft})(4\text{ft})(20\text{lb}/\text{ft}^2) = 12,560\text{lbs}$

$Total = 12,960\text{lbs} + 12,560\text{lbs} = \mathbf{25,520\text{ lbs}}$  for the walls

**Calculating the subtotal for the roof, first floor ceiling, and walls**

$W_1 = 22,449\text{lbs} + 38,700\text{lbs} + 25,520\text{lbs} = 86,669\text{lbs}$

**First Floor Including Lower Level:** Each of the components has the following area:

Area =  $(60\text{ft})(30\text{ft}) = 1,800\text{ft}^2$

**Floors:**

Oak Floor:  $(1,800\text{ft}^2)(4\text{lb}/\text{ft}^2) = 7,200\text{lbs}$

Subfloor:  $(1,800\text{ft}^2)(3\text{lb}/\text{ft}^2) = 5,400\text{lbs}$

Joists:  $(1,800\text{ft}^2)(4\text{lb}/\text{ft}^2) = 7,200\text{lbs}$

Insulation:  $(1,800\text{ft}^2)(5\text{lb}/\text{ft}^2) = 9,000\text{lbs}$

Miscellaneous:  $(1,800\text{ft}^2)(3\text{lb}/\text{ft}^2) = 5,400\text{lbs}$

$Total = 7,200\text{lbs} + 5,400\text{lbs} + 7,200\text{lbs} + 9,000\text{lbs} + 5,400\text{lbs} = \mathbf{34,200\text{ lbs}}$  for the floors

**Ceiling:**

$(1,800\text{ft}^2)(2.5\text{lb}/\text{ft}^2) = \mathbf{4,500\text{ lbs}}$  for the ceiling

**Walls:**

Exterior:  $(180\text{ft})(4\text{ft})(18\text{lb}/\text{ft}^2) = 12,960\text{lbs}$

Interior:  $(157\text{ft})(4\text{ft})(20\text{lb}/\text{ft}^2) = 12,560\text{lbs}$

Lower level above proposed dry floodproofed slab:  $(180\text{ft})(9\text{ft})(46\text{lb}/\text{ft}^2) = 74,520\text{lbs}$

Weight of water per square foot of masonry wall:  $(\frac{8}{12}\text{ft})(62.4\text{lb}/\text{ft}^3) = 41.6\text{lb}/\text{ft}^2$

Lower level below proposed dry floodproofed slab:  $(180\text{ft})(1.5\text{ft})(46 - 41.6\text{lb}/\text{ft}^2) = 1,188\text{lbs}$

**EXAMPLE C1. CALCULATE VERTICAL LOADS (concluded)**

$Total = 12,960 \text{ lbs} + 12,560 \text{ lbs} + 74,520 \text{ lbs} + 1,188 \text{ lbs} = \mathbf{101,228 \text{ lbs}}$  for the walls

**Footing:**

$(180 \text{ ft})(2 \text{ ft})(1 \text{ ft})(150 - 62.4 \text{ lb/ft}^2) = \mathbf{31,536 \text{ lbs}}$  for footing

**Slab:**

$(1,800 \text{ ft}^2)(0.33 \text{ ft})(150 \text{ lb/ft}^3) = \mathbf{89,100 \text{ lbs}}$  for the slab

**Calculating the subtotal for the floor, ceiling, walls, footing, and slab:**

$W_2 = 34,200 \text{ lbs} + 4,500 \text{ lbs} + 101,228 \text{ lbs} + 31,536 \text{ lbs} + 89,100 \text{ lbs} = 260,564 \text{ lbs}$

**Solution for #5:** The total dead load of the structure can be found by adding the two above subtotals:

$W = W_1 + W_2 = 86,669 \text{ lbs} + 260,564 \text{ lbs} = \mathbf{347,233 \text{ lbs}}$

**Solution for #6:** To determine if the dead load (structure weight) from the house is sufficient to prevent overturning from the buoyancy force, compare the buoyancy force to the structure weight:

$$W \geq F_b$$

$347,233 \text{ lbs} \leq 561,600 \text{ lbs}$

$347 \text{ kips} \leq 562 \text{ kips N.G. (No Good)}$

**Therefore, the structural weight is not enough to prevent floatation of house during design flooding events. Additionally, in the case that the dead weight of the elevated structure could resist the buoyancy forces, the new slab would have to be designed to transfer buoyancy loads to exterior walls without cracking.**

*NOTE: Buoyancy forces control the building (if dry floodproofed) during a flooding event unless structural measures, such as floor anchors or additional slab mass, or non-structural measures such as allowing the lower level to flood, are utilized to offset/equalize the buoyancy forces.*

*In our example, since buoyancy controls and the magnitude of the project represent a substantial improvement, the homeowner is required to allow the lower level to flood by incorporating vent openings in the foundation wall. While this action will equalize hydrostatic pressures on the foundation walls, hydrodynamic and flood-borne debris impact forces will still apply.*

*Section 5E.1.2.1 of FEMA Technical Bulletin 1-08 provides the following guidance on flood openings: "A minimum of two openings shall be provided on different sides of each enclosed area, having a total net area of not less than 1 square inch for every square foot of enclosed area subject to flooding." The enclosed area of the example building is 1,800 square feet (60 feet x 30 feet); therefore, a minimum of two flood openings with a minimum combined area of 1,800 square inches shall be installed 12 inches or less above grade.*



### EXAMPLE C2. CALCULATE LATERAL LOADS

#### Given:

Per original Sample Calculation Statement:

- Floodwater velocities in the area of the house average 6 ft/sec
- Floodwater flows parallel to front elevation and impact side elevation
- Floodwater debris hazard exists and is characterized as normal
- Flood openings will be installed in the foundation walls
- $V$  = basic wind speed = 90 mph
- Exposure Category C
- $I$  = importance factor = 1.00 for residential construction
- $S_{DS} = 3.0$  sec

Additional information for this example per Equation 4-13, Table 4-6 and Table 4-7:

- $W$  = weight of debris = 1,000 lb
- $C_D$  = depth coefficient = 0.75
- $C_B$  = blockage coefficient = 0.6
- $C_{str}$  = building structure coefficient = 0.8

#### Find:

1. Lateral hydrostatic force
2. Lateral hydrodynamic forces
3. Lateral debris impact forces
4. Lateral forces for wind perpendicular and parallel to the main ridge
5. Seismic forces

**Solution for #1:** To calculate lateral hydrostatic forces from 5 ft of water moving at 6 ft/sec:

First, calculate hydrostatic force from 5 ft of freestanding water using Equation 4-4.

$$f_{sta} = \frac{1}{2} P_b H = \frac{1}{2} \gamma_w H^2$$

$$f_{sta} = (0.5) \left( 62.4 \frac{\text{lb}}{\text{ft}^3} \right) (5 \text{ ft})^2$$

$$f_{sta} = 780 \text{ lb/ft acting at } 1.67 \text{ ft above ground surface}$$

**EXAMPLE C2. CALCULATE LATERAL LOADS** (continued)

In the “additional information” provided in the description of the house, the top of footing is 24 in. below ground surface and the soil type is stiff residual clay ( $S = 82 \text{ lb/ft}^3$  per Table 4-3).

Calculate submerged soil and water forces per Equation 4-5.

$$f_{dif} = \frac{1}{2}(S - \gamma_w)D^2$$

$$f_{dif} = \frac{1}{2}(82 \text{ lb/ft}^3 - 62.4 \text{ lb/ft}^3)(1.5 \text{ ft})^2$$

$$f_{dif} = 22.5 \text{ lb/ft acting at 0.75 ft below ground surface}$$

$f_{db}$  will be calculated in #2 to yield the force due to flowing water, using the equivalent hydrostatic method.

Finally, compute total lateral hydrostatic force using Equation 4-4, after removing the  $f_{db}$  term (which is being used in #2).

$$F_{sta} = f_{sta} + f_{dif}$$

$$F_{sta} = 0 \text{ lb/ft} + 22 \text{ lb/ft}$$

$$F_{sta} = \mathbf{22 \text{ lb/ft}}$$

**Solution for #2:** Since  $V < 10 \text{ ft/sec}$ , use Eq. 4-7 to convert hydrodynamic force to equivalent hydrostatic force

$$dh = \frac{C_d V^2}{2g}$$

Determine drag coefficient  $C_d$  by calculating  $\frac{b}{H}$  and using Table 4-5

$$\frac{b}{H} = \frac{30 \text{ ft}}{5 \text{ ft}} = 6$$

$$C_d = 1.25$$

$$dh = \frac{1.25 \left( 6 \frac{\text{ft}}{\text{sec}} \right)^2}{2 \left( 32.2 \frac{\text{ft}}{\text{sec}^2} \right)}$$

$$dh = 0.70 \text{ ft}$$

Convert the equivalent head to equivalent hydrostatic force.

From Equation 4-8:

$$f_{db} = \gamma_w (dh)H = P_{db}H$$

$$f_{db} = \left( 62.4 \frac{\text{lb}}{\text{ft}^3} \right) (0.70 \text{ ft})(5 \text{ ft})$$



**EXAMPLE C2. CALCULATE LATERAL LOADS** (continued)

$f_{db} = 218.4 \text{ lb/ft}$  acting at 2.5 ft above ground surface

Now to calculate total force due to flow velocity on the building face (upstream)  $F_d = f_{db}W$

$$F_d = \left(218.4 \frac{\text{lb}}{\text{ft}}\right)(30 \text{ ft})$$

$$F_d = 6,552 \text{ lbs} = 6.55 \text{ kips}$$

**Solution for #3:** To calculate lateral debris impact loads, use Equation 4-11:

$$F_i = WVC_D C_B C_{Str}$$

The parameters in Equation 4-11 are briefly discussed in Chapter 4 of this publication and discussed in greater detail in Chapter 8 of FEMA P-55 (Fourth Edition), *Coastal Construction Manual* (FEMA, 2011).

$$F_i = (1,000 \text{ lbs})(6 \text{ ft/sec})(0.75)(0.6)(0.8)$$

$$F_i = 2,160 \text{ lbs} = 2.16 \text{ kips}$$

*NOTE: Since vents are being used to equalize the hydrostatic pressure, the wall will be subject to a net load equal to the combined hydrodynamic and impact loads. The ability of the new foundation wall to withstand these forces is presented toward the end of Example C5.*

**Solution for #4:** To calculate lateral forces for wind perpendicular and parallel to the main ridge:

Since the house is being elevated, wind pressures will be increased on the building. Depending upon the amount of elevation, additional bracing of the roof or walls may be necessary.

**Reference:** International Residential Code (IRC) and ASCE 7

Basic Wind Speed has been determined to be 90 mph from the 2012 IRC and verified with the local building official. The method to determine lateral forces is the Directional Procedure per ASCE 7-10. Because ASCE 7-10 procedures and load combinations are used in this sample problem, the equivalent ASCE 7-10 wind speed must be used for the same geographical region. That wind speed is 115 mph (3-second gust).

From ASCE 7-10 Equation 27.3-1, calculate velocity pressure calculated at height  $z$  above ground ( $q_z$ ):

$$q_z = 0.00256 K_z K_{zt} K_d V^2$$

Compute  $q_z$  at two different heights:

- At  $z_1 = 15 \text{ ft}$
- At mean roof height  $z_2 = h = 18 \text{ ft} + \frac{5 \text{ ft}}{2} = 20.5 \text{ ft}$

**EXAMPLE C2. CALCULATE LATERAL LOADS** (continued)

From ASCE 7-10 Table 27.3-1, compute velocity pressure exposure coefficients ( $K_z$ ) at heights listed above:

- For  $z_1 = 15$  ft,  $K_{z_1} = 0.85$
- For  $z_2 = h = 20.5$  ft,  $K_{z_2} = K_h = 0.904$  by linear interpolation

Use topographic factor,  $K_{zt} = 1.0$  since house is surrounded by flat, open terrain

From ASCE 7-10 Table 26.6-1, use directionality factor,  $K_d = 0.85$  for buildings

$$q_{z_1} = 0.00256(0.85)(1.0)(0.85)(115 \text{ mph})^2$$

$$q_{z_1} = 24.5 \text{ lb/ft}^2$$

$$q_{z_2} = 0.00256(0.904)(1.0)(0.85)(115 \text{ mph})^2$$

$$q_{z_2} = 26.0 \text{ lb/ft}^2$$

Calculate Design Wind Pressures on Building Main Wind Force Resisting System, MWFRS ( $p$ ) using Equation 27.4-1 (ASCE 7-10)

$$p = qGC_p - q_i(GC_{pi})$$

From ASCE 7-10 Equation 27.3-1 use  $q = q_{z_1} = 24.5 \text{ lb/ft}^2$ , the velocity pressure computed for windward walls calculated at wall height  $z_1$  or  $z_2$  above ground ( $\text{lb/ft}^2$ )

From ASCE 7-10 Equation 27.3-1, use  $q = q_{z_1} = 26.0 \text{ lb/ft}^2$  for all other walls and roof surfaces ( $\text{lb/ft}^2$ )

From ASCE 7-10 Section 26.9.1, use gust effect factor  $G = 0.85$  for rigid structures

From ASCE 7-10 Figure 27.4-1, compute external pressure coefficients ( $C_p$ ) for the following scenarios:

- Perpendicular to the ridge, where:
  - a. For windward walls,  $C_p = 0.8$
  - b. For leeward walls,  $\frac{L}{B} = \frac{30 \text{ ft}}{60 \text{ ft}} = 0.5$ ,  $C_p = -0.5$
  - c. For windward roof,  $\frac{h}{L} = \frac{20.5 \text{ ft}}{30 \text{ ft}} = 0.683$ ,  $\theta = \tan^{-1}\left(\frac{4 \text{ ft}}{12 \text{ ft}}\right) = 18.4$ ,  $C_p = -0.61$  and  $-0.12$  by linear interpolation
  - d. For leeward roof,  $\frac{h}{L} = \frac{20.5 \text{ ft}}{30 \text{ ft}} = 0.683$ ,  $\theta = \tan^{-1}\left(\frac{4 \text{ ft}}{12 \text{ ft}}\right) = 18.4$ ,  $C_p = -0.58$  by linear interpolation

**EXAMPLE C2. CALCULATE LATERAL LOADS (continued)**

- Parallel to the ridge, where:

a. For windward walls,  $C_p = 0.8$

b. For leeward walls,  $\frac{L}{B} = \frac{60 \text{ ft}}{30 \text{ ft}} = 2$ ,  $C_p = -0.3$

c. For windward roof,  $\frac{h}{L} = \frac{20.5 \text{ ft}}{60 \text{ ft}} = 0.34$ ,  $\theta = \tan^{-1}\left(\frac{4 \text{ ft}}{12 \text{ ft}}\right) = 18.4^\circ$ ,  $C_p = -0.9$  for 0 to 20 ft from windward edge,  $C_p = -0.5$  for 20 to 40 ft from windward edge

From Equation 27.3-1, use velocity pressure calculated at mean roof height,  $q_h = q_i = 26.0 \text{ lb/ft}^2$

From Table 26.11-1, use internal pressure coefficients for enclosed buildings,  $GC_{pi} = \pm 0.18$

***MWFRS – Wind Perpendicular to Ridge***
**Walls:**

Windward:

$$p = (24.5 \text{ lb/ft}^2)(0.85)(0.8) - (26.0 \text{ lb/ft}^2)(0.18)$$

$$p = \mathbf{12.0 \text{ lb/ft}^2} \text{ (inward)}$$

$$p = (24.5 \text{ lb/ft}^2)(0.85)(0.8) - (26 \text{ lb/ft}^2)(-0.18)$$

$$p = \mathbf{21.3 \text{ lb/ft}^2} \text{ (inward)}$$

Leeward:

$$p = (26.0 \text{ lb/ft}^2)(0.85)(-0.5) - (26.0 \text{ lb/ft}^2)(0.18)$$

$$p = \mathbf{-15.7 \text{ lb/ft}^2} \text{ (outward)}$$

$$p = (26.0 \text{ lb/ft}^2)(0.85)(-0.5) - (26.0 \text{ lb/ft}^2)(-0.18)$$

$$p = \mathbf{-6.4 \text{ lb/ft}^2} \text{ (outward)}$$

**Roof:**

Windward:

$$p = (26.0 \text{ lb/ft}^2)(0.85)(-0.61) - (26.0 \text{ lb/ft}^2)(0.18)$$

$$p = \mathbf{-18.2 \text{ lb/ft}^2} \text{ (outward)}$$

$$p = (26.0 \text{ lb/ft}^2)(0.85)(-0.12) - (26.0 \text{ lb/ft}^2)(-0.18)$$

$$p = \mathbf{2.0 \text{ lb/ft}^2} \text{ (inward)}$$

Leeward:

$$p = (26.0 \text{ lb/ft}^2)(0.85)(-0.58) - (26.0 \text{ lb/ft}^2)(0.18)$$

$$p = \mathbf{-17.4 \text{ lb/ft}^2} \text{ (outward)}$$

$$p = (26.0 \text{ lb/ft}^2)(0.85)(-0.58) - (26.0 \text{ lb/ft}^2)(-0.18)$$

$$p = \mathbf{-8.1 \text{ lb/ft}^2} \text{ (outward)}$$

***MWFRS – Wind Parallel to Ridge***
**Walls:**

Windward:

$$p = (24.5 \text{ lb/ft}^2)(0.85)(0.8) - (26.0 \text{ lb/ft}^2)(0.18)$$

**EXAMPLE C2. CALCULATE LATERAL LOADS (continued)**

$$p = 12.0 \text{ lb/ft}^2 \text{ (inward)}$$

$$p = (24.5 \text{ lb/ft}^2)(0.85)(0.8) - (26.0 \text{ lb/ft}^2)(-0.18)$$

$$p = 21.3 \text{ lb/ft}^2 \text{ (inward)}$$

Leeward:

$$p = (26.0 \text{ lb/ft}^2)(0.85)(-0.3) - (26.0 \text{ lb/ft}^2)(0.18)$$

$$p = -11.3 \text{ lb/ft}^2 \text{ (outward)}$$

$$p = (26.0 \text{ lb/ft}^2)(0.85)(-0.3) - (26.0 \text{ lb/ft}^2)(-0.18)$$

$$p = -2.0 \text{ lb/ft}^2 \text{ (outward)}$$

**Roof:**

Windward, for distance from leading edge:

0 to 20 ft  $p = (26.0 \text{ lb/ft}^2)(0.85)(-0.90) - (26.0 \text{ lb/ft}^2)(0.18)$   
 $p = -24.6 \text{ lb/ft}^2 \text{ (outward)}$   
 $p = (26.0 \text{ lb/ft}^2)(0.85)(-0.90) - (26.0 \text{ lb/ft}^2)(-0.18)$   
 $p = -15.2 \text{ lb/ft}^2 \text{ (outward)}$

20 to 40 ft  $p = (26.0 \text{ lb/ft}^2)(0.85)(-0.5) - (26.0 \text{ lb/ft}^2)(0.18)$   
 $p = -15.7 \text{ lb/ft}^2 \text{ (outward)}$

40 to 60 ft  $p = (26.0 \text{ lb/ft}^2)(0.85)(-0.3) - (26.0 \text{ lb/ft}^2)(0.18)$   
 $p = -11.3 \text{ lb/ft}^2 \text{ (outward)}$

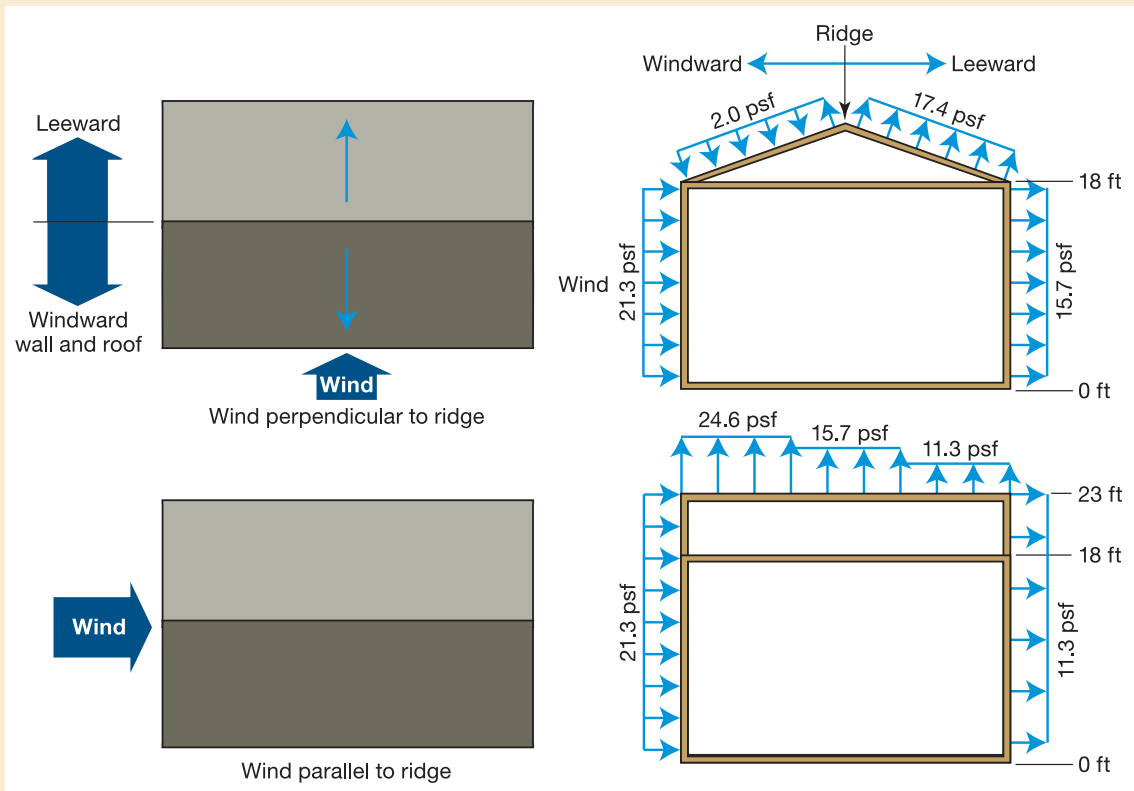

**EXAMPLE C2. CALCULATE LATERAL LOADS** (continued)

**Solution for #5:** To calculate the quantity and distribution of lateral seismic forces (base shear and vertical distribution):

Since the house is being elevated, the potential for seismic loading/overturning design loads will be increased on the home. Depending upon the amount of elevation, additional bracing of the roof or walls may be necessary.

**Reference:** ASCE 7-10 per Equivalent Lateral Force (ELF) procedure  
Per equation 12.8-1 in ASCE 7-10 and equation 12.8-2 in ASCE 7-10:

$$V = C_s W$$

$$C_s = \frac{S_{DS}}{\left(\frac{R}{I}\right)}$$

**Where:**

$W$  = effective seismic weight

$C_s$  = seismic response coefficient

$I$  = occupancy importance factor = 1 per ASCE 7-10 Section 11.5.1 and Table 1.5-2

$R$  = response modification factor

$S_{DS}$  = design spectral response acceleration parameter in the short period range

Now, per ASCE 7-10 Table 12.14-1 and equations 12.8-11 and 12.8-12 in ASCE 7-10:

$R = 2$  for ordinary reinforced masonry shear wall foundation

$R = 6.54$  for framed walls with plywood

$$F_x = C_{wx} V$$

$$C_{wx} = \frac{w_x h_x^k}{\sum_{i=1}^n w_i h_i^k}$$

$$C_s = \frac{S_{DS}}{\left(\frac{R}{I}\right)}$$

$$C_s = \frac{0.2}{\left(\frac{2}{1.0}\right)}$$

$$C_s = 0.1$$

$$V = C_s W$$

**Effective seismic weights:**

$$W_1 = w_{roof} = 86,669 \text{ lbs at roof/upper ceiling level}$$

**EXAMPLE C2. CALCULATE LATERAL LOADS (continued)**

Recalculate  $W_2 = w_{floor}$  without the effects of buoyancy on footing weight and lower foundation walls for conservative seismic condition.

Lower level masonry wall grouted at 48 in. o.c.:  $(180\text{ ft})(10.5\text{ ft})(46\text{ lb/ft}^2) = 86,940\text{ lbs}$  for the walls

**Footing:**

$(180\text{ ft})(2\text{ ft})(1\text{ ft})(150\text{ lb/ft}^2) = 54,000\text{ lbs}$  for footing

$W_2 = w_{floor} = 34,200\text{ lbs} + 4,500\text{ lbs} + 112,460\text{ lbs} + 54,000\text{ lbs} + 89,100\text{ lbs} = 294,260\text{ lbs}$  at first floor level (without buoyancy force on components below the slab)

$W = 294,260\text{ lbs} + 86,669\text{ lbs} = 380,929\text{ lbs} = \text{total effective seismic weight}$

$V = 0.1(380,929)\text{ lbs}$

$V = 38,093\text{ lbs}$

$h_{roof} = 18\text{ ft} = \text{height at roof/upper ceiling}$   $Total = 12,960\text{ lbs} + 12,560\text{ lbs} + 86,940\text{ lbs} = 112,460$

$h_{floor} = 10\text{ ft} = \text{height at first floor}$

$w_{roof} h_{roof} = (86,669\text{ lbs})(18\text{ ft})$

$w_{roof} h_{roof} = 1,560,042\text{ ft-lb}$

$w_{floor} h_{floor} = (294,260\text{ lbs})(10\text{ ft})$

$w_{floor} h_{floor} = 2,942,600\text{ ft-lb}$

$$C_{vroof} = \frac{1,560,042\text{ ft-lb}}{(1,560,042\text{ ft-lb}) + (2,942,600\text{ ft-lb})}$$

$C_{vroof} = 0.35$

$$C_{vfloor} = \frac{2,942,600\text{ ft-lb}}{(1,560,042\text{ ft-lb}) + (2,942,600\text{ ft-lb})}$$

$C_{vroof} = 0.65$

$F_{roof} = (0.35)(38,093\text{ lbs})$

$C_{vroof} = 13,332\text{ lbs}$

$F_{floor} = (0.65)(38,093\text{ lbs})$

$C_{vroof} = 24,760\text{ lbs}$

**EXAMPLE C2. CALCULATE LATERAL LOADS (concluded)**

NOTE: For summary, see below:

**Lateral Forces Perpendicular to Long Direction**

**Seismic**

Level	Height (ft) $h_x$	Level Weight (kips) $w_x$	$(w_x)(h_x)$	Lateral Force (kips) $F_x$	Level Shear (kips) $\Sigma F_x$
2	18	83.97	1,511	13.3	13.3
1	10	303.03	3,030	24.8	38.1
TOTAL			4,541	38.1	

**Wind**

Level	Wind Pressure (lb/ft <sup>2</sup> ) $P_x$	Area (ft <sup>2</sup> ) $a_x$	Lateral Force (kips) $H_x$	Level Shear (kips) $\Sigma F_x$
2	19.4	300	5.8	5.8
1	37.0	1,080	40.0	45.8





**EXAMPLE C3. LOAD COMBINATIONS**

**Lateral Forces Parallel to Long Direction**

**Seismic**

Level	Height (ft) $h_x$	Level Weight (kips) $w_x$	$(w_x)(h_x)$	Lateral Force (kips) $F_x$	Level Shear (kips) $\Sigma F_x$
2	18	83.97	1,511	13.3	13.3
1	10	303.03	3,030	24.8	38.1
TOTAL			4,541	38.1	

**Wind**

Level	Wind Pressure (lb/ft <sup>2</sup> ) $P_x$	Area(ft <sup>2</sup> ) $a_x$	Lateral Force (kips) $H_x$	Level Shear (kips) $\Sigma F_x$
2	32.6	75	2.4	2.4
1	32.6	540	17.6	20.0

**Given:**

**Per original Sample Calculation Statement:**

- Solutions to above Example C1 and C2
- Field investigation information and additional information on the site

**Find:**

1. If the structure can resist sliding using the most appropriate load combination allowable stress design (ASD)
2. If the structure can resist overturning
3. If the structure can resist uplift and buoyancy forces

**Solution for #1:** Check if the structure can resist sliding as follows:

First, the most appropriate load combination for sliding must be found using ASCE 7-10 Section 2.4.1 for ASD, the load combinations are:

1.  $D$
2.  $D + L$
3.  $D + (L_r \text{ or } S \text{ or } R)$
4.  $D + 0.75L + 0.75(L_r \text{ or } S \text{ or } R)$
5.  $D + (0.6W + 0.7E)$
- 6a.  $D + 0.75L + 0.75(0.6W) + 0.75(L_r \text{ or } S \text{ or } R)$
- 6b.  $D + 0.75L + 0.75(0.7E) + 0.75S$
7.  $0.6D + 0.6W$
8.  $0.6D + 0.7E$

**EXAMPLE C3. LOAD COMBINATIONS** (continued)

When a structure is located in a flood zone, the following load combinations should be considered in addition to the basic combinations on Section 2.4.1 of ASCE 7-10:

- In Zone V or A Coastal Zone –  $1.5 F_a$  should be added to load combination 5, 6, and 7 and  $E$  should be set equal to zero in Nos. 5 and 6
- In non-Coastal A Zones –  $0.75 F_a$  should be added to load combination 5, 6, and 7 and  $E$  should be set equal to zero in Nos. 5 and 6

Each possible building failure mode (sliding, overturning, uplift, buoyancy) must be investigated using the most restrictive load combination.

- Controlling condition for sliding: The sum of the forces in the horizontal direction must be LESS than the sliding resistance provided by the soil in order for building to not slide. By inspection, load combination 7 is most restrictive sliding condition because dead load is reduced and flood and wind loads are included for the direction parallel to the ridge. By inspection, load combination 7 is also the most restrictive load combination equation for the direction perpendicular to the ridge, even though no flood load is involved in this direction.
- Weight of the structure used in sliding and overturning calculations must incorporate the use of flood vents. The buoyancy force for the slab and 5 ft of wall must be subtracted from the total weight of the structure:

$$D = 350 \text{ kips} + (0.33 \text{ ft})(1,800 \text{ ft}^2)(-62.4 \text{ lb/ft}^3) + \left(\frac{8}{12} \text{ ft}\right)(5 \text{ ft})(180 \text{ ft})(-62.4 \text{ lb/ft}^3) = 275 \text{ kips}$$

**Parallel to ridge direction:** The coefficient of soil friction is 0.3. Using load combination 7:

$$0.6W + 0.75F_a < 0.6D$$

$$0.6(20.0 \text{ kips}) + 0.75(6.5 \text{ kips} + 2.2 \text{ kips}) = 18.5 \text{ kips for the sliding force}$$

$$0.6(D)(0.3) = (0.6)(275 \text{ kips})(0.3) = 50 \text{ kips for the sliding resistance providing by the soil}$$

19 kips < 50 kips OK in parallel to ridge direction

**Perpendicular to ridge direction:** The coefficient of soil friction is 0.3. Using load combination 7:

$0.6W + 0.75F_a < 0.6D$  where  $F_a = 0$  (flow and flood-borne debris directions are parallel to this direction) and using the coefficient of soil friction 0.3

$$0.6W < 0.6(D)(0.3)$$

$$0.6(45.8 \text{ kips}) = 27.5 \text{ kips for the sliding force}$$

$$0.6(D)(0.3) = (0.6)(275 \text{ kips})(0.3) = 50 \text{ kips for the sliding resistance providing by the soil}$$

27 kips < 50 kips OK in perpendicular to ridge direction

**Therefore, the structure can resist sliding.**

**Solution for #2:** Check if the structure can resist overturning as follows:

- Controlling condition for overturning: The moments caused by the lateral forces must be less than the counter-moment provided by the building weight.

**EXAMPLE C3. LOAD COMBINATIONS** (concluded)

The most likely overturning direction is along the short dimension of the building caused by seismic forces. The ASD factor for the seismic force is 0.7 and the ASD factor for the dead weight of the building is 0.6 per load combination 8.

$$\sum M_{pivot} < 0 \text{ for building to resist overturning}$$

Summing the moments about the pivot point:

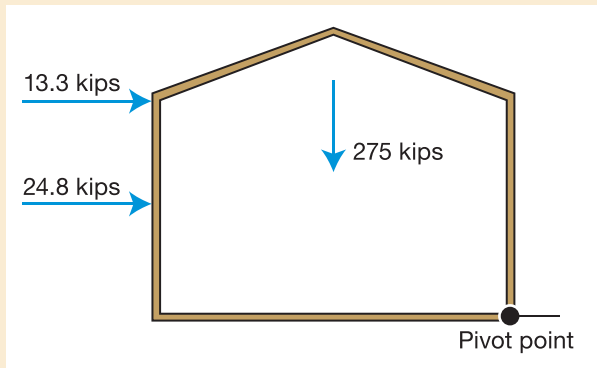

$$\sum M_{pivot} = 0.7(13.3 \text{ kips})(18 \text{ ft}) + 0.7(24.8 \text{ kips})(10 \text{ ft}) - 0.6(275 \text{ kips})(15 \text{ ft}) = -2134 \text{ kips-ft}$$

OK, building weight keeps building from overturning.

**Therefore, the structure can resist overturning.**

**Solution for #3:** Check if the structure can resist uplift and buoyancy forces as follows:

- Controlling condition for uplift and buoyancy: The dead weight of the building must resist the uplift forces imposed by wind and buoyancy on the building. The sum of the forces in the vertical direction must be greater than the buoyancy force in order for the building to stay in the ground. load combination 7 is most conservative. Buoyancy factored as flood load.

$$0.6D + 0.6W + 0.75F_b < 0 \text{ to resist uplift and buoyancy.}$$

**Per Example C1, the elevated structure is incapable of resisting buoyancy forces and flood openings are required.**

*NOTE: For this example analysis, the existing structural components were assumed to be adequate for the loading conditions. However, the designer should check the existing truss-to-wall-connections, plywood roof diaphragm, upper level walls, and floor diaphragm for their ability to resist increased loadings.*



### EXAMPLE C4. CHECK OF EXISTING FOUNDATION DESIGN

#### Given:

Per original Sample Calculation Statement:

- Solutions to above Examples C1, C2, and C3
- Field investigation information and additional information on the site

#### Find:

1. Adequacy of existing foundation design

**Solution for #1:** The adequacy of the existing foundation design can be determined as follows:

- All of the loads on the foundation must be calculated and tabulated using ASCE 7-10. Calculate loads along 60-foot exterior load bearing walls for highest footing loading condition.

$$\text{Snow load} = S = (20 \text{ lb/ft}^2)(1 \text{ ft})(15 \text{ ft} + 2 \text{ ft}_{\text{Overhang}}) = 340 \text{ lb/lf}$$

$$\text{First flood live load} = L = (40 \text{ lb/ft}^2)(1 \text{ ft})(15 \text{ ft} / 2) = 300 \text{ lb/lf}$$

Dead loads:

#### Roof:

$$\text{Shingles: } (15.81 \text{ ft} + 2 \text{ ft})(2 \text{ lb/ft}^2)(1 \text{ ft}) = 35.6 \text{ lb/lf}$$

$$\text{Felt: } (15.81 \text{ ft} + 2 \text{ ft})(0.7 \text{ lb/ft}^2)(1 \text{ ft}) = 12.5 \text{ lb/lf}$$

$$\text{Plywood: } (15.81 \text{ ft} + 2 \text{ ft})(1.5 \text{ lb/ft}^2)(1 \text{ ft}) = 26.7 \text{ lb/lf}$$

$$\text{Truss: } (15 \text{ ft} + 2 \text{ ft} \left( \frac{15 \text{ ft}}{15.81 \text{ ft}} \right))(5 \text{ lb/ft}^2)(1 \text{ ft}) = 84.5 \text{ lb/lf}$$

$$\text{Total} = 35.6 \text{ lb/lf} + 12.5 \text{ lb/lf} + 26.7 \text{ lb/lf} + 84.5 \text{ lb/lf} = 159.3 \text{ lb/lf}$$

#### Ceiling:

$$\text{Insulation: } (15 \text{ ft})(1 \text{ ft})(8 \text{ lb/ft}^2) = 120 \text{ lb/lf}$$

$$\text{Plywood: } (15 \text{ ft})(1 \text{ ft})(1.5 \text{ lb/ft}^2) = 22.5 \text{ lb/lf}$$

$$\text{Plaster: } (15 \text{ ft})(1 \text{ ft})(10 \text{ lb/ft}^2) = 150 \text{ lb/lf}$$

$$\text{Miscellaneous: } (15 \text{ ft})(1 \text{ ft})(2 \text{ lb/ft}^2) = 30 \text{ lb/lf}$$

$$\text{Wall (exterior): } (4 \text{ ft})(1 \text{ ft})(18 \text{ lb/ft}^2) = 72 \text{ lb/lf}$$

$$\text{Wall (interior): } \left( \frac{15 \text{ ft}}{2} \right)(1 \text{ ft})(20 \text{ lb/ft}^2) = 150 \text{ lb/lf}$$

$$\text{Total} = 120 \text{ lb/lf} + 22.5 \text{ lb/lf} + 150 \text{ lb/lf} + 30 \text{ lb/lf} + 72 \text{ lb/lf} + 150 \text{ lb/lf} = 544.5 \text{ lb/lf}$$

#### First Floor:

$$\text{Flooring: } \left( \frac{15 \text{ ft}}{2} \right)(1 \text{ ft})(4 \text{ lb/ft}^2) = 30 \text{ lb/lf}$$

**EXAMPLE C4. CHECK OF EXISTING FOUNDATION DESIGN (concluded)**

$$\text{Subfloor: } \left(\frac{15 \text{ ft}}{2}\right)(1 \text{ ft})(3 \text{ lb/ft}^2) = 22.5 \text{ lb/lf}$$

$$\text{Joists: } \left(\frac{15 \text{ ft}}{2}\right)(1 \text{ ft})(4 \text{ lb/ft}^2) = 30 \text{ lb/lf}$$

$$\text{Insulation: } \left(\frac{15 \text{ ft}}{2}\right)(1 \text{ ft})(5 \text{ lb/ft}^2) = 37.5 \text{ lb/lf}$$

$$\text{Miscellaneous: } \left(\frac{15 \text{ ft}}{2}\right)(1 \text{ ft})(3 \text{ lb/ft}^2) = 22.5 \text{ lb/lf}$$

$$\text{Ceiling: } \left(\frac{15 \text{ ft}}{2}\right)(1 \text{ ft})(2.5 \text{ lb/ft}^2) = 18.8 \text{ lb/lf}$$

$$\text{Wall (exterior): } (4 \text{ ft})(1 \text{ ft})(18 \text{ lb/ft}^2) = 72 \text{ lb/lf}$$

$$\text{Footing: } (2 \text{ ft})(1 \text{ ft})(150 \text{ lb/ft}^3) = 300 \text{ lb/lf}$$

$$\text{Wall (interior): } \left(\frac{15 \text{ ft}}{2}\right)(1 \text{ ft})(20 \text{ lb/ft}^2) = 150 \text{ lb/lf}$$

$$\text{New lower level wall: } (10 \text{ ft})(1 \text{ ft})(46 \text{ lb/ft}^2) = 460 \text{ lb/lf}$$

$$\text{Total} = 30 \text{ lb/lf} + 22.5 \text{ lb/lf} + 30 \text{ lb/lf} + 37.5 \text{ lb/lf} + 22.5 \text{ lb/lf} + 18.8 \text{ lb/lf} + 72 \text{ lb/lf} + 300 \text{ lb/lf} + 150 \text{ lb/lf} + 460 \text{ lb/lf} = 1,143.3 \text{ lb/lf}$$

$$\text{Total}_{DL} = 159.3 \text{ lb/lf} + 544.5 \text{ lb/lf} + 1,143.3 \text{ lb/lf} = 1,847.1 \text{ lb/lf}$$

*NOTE: A 20 lb/ft<sup>2</sup> partition load is applied here; this approach is conservative due to the amount of interior walls in this building.*

From our field investigation it was determined that an allowable bearing pressure of 2,000 lb/ft<sup>2</sup> was acceptable.

- The total load on the foundation must be determined

Total load on foundation:

Most restrictive load combination is Eq.6a.

$$TL = D + 0.75L + 0.75(0.6W) + 0.75(L_r \text{ or } S \text{ or } R)$$

$$TL_{\text{foundation}} = 1,847.1 \text{ lb/lf} + 0.75(300 \text{ lb/lf}) + 0.75(340 \text{ lb/lf}) = 2,327 \text{ lb/lf}$$

- The total load on the foundation must be compared with the capacity of the existing foundation to determine adequacy

The existing foundation is 2 ft wide; thus, the bearing pressure for total loads is

$$\left[\frac{2,327 \text{ lb/lf}}{2 \text{ ft}}\right] = 1,164 \text{ lb/ft}^2 < 2,000 \text{ lb/ft}^2 \text{ Allowable, OK.}$$

**Therefore the existing foundation design is adequate.**



### EXAMPLE C5. NEW FOUNDATION WALL DESIGN

#### Given:

Per original Sample Calculation Statement:

- Solutions to above Examples C1, C2, C3, and C4
- Assume seismic load condition controls design
- Field investigation information and additional information on-site as noted in previous sections
- Assume #4 reinforcing bars at 48 in. o.c. in solid grouted cores
- $G = 0.4E$  where  $E$  = modulus of elasticity per American Concrete Institute (ACI) 530-08 Section 1.8.2.2
- Assume compressive strength of masonry,  $f'_m = 2,000 \text{ lb/in.}^2$
- Type M or S mortar per ACI 530-08 Section 1.8.2.2  $E_m = 900 f'_m = 900 (2,000) = 1.8 \times 10^6 \text{ lb/in.}^2$
- With #4 @ 48 in. o.c. the equivalent solid thickness is 4.6 in. = 0.38 ft
- $M = 120 \text{ kips-ft}$  from Example C2 (maximum moment split in half due to 2 walls)
- $V = 19.2 \text{ kips}$  from Example C2 (maximum shear split in half due to 2 walls)

#### Find:

1. Design the foundation wall and connection to the footing
2. Design top of wall connection. (Checking anchor bolts for pullout from masonry)

**Solution for #1:** To design the foundation wall connection to the footing:

New Wall Design:

- Minimum wall reinforcement is #4 @ 48 in.  $A_s = 0.20/48 \text{ in.}$
- Next determine  $V_m$  (shear strength provided by masonry) per ACI 530-08 Equation 3-22
- Moment is calculated from Seismic Lateral Forces. Refer to the figure below for indicated forces with associated moment arms.

$$V_m = \left[ 4.0 - 1.75 \left( \frac{M}{Vd} \right) \right] A_n \sqrt{f'_m} + 0.25P$$

$$M = \left( \frac{24.8 \text{ kips}}{2} \right) (10 \text{ ft}) + \left( \frac{13.3 \text{ kips}}{2} \right) (18 \text{ ft}) = 243.7 \text{ kips-ft} = 2,924,000 \text{ in.} \cdot \text{lb}$$

$$V = 19.1 \text{ kips}$$

**EXAMPLE C5. NEW FOUNDATION WALL DESIGN** (continued)

$$d = (30 \text{ ft})(12) = 360 \text{ in.}$$

$$A_n = 120 \text{ in.}^2$$

$$f'_m = 2,000 \text{ lb/in.}^2$$

$$P = (189 \text{ lb/ft})(30 \text{ ft}) = 5,670 \text{ lbs} = 5.67 \text{ kips}$$

Where P is equal to the average weight of the 30 ft long framed wall with gable end wall above. So,

$$V_m = \left[ 4.0 - 1.75 \left( \frac{2,924 \text{ kips-in.}}{(19.1 \text{ kips})(360 \text{ in.})} \right) \right] (120 \text{ in.}^2) \sqrt{2,000 \text{ lb/in.}^2} + 0.25 (5,670 \text{ lbs})$$

$$= (17,473 + 1,418) \text{ lbs} = 18.9 \text{ kips}$$

- Finding the resulting shear force per ACI-530-08 Equation 3-23:

$$V_s = 0.5 \left( \frac{A_v}{s} \right) f_v d_v = 0.5 \left( \frac{0.20}{48} \right) (60 \text{ kips})(360) = 45 \text{ kips}$$

$$\frac{M}{Vd} = \frac{243.7 \text{ kips-ft}}{(19.1 \text{ kips})(30 \text{ ft})} \leq 1 \text{ which is acceptable}$$

The resulting shear force per ACI 530-08 Equation 2-25 is:

$$F_v = \left[ \frac{1}{3} \left( 4 - \frac{M}{Vd} \right) \right] \sqrt{f'_m} = \left[ \frac{1}{3} (4 - 0.43) \right] \sqrt{2,000} = 53.2 \text{ lb/in.}^2$$

- Determining the nominal shear strength and comparing to the in-plane shear capacity

$$\text{Nominal Shear Strength } V_n = V_m + V_s = 18.9 \text{ kips} + 45 \text{ kips} = 63.9 \text{ kips}$$

63.9 kips > 53.2 kips OK #4 @ 48 in. o.c. in-plane shear

- Investigate long (60 ft) wall for out-of-plane bending because axial load is also supported by this wall. **Neglect impact load in this analysis.**

Treat wall as simple T-beam 4 ft wide and calculate axial pressure per load determined in Example C4. Section Properties ACI 580-08 Section 1.9 and

$$f_a = \frac{(23,000 \text{ lbs})(4)}{(48 \text{ in.})(7.5 \text{ in.})} = 25.6 \text{ lb/in.}^2$$

$$\text{for } \frac{h}{r} \leq 99 \text{ h/r} \leq 99 \text{ h/r} = 120/2.16 = 55.6 < 99$$

$$= \frac{120}{2.16} \leq 99 = 55.6 \leq 99 \text{ OK}$$

where: h = (10)(12) = 120 in.



**EXAMPLE C5. NEW FOUNDATION WALL DESIGN** (continued)

$$r = \sqrt{\frac{t^2}{12}} = \sqrt{\frac{7.5^2}{12}} = 2.16$$

Axial Compressive Strength of Masonry per ACI-530-08 Equation 2-15. Maximum moment determined from Simple Beam Load Combinations #1 and #5 from Part 4 of *Steel Construction Manual, Volume 1* (2nd Edition) using wind and hydrodynamic flood pressures found in Example C2 and shown in the figure below:

$$F_a = \frac{1}{4} f'_m \left[ 1 - \left( \frac{h}{(140)r} \right)^2 \right] = \frac{1}{4} (2,000) \left[ 1 - \left( \frac{120}{(140)(2.16)} \right)^2 \right] = 421 \text{ lb/in.}^2$$

$$M_{max} = \left[ \frac{wl^2}{8} \right] + \frac{\left[ \left( \frac{w_p a}{2l} \right) (2l - a) \right]^2}{2w_p}$$

$$M_{max} = \left[ (4) \frac{(21.3)(10)^2}{8} \right] + \left[ (4) \frac{\left[ \left( \frac{(22.4)(5)}{2(10)} \right) ((2)(10) - 5) \right]^2}{(2)(22.4)} \right] = 1,065 + 630 = 1,695 \text{ ft-lbs}$$

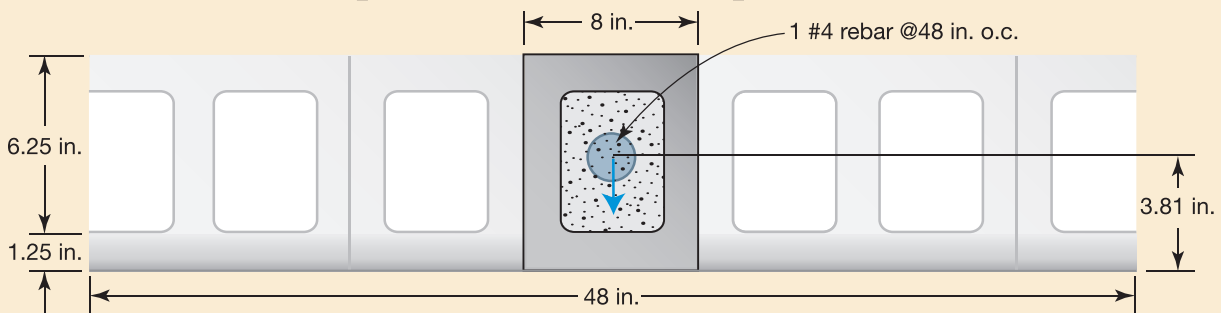

	Area (in. <sup>2</sup> )	$\delta$	$A\delta$	$A\delta^2$	$I$	$(I_x)_i$ (in. <sup>4</sup> )
	(1.25)(48)=60	0.625	37.5	23.44	7.1	31.25
	(8)(6.75)=54	3.81	205.74	783.87	205.03	988.90
<b>Sum</b>	<b>114</b>		<b>243.24</b>			<b>1,020.15</b>

Calculate section modulus for T-beam section of wall

$$y = \frac{243.24}{114} = 2.13 \text{ in.}$$

$$I_{NA1} = I_x - Ay^2 = 1,020.15 \text{ in.}^4 - (114 \text{ in.}^2)(2.13 \text{ in.})^2 = 502.94 \text{ in.}^4$$

$$S = \frac{I_{NA1}}{y} = \frac{502.94}{2.13} = 236.12 \text{ in.}^3$$

**EXAMPLE C5. NEW FOUNDATION WALL DESIGN** (continued)

$$f_b = \frac{M}{S} = \frac{1,695 \text{ ft-lbs}(12 \text{ in. / ft})}{236.12 \text{ in.}^3} = 86 \text{ lb/in.}^2$$

$$F_b = \frac{1}{3} f'_m = 667 \text{ lb/in.}^2$$

- Check combined bending and axial load using interaction equation per ACI 530-08 Equation 2-13. Maximum Shear determined from End Reactions per Simple Beam Load Combinations #1 and #5 from Part 4 of *Steel Construction Manual, Volume 1* (Second Edition) using the wind and hydrodynamic flood pressures found in Example C2. Masonry shear stress ( $f_v$ ) per ACI 530-08 Equation 2-23 and Equation 2-24:

$$\frac{f_a}{F_a} + \frac{f_b}{F_b} \leq 1$$

$$\frac{25.6}{421} + \frac{86}{667} \leq 1 \text{ OK}$$

$$R_{Top} = (4) \left( \frac{(21.3)(10)}{2} + \frac{(22.4)(5)^2}{(2)(10)} \right) = 538 \text{ lbs}$$

$$R_{Bottom} = (4) \left( \frac{(21.3)(10)}{2} + \frac{(22.4)(5)}{(2)(10)} [(2)(5)] \right) = 762 \text{ lbs}$$

$$f_{v\_WallBase} = \frac{V}{bd} = \frac{762}{(7.5)(12)} = 8.5 \text{ lb/in.}^2$$

$$F_v = 50 \text{ lb/in.}^2 > f_v \text{ OK}$$

- Reaction  $R_{Top}$  must be resisted by attachment of floor diaphragm to wall by bolts and wood sill plate.
- Investigate pure bending of wall with maximum moment as determined at beginning of Section C5 and Section Properties per ACI 580-08 Section 1.9.

$M = kbd^2$  where  $M = 1,695 \text{ ft-lbs}$  or  $20,340 \text{ in.-lbs}$ ,  $b = 48 \text{ in.}$ ,  $d = 3.81 \text{ in.}$

$$k = \rho f_s j = \left( \frac{A_s}{bd} \right) f_s j \text{ and } k = \frac{n}{n+r} \text{ where } n = \frac{E_s}{E_m} \text{ and } r = \frac{f_s}{f_m}$$

$$r = \frac{24,000}{2,000} = 12$$

$$k = \frac{16.1}{(16.1+12)} = 0.573$$

$$j = 1 - \frac{k}{3} = 1 - \frac{0.573}{3} = 0.809$$

**EXAMPLE C5. NEW FOUNDATION WALL DESIGN** (continued)

So, the required  $A_s$  for  $M = 1,695$  ft-lb and 48 in. wide T-beam is:

$$A_{s\_required} = \left( \frac{(k)(b)(d)}{f_s j} \right) = \left( \frac{29.2(48)(3.81)}{(24,000)(0.809)} \right) = 0.275 \text{ in.}^2 \text{ N.G., -1 -\#4 BAR} = 0.20 \text{ in.}^2$$

**Solution: Increase reinforcement to 5/8-in. diameter with  $A_s = 0.307 \text{ in.}^2 > 0.275 \text{ in.}^2$**

0.31 in.<sup>2</sup> (1 -#5) OK

**Therefore, use 1-#5 @ 48 in. o.c. to resist bending out-of-plane.**

- Bolt Design

$$\text{Shear at top of wall} = \frac{(538 / 2) \text{ lbs}}{4 \text{ ft}} = 67 \text{ lb/ft}$$

Check shear capacity of 0.5 in.  $\phi$  A307 A.B. in Southern Pine #2 sill plate. Use National Design Specification for Wood (2005), Table 11E. Try sill plate 2 in. x 6 in. so side member = 1-1/2 in., main member = 3 in., shear perpendicular to grain = 410 lbs. Modify value with adjustment factors for connections.

$$\text{So } Z' = Z C_d C_m C_t C_g C_A = (410)(1.29)(1.0)(1.0)(1.0)(1.0) = 529 \text{ lbs}$$

And,

$$\text{Bolt spacing} = \frac{529 \text{ bs}}{67 \text{ lbs/ft}} = 7.9 \text{ ft} = 95 \text{ in.}, \text{ use } 72 \text{ in. max. as required by IRC 2012 Section R403.1.6}$$

$$\text{Edge distance of bolt } 4D = 4(0.5) = 2 \text{ in.}$$

Check bending of sill plate with bolts @ 6 ft o.c.

$$M = \frac{67 \text{ lb/ft}(6 \text{ ft})^2}{8} = 302 \text{ ft-lb}$$

$$S_{2 \times 6} = 7.56 \text{ in.}^3$$

$$f_b = \frac{M}{S} = \frac{302 \text{ ft-lb}(12) \text{ in./ft}}{7.56 \text{ in.}^3} = 479 \text{ lb/in.}^2$$

$$F_b \text{ for Southern Pine \#2} = 1,500 \text{ lb/in.}^2, f_b < F_b \text{ OK}$$

$$\text{Check pullout of A.B. Uplift Force} = \frac{(13.3 \text{ kips})(9 \text{ ft})}{(60 \text{ ft})(30 \text{ ft})} = 67 \text{ lb/ft}$$

For anchors spaced 6 ft o.c., uplift force = 402 lb/bolt

**Therefore, an 8 in. CMU wall with #5 @ 48 in. o.c. centered on grouted cell - 2,000 lb/in.<sup>2</sup> masonry ( $f'_m$ ) is acceptable.**

**EXAMPLE C5. NEW FOUNDATION WALL DESIGN** (continued)

**Solution for #2:** To design the top of wall connection, one must check anchor bolts for pullout from masonry as follows:

Try ½ in.  $\phi$  A307 anchor bolts @ 6 ft o.c.

Uplift on bolt = 402 lb/bolt

Try ½ in.  $\phi$  A307 anchor bolt, area of bolt,  $A_b = 0.2 \text{ in.}^2$

Edge distance,  $l_{be} = 0.5(7.625 - 0.5) = 3.56 \text{ in.}$

Embedment,  $l_b = 7 \text{ in.}$  Required minimum embedment for reinforced masonry IRC 2012 Section R403.1.6

**Reference:** ACI 530-08 Section 2.1.4 and ACI-530-08 Equation 2-10

$$A_{pt} = \pi l_b^2 = \pi(15)^2 = 707 \text{ in.}^2$$

$$A_{pv} = \frac{1}{2} \pi l_{be}^2 = (0.5)\pi(3.56)^2 = 19.9 \text{ in.}^2$$

Allowable load in tension:

$$B_a = \min(1.25(A_{pt})\sqrt{f'_m}, 0.6A_b f_y)$$

Where:

$A_b$  = Area of Anchor Bolt

$$A_{pt} = \pi l_b^2 = \pi(15)^2 = 707 \text{ in.}^2$$

$f'_m$  = Compressive Strength of Masonry

$f_y$  = Yield Strength of Anchor Bolt

For this anchor bolt pattern,

$$B_a = \min(((1.25)(707)(2,000)^{0.5}), (0.6)(.20)(30,000)) = \min(39,500, 3,600) = 3,600 \text{ lbs} > 402 \text{ lbs OK}$$

Allowable load in shear,

$$B_v = \min(1.25A_{pv}\sqrt{f'_m}, 350((f'_m)A_b)^{0.25}, 2.5A_{pt}\sqrt{f'_m}, .36A_b(f_y))$$

$$B_v = \min(((1.25)(19.9)(2,000)^{0.5}), 350((2,000)(.20))^{0.25}, (2.5)(707)\sqrt{2,000}, (.36)(.20)(30,000))$$

$$B_v = \min(1,100, 1,565, 79,000, 2,160) = 1,110 \text{ lbs} > 269 \text{ lbs OK}$$

**Per ACI 530-08 Section 2.1.4.3.3**, the combined ratio is

$$\frac{b_a}{B_a} + \frac{b_v}{B_v} = \frac{402}{3,600} + \frac{269}{1,100} \leq 1$$

**EXAMPLE C5. NEW FOUNDATION WALL DESIGN (concluded)**

Therefore, a 1/2 in.  $\phi$  A307 anchor bolt with an edge distance,  $l_{be} = 3.56$  in. and embedment,  $l_b = 15$  in. is adequate.

**Sample Bearing Wall Detail**

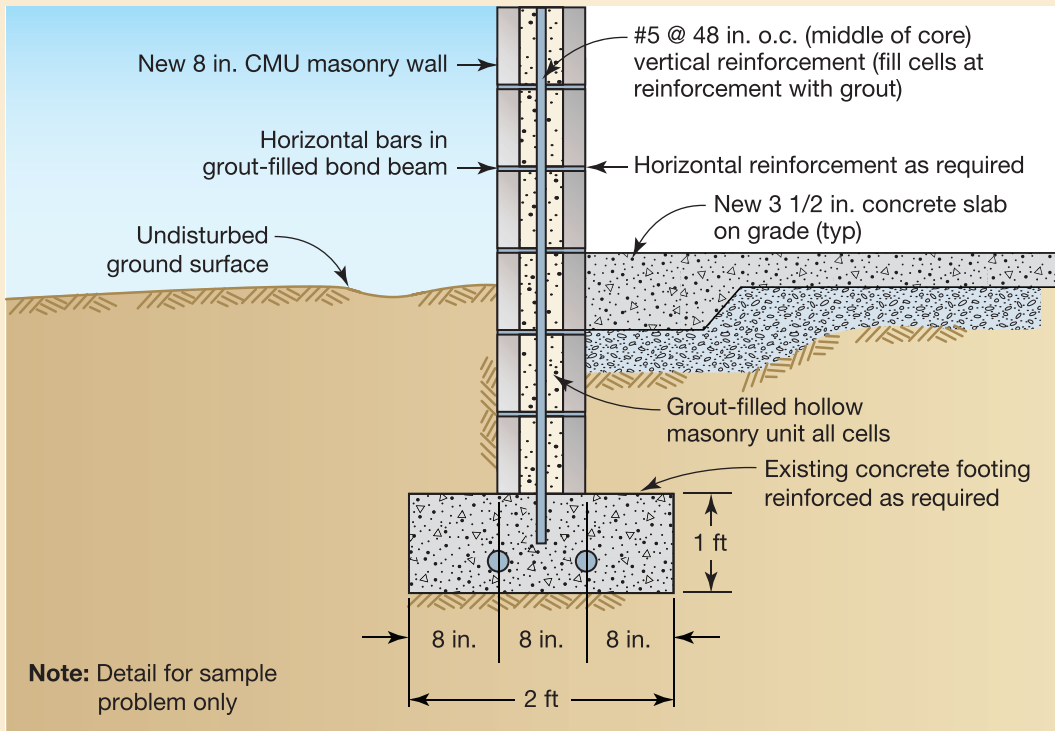



## Dry Floodproofing



### EXAMPLE C6. SAMPLE CALCULATION FOR SUMP PUMP

#### Sump Pump Sizing Calculations

##### Given:

- The drain line is 1.5 in. diameter steel pipe, which is 30 ft long and includes one elbow, one gate valve, and one check valve (based on hydraulic engineering handbooks)
- $Q$  = the flow rate of the sump pump = 20 gal/min
- $V_{fps}$  = Velocity of flow through the pipe in ft/sec
- $A_{pipe}$  = Area of the discharge pipe cross-section in ft
- $Z$  = the elevation difference between the bottom of the sump and the point of discharge, in ft = 10 ft
- $h_{f-pipe}$  = head loss due to pipe friction (for this example use 2.92 ft per 100 ft)
- $h_{f-fittings}$  = head loss through fittings, in ft
- $h_{f-trans}$  = head loss through transitions, in ft
- $K_b$  (elbow) = 0.63
- $K_b$  (gate valve) = 0.15
- $K_e$  (pipe entrance) = 0.5
- $K_o$  (sudden enlargement/outlet) = 1.0
- $g$  = weight of gravity, 32.2 ft/sec
- $TH$  = total head, in ft

##### Find:

1. Velocity converted from gal/min to ft/sec
2. Calculate the losses from pipe fittings and pipe transitions
3. Calculate the losses over the length of pipe
4. Calculate the total dynamic head for the sump discharge

**Solution for #1:** To convert the velocity from gal/min to ft/sec:

$$V_{fps} = \frac{Q}{(7.48 \text{ gal/ft}^3)(60 \text{ sec/min})A_{pipe}}$$

**EXAMPLE C6. SAMPLE CALCULATION FOR SUMP PUMP** (concluded)

$$V_{fps} = \frac{20 \text{ gal/min}}{(7.48 \text{ gal/ft}^3)(60 \text{ sec/min})(3.14) \left( \frac{0.75 \text{ in.}}{12 \text{ in./ft}} \right)^2}$$

$$V_{fps} = \mathbf{3.63 \text{ ft/sec}}$$

**Solution for #2:** The losses from pipe fittings and pipes transitions can be calculated as follows:

$$h_{f-fittings} + h_{f-trans} = (k_b + k_e + k_o) \left( \frac{V_{fps}}{2g} \right)$$

$$h_{f-fittings} + h_{f-trans} = (0.63 + 0.15 + 2.1 + 0.5 + 1.0) \left( \frac{(3.63 \text{ ft/sec})^2}{2(32.2 \text{ ft/sec}^2)} \right)$$

$$h_{f-fittings} + h_{f-trans} = \mathbf{0.25 \text{ ft}}$$

**Solution for #3:** To calculate the losses over the length of the pipe:

$$h_{pipe} = 2.92 \text{ ft} \left( \frac{30 \text{ ft}}{100 \text{ ft}} \right) = \mathbf{0.876 \text{ ft}}$$

**Solution for #4:** To calculate the total dynamic head:

$$TH = Z + h_{f-pipe} + h_{f-fittings} + h_{f-trans}$$

$$TH = \mathbf{11.772 \text{ ft}}$$

*NOTE: Therefore select a pump capable of pumping 20 gal/min at 11.77 ft of total head.*





## Wet Floodproofing



### EXAMPLE C7. NET BUOYANCY FORCE ON A LIQUID PROPANE TANK

#### Given:

- $F_b$  = the net buoyancy force of the tank, in lbs
- $V_t$  = the volume of the tank in gallons = 250 gal
- 0.134 is a factor to convert gal to  $\text{ft}^3$
- $\gamma$  = the specific weight of flood water surrounding the tank (generally  $62.4 \text{ lb/ft}^3$  for fresh water and  $64.1 \text{ lb/ft}^3$  for salt water)
- $FS$  = the factor of safety to be applied to the computation, typically 1.3 for tanks
- $W_t$  = the weight of the tank = 670 lbs (empty – worst case scenario)
- $V_c$  = the volume of concrete required, in  $\text{ft}^3$
- $S_c$  = the effective weight of concrete, typically  $150 \text{ lb/ft}^3$

#### Find:

1. The net buoyancy force of the tank in pounds
2. The volume of concrete required to offset the buoyant force

**Solution for #1:** The net buoyancy force of the liquid propane tank can be found as follows:

$$F_b = [0.134V_t\gamma FS] - W_t$$

$$F_b = 0.134(250 \text{ gal})(62.4 \text{ lbs/ft}^3)(1.3) - 670 \text{ lbs}$$

$$F_b = \mathbf{2,048 \text{ lb}}$$

**Solution for #2:** The volume of concrete required to offset the buoyant force can be determined as follows:

$$V_c = \frac{F_b}{S_c - \gamma}$$

$$V_c = \frac{2,048 \text{ lbs}}{(150 \text{ lb/ft}^3 - 62.4 \text{ lb/ft}^3)}$$

Where:

$$V_c = \mathbf{23.4 \text{ ft}^3}$$

**EXAMPLE C7. NET BUOYANCY FORCE ON A LIQUID PROPANE TANK** (concluded)

*NOTE: To resist this buoyant force, a slab of concrete with a volume,  $V_c$ , is usually strapped to the tank to resist the buoyant load.*



## Floodwalls and Levees

**EXAMPLE C8. FLOODWALL DESIGN****Given:**

Site soil conditions based on clean dense sand:

- $\gamma_{soil}$  (unit weight of soil) = 120 lbs/ft<sup>3</sup>
- $S_a$  (allowable soil bearing capacity) = 2,000 lbs/ft<sup>2</sup>
- $S$  (equivalent fluid pressure of soil) = 78 lbs/ft<sup>3</sup>
- $C_f$  (coefficient of friction) = 0.47
- $k_p$  (passive soil pressure coefficient) = 3.69
- $C_s$  (cohesion) = 0

Local flood conditions:

- Fresh water ( $\gamma_w = 62.4$  lbs/ft<sup>3</sup>)
- Area of potential normal impact loading,  $C_B = 0.2$  (moderate upstream blocking),  $C_{Str} = 0.8$
- Expected flood velocity,  $V$  (ft/sec)

Dimensional information

- $H = 7.0$  ft
- $D_t = 4.0$  ft
- $D = D_b = 5.0$  ft
- $t_{fg} = 1.0$  ft
- $B = 5.0$  ft
- $A_b = 2.5$  ft

**EXAMPLE C8. FLOODWALL DESIGN** (continued)

- $C = 1.5$  ft
- $t_{wall} = 1.0$  ft

**Find:**

1. Design a cantilever floodwall to protect a residence subject to 3 ft of flooding.

**Solution for #1:** To design a cantilever floodwall to protect a residence subject to 3 ft of flooding, follow the eight step process for Floodwall Design in Chapter 5F:

**Step 1:** Assume wall height and footing depth (see Figure 5F-15 in Chapter 5F)

- $H = 7.0$  ft
- $D_t = 4.0$  ft
- $D = D_b = 5.0$  ft
- $t_{ftg} = 1.0$  ft

**Step 2:** Determine dimensions (see Figure 5F-15 in Chapter 5F)

- $B = 5.0$  ft
- $A_b = 2.5$  ft
- $C = 1.5$  ft
- $t_{wall} = 1.0$  ft

Wall and footing to be reinforced concrete having unit weight ( $S_g$ ) of 150 lbs/ft<sup>3</sup>.

**Step 3:** Calculate forces.

Determine Lateral Forces:

$$\text{Equation 4-4: } f_{sta} = \frac{1}{2} \gamma_w H^2 = (0.5)(62.4)(7)^2 = 1,528.8 \text{ lbs/ lf}$$

$$\text{Equation 4-5: } f_{dif} = \frac{1}{2} (S - \gamma_w) D^2 = (0.5)(78 - 62.4)(5)^2 = 195.0 \text{ lbs/ lf}$$

$$\text{Equation 4-7: } dh = \frac{C_d V^2}{2g} = dh = \frac{(1.25)(5)^2}{2(32.2)} = 0.49 \text{ ft}$$

$$\text{Equation 4-8: } f_{dh} = \gamma_w (dh) H = (62.4)(0.49)(7) = 214.0 \text{ lbs/ lf}$$

$$F_n = WVC_D C_B C_{Str} = (1,000)(5)(0.5)(0.2)(0.8) = 400 \text{ lbs/ lf}$$

$$\text{Equation 5F-9: } F_{sta} = f_{sta} + f_{dif} + f_{dh} = 1,528.8 + 195 + 214 = 1,937.8 \text{ lbs/ lf}$$

**EXAMPLE C8. FLOODWALL DESIGN (continued)**

Since  $F_n$  acts only at a single point, we will not include loading into the uniform lateral floodwall loading. Once the floodwall is sized, we will evaluate the wall perpendicular to flow to determine ability to resist the impact loading. If necessary this wall will be redesigned to resist impact loads. This process will avoid overdesigning of the entire floodwall.

$$\begin{aligned} \text{Equation 5F-12: } F_p &= \frac{1}{2} [k_p(\gamma_{soil} - \gamma_w) + \gamma_w] D_t^2 = \\ &0.5 [3.69(120 - 62.4) + (62.4)] (4)^2 = 2,199.6 \text{ lb/ lf} \end{aligned}$$

Determine Vertical Forces:

$$\text{Equation 5F-1: } f_{buoy} = \frac{1}{2} \gamma_w HB = (0.5)(62.4)(7)(5) = 1,092 \text{ lbs/ lf}$$

$$\text{Equation 5F-1: } f_{buoy2} = \frac{1}{2} \gamma_w DtB(0.5)(62.4)(4)(5) = 624 \text{ lbs/ lf}$$

$$\text{Equation 5F-1: } f_{buoy} = f_{buoy1} + f_{buoy2} = 1,092 + 624 = 1,716 \text{ lbs / lf}$$

$$\text{Equation 5F-2: } w_{wall} = (H - t_{fig}) t_{wall} S_g = [7 - 1](1)(150) = 900 \text{ lbs/ lf}$$

$$\text{Equation 5F-3: } w_{fig} = B t_{fig} S_g = (5)(1)(150) = 750 \text{ lbs/ lf}$$

$$\text{Equation 5F-4: } w_{st} = C(D_t - t_{fig})(\gamma_{soil}) = 1.5(4 - 1)(120) = 540 \text{ lbs/ lf}$$

$$\text{Equation 5F-5: } w_{sb} = A_b(D_b - t_{fig})(\gamma_{soil} - \gamma_w) = 2.5(5 - 1)(120 - 62.4) = 576 \text{ lbs/ lf}$$

$$\text{Equation 5F-6: } w_{wb} = A_b(H - t_{fig})(\gamma_w) = 2.5(7 - 1)(62.4) = 936 \text{ lbs/ lf}$$

$$\text{Equation 5F-7: } w_G = w_{wall} + w_{fig} + w_{st} + w_{sb} + w_{wb} = 900 + 750 + 540 + 576 + 936 = 3,702 \text{ lbs/ lf}$$

$$\text{Equation 5F-8: } F_v = w_G - f_{buoy} = 3,072 - 1,702 = 1,986 \text{ lbs/ lf} > 0$$

**Step 4:** Check sliding.

$$\text{Equation 5F-10: } F_{fr} = C_f F_v = 0.47(1,986) = 933.4 \text{ lbs/ lf}$$

$$\text{Equation 5F-11: } F_c = C_s B = 0(5) = 0$$

$$\text{Equation 5F-13: } F_R = F_{fr} + F_c + F_p = 933.4 + 0 + 2,199.6 = 3,133 \text{ lbs/ lf}$$

$$\text{Equation 5F-14: } FS_{(SL)} = \frac{F_R}{F_{sta}} = \frac{(3,133)}{(1,937.8)} = 1.6 > 1.5 \text{ (recommended) OK for sliding}$$

**Step 5:** Check overturning.

**EXAMPLE C8. FLOODWALL DESIGN (continued)**

Equation 5F-15:

$$\begin{aligned}
 M_O &= F_{sta} \left( \frac{H}{3} \right) + f_{dif} \left( \frac{D}{3} \right) + f_{buoy1} \left( \frac{2B}{3} \right) + \left[ f_{dh} \left( \frac{H}{2} \right) \text{ or } F_d \left( H - \frac{D_b}{2} + D_b \right) \right] + F_n H \text{ or } F_s H + f_{buoy2} \left( \frac{B}{3} \right) \\
 &= (1,937.8) \left( \frac{7}{3} \right) + (195) \left( \frac{5}{3} \right) + (1,092) \left( \frac{2(5)}{3} \right) + \left[ (214) \left( \frac{7}{2} \right) \right] + (624) \left( \frac{5}{3} \right) \\
 &= 10,276 \text{ ft-lbs/lf}
 \end{aligned}$$

$$\begin{aligned}
 \text{Equation 5F-16: } M_R &= w_{wall} \left( C + \frac{t_{wall}}{2} \right) + w_{fig} \left( \frac{B}{2} \right) + w_{st} \left( \frac{C}{2} \right) + w_{sb} \left( B - \frac{A_b}{2} \right) + w_{wb} \left( B - \frac{A_b}{2} \right) + F_p \left( \frac{D_t}{3} \right) \\
 &= (900) \left( 1.5 + \frac{1}{2} \right) + (750) \left( \frac{5}{2} \right) + (540) \left( \frac{1.5}{2} \right) + (576) \left( 5 - \frac{2.5}{2} \right) + (936) \left( 5 - \frac{2.5}{2} \right) + (2,199.6) \left( \frac{4}{3} \right) \\
 &= 12,683 \text{ ft-lbs/lf}
 \end{aligned}$$

$$\text{Equation 5F-17: } FS_{(OT)} = \frac{M_R}{M_O} = \frac{(12,683)}{(10,276)} = 1.2 < 1.5 \text{ (recommended) No Good}$$

Try increasing the footing size to overcome the overturning moment. Assume  $B = 7.0$  ft;  $A_b = 4.0$  ft; and  $C = 2.0$  ft. This requires revision of Steps 3 and 4 for which the results are shown below.  $f_{sta}$ ,  $f_{dif}$ ,  $f_{dh}$ ,  $F_{sta}$ ,  $F_p$ ,  $w_{wall}$  will not change. Recompute vertical forces.

$$\text{Equation 5F-1: } f_{buoy1} = \frac{1}{2} \gamma_w H B = (0.5)(62.4)(7)(7) = 1,528.8 \text{ lbs/lf}$$

$$\text{Equation 5F-1: } f_{buoy2} = \frac{1}{2} \gamma_w D_t B = (0.5)(62.4)(4)(7) = 873.6 \text{ lbs/lf}$$

$$\text{Equation 5F-1: } f_{buoy} = f_{buoy1} + f_{buoy2} = 1,528.8 + 873.6 = 2,402.4 \text{ lbs/lf}$$

$$\text{Equation 5F-2: } w_{wall} = (H - t_{fig}) t_{wall} S_g = [7 - 1](1)(150) = 900 \text{ lbs/lf}$$

$$\text{Equation 5F-3: } w_{fig} = B t_{fig} S_g = (7)(1)(150) = 1,050 \text{ lbs/lf}$$

$$\text{Equation 5F-4: } w_{st} = C (D_t - t_{fig}) (\gamma_{soil}) = 2(4 - 1)(120) = 720 \text{ lbs/lf}$$

$$\text{Equation 5F-5: } w_{sb} = A_b (D_b - t_{fig}) (\gamma_{soil} - \gamma_w) = 4(5 - 1)(120 - 62.4) = 921.6 \text{ lbs/lf}$$

$$\text{Equation 5F-6: } w_{wb} = A_b (H - t_{fig}) (\gamma_w) = 4(7 - 1)(62.4) = 1,497.6 \text{ lbs/lf}$$

$$\begin{aligned}
 \text{Equation 5F-7: } w_G &= w_{wall} + w_{fig} + w_{st} + w_{sb} + w_{wb} = \\
 &900 + 1,050 + 720 + 921.6 + 1,497.6 = 5,089.2 \text{ lbs/lf}
 \end{aligned}$$

$$\text{Equation 5F-8: } F_v = w_G - f_{buoy} = 5,089.2 - 2,402.4 = 2,686.8 \text{ lbs/lf} > 0$$

**Recheck Sliding**

$$\text{Equation 5F-10: } F_{fr} = C_f F_v = 0.47(2,686.8) = 1,262.8 \text{ lbs/lf}$$

$$\text{Equation 5F-11: } F_c = C_s B = 0(7) = 0$$

**EXAMPLE C8. FLOODWALL DESIGN (continued)**

$$\text{Equation 5F-13: } F_R = F_{fr} + F_c + F_p = 1,262.8 + 0 + 2,199.6 = 3,462.4 \text{ lbs/lf}$$

$$\text{Equation 5F-14: } FS_{(SL)} = \frac{F_R}{F_{sta}} = \frac{(3,462.4)}{(1,937.8)} = 1.79 > 1.5 \text{ (recommended) OK for sliding}$$

**Recheck Overturning**

Equation 5F-15:

$$\begin{aligned} M_O &= F_{sta} \left( \frac{H}{3} \right) + f_{dif} \left( \frac{D}{3} \right) + f_{buoy1} \left( \frac{2B}{3} \right) + \left[ f_{db} \left( \frac{H}{2} \right) \text{ or } F_d \left( H - \frac{D_b}{2} + D_b \right) \right] + F_n H \text{ or } F_s H + f_{buoy2} \left( \frac{B}{3} \right) \\ &= (1,937.8) \left( \frac{7}{3} \right) + (195) \left( \frac{5}{3} \right) + (1,528.8) \left( \frac{2(7)}{3} \right) + \left[ (214) \left( \frac{7}{2} \right) \right] + (873.6) \left( \frac{7}{3} \right) \\ &= 14,748 \text{ ft-lbs/lf} \end{aligned}$$

$$\begin{aligned} \text{Equation 5F-16: } M_R &= w_{wall} \left( C + \frac{t_{wall}}{2} \right) + w_{fig} \left( \frac{B}{2} \right) + w_{st} \left( \frac{C}{2} \right) + w_{sb} \left( B - \frac{A_b}{2} \right) + w_{wb} \left( B - \frac{A_b}{2} \right) + F_p \left( \frac{D_t}{3} \right) \\ &= (900) \left( (2) + \frac{1}{2} \right) + (1,050) \left( \frac{7}{2} \right) + (720) \left( \frac{2}{2} \right) + (921.6) \left( (7) - \frac{4}{2} \right) + (1,497.6) \left( (7) - \frac{4}{2} \right) + (2,199.6) \left( \frac{4}{3} \right) \\ &= 21,674 \text{ ft-lbs/lf} \end{aligned}$$

$$\text{Equation 5F-17: } FS_{(OT)} = \frac{M_R}{M_O} = \frac{(21,674)}{(14,748)} = 1.5 = 1.5 \text{ (recommended) OK}$$

**Step 6:** Determine eccentricity.

$$\text{Equation 5F-18: } e = \left( \frac{B}{2} \right) - \left( \frac{M_R - M_O}{F_v} \right) = \left( \frac{7}{2} \right) - \left( \frac{(21,674 - 14,748)}{2,686.8} \right) = 0.92 < \frac{7}{6} \text{ OK}$$

**Step 7:** Check soil pressure.

$$\text{Equation 5F-19: } q = \left( \frac{F_v}{B} \right) \left( 1 \pm \left( \frac{6e}{B} \right) \right)$$

$$q_{min} = \left( \frac{2,686.8}{7} \right) \left( 1 - \left( \frac{6(0.88)}{7} \right) \right) = 94.3 \text{ lbs/ft}^2$$

$$q_{max} = \left( \frac{2,686.8}{7} \right) \left( 1 + \left( \frac{6(0.88)}{7} \right) \right) = 673.3 \text{ lbs/ft}^2 < 2,000 \text{ lbs/ft}^2 \text{ OK}$$

**Step 8:** Select reinforcing steel.

For steel in the vertical floodwall section:

$$\text{Equation 5F-20 (note): } M_b = F_{sta} \left( \frac{H}{3} - t_{fig} \right) = (1,937.8) \left( \frac{7}{3} - (1) \right) = 2,583.7 \text{ ft-lbs/lf}$$

$$\text{Equation 5F-20: } A_s = \frac{\left( \frac{M_b}{1,000} \right)}{1.76d_f} = \frac{\left( \frac{2,583.7}{1,000} \right)}{1.76(8.5)} = 0.17 \text{ in.}^2/\text{lf}$$

**EXAMPLE C8. FLOODWALL DESIGN** (concluded)

For top steel in the footing section:

$$\text{Equation 5F-20 (note): } M_b = (w_{sb} + w_{wb}) \left( \frac{A_b}{2} \right) = (921.6 + 1,497.6) \left( \frac{4}{2} \right) = 4,838.4 \text{ ft-lbs/lf}$$

$$\text{Equation 5F-20: } A_s = \frac{\left( \frac{M_b}{1,000} \right)}{1.76d_f} = \frac{\left( \frac{4,838.4}{1,000} \right)}{1.76(8.5)} = 0.32 \text{ in.}^2/\text{lf}$$

For bottom steel in the footing section:

$$\text{Equation 5F-20 (note): } = 673.3 - \left( \frac{1.5}{8} \right) (673.3 - 94.3) = 564.7 \text{ lb/in.}^2$$

$$\text{Equation 5F-20 (note): } M_b = (q + 2q_{max}) \left( \frac{C^2}{6} \right) = [564.7 + 2(673.3)] \left( \frac{(2)^2}{6} \right) = 1,274.2 \text{ ft-lb/lf}$$

$$\text{Equation 5F-20: } A_s = \frac{\left( \frac{M_b}{1,000} \right)}{1.76d_f} = \frac{\left( \frac{1,274.2}{1,000} \right)}{1.76(8.5)} = 0.09 \text{ in.}^2/\text{lf}$$

From American Concrete Institute Reinforced Concrete Design Handbook Table 9a: **Use #4 bars on 14-inch centers in the vertical floodwall section, use #6 bars on 14-inch centers for the top steel in the footing section, and use #3 bars on 14-inch centers for the bottom steel in the footing section for B = 7.0 ft; Ah = 4.0 ft; and C = 2.0 ft.**

*NOTE: Other ACI documents have similar information.*





## APPENDIX D

# Alluvial Fan Flooding

Alluvial fan flooding is a hazard to communities in the mountainous regions of the western United States. Alluvial fan flooding is characterized by a sudden torrent of water capable of carrying rocks, mud, and debris that debouches from the steep valleys and canyons and spreads over the fan surface. The type of detailed flood damage mitigation information available for other flood-prone areas is limited for alluvial fan situations. Fan flood flows are characterized by surging, erosion, scour, channel avulsion, mud and debris flows, and sheet flows on the lower portions of the fan surface. Each fan flood event as well as each fan can exhibit different flood characteristics.

Development over the last several decades has proceeded with little cognizance of the potential for flood hazards. Many fan communities are now preparing flood management and mitigation plans, but existing structures may have to rely on floodproofing measures to reduce flood damage. Fan-wide master plans for zoning and fan-wide mitigation measures are crucial for successful protection of the community as a whole. Where master plans or mitigation schemes are inadequate or nonexistent, floodproofing and retrofitting of residences may provide the only reasonable methods for flood loss reduction.

This appendix includes a description of alluvial fan flooding and associated hazards; an overview of the regulatory framework and building code issues unique to fan areas; and design considerations for retrofitting in alluvial fan flooding areas.

## D.1 Alluvial Fan Flooding Basics

Most alluvial fan floods are caused by high-intensity, short-duration summer thunderstorms. Longer duration rainstorms and spring snowpack melt, volcanically-induced flooding, and failure of water storage facilities can also cause alluvial fan floods. Alluvial fan floods can occur without warning. Both the hydraulic and hydrologic flood characteristics of alluvial fans are highly variable from fan to fan, which may be in different



### NOTE

For more information regarding alluvial fans, see:

FEMA's webpage: [http://www.fema.gov/plan/prevent/floodplain/nfipkeywords/alluvial\\_fan\\_flooding.shtm](http://www.fema.gov/plan/prevent/floodplain/nfipkeywords/alluvial_fan_flooding.shtm)

*Living with the River* (Washington State Department of Ecology, 2007).

FEMA 165, *Alluvial Fans: Hazards and Management* (FEMA, 1989). FEMA 165 provides an overview of alluvial fans and related management issues, and briefly discusses retrofitting of individual residential structures

stages of episodic growth. A geologist, geomorphologist, hydrologist, or hydraulic engineer experienced in alluvial fan technology should be consulted to identify alluvial fan characteristics and the possible response to flooding.

There are three zones that may be identified on the surface of an alluvial fan (Figure D-1). Each zone has unique hydraulic and sediment-transport processes during a flooding event, as well as a unique hazard level. The exact location of each zone on a given fan is dependent on flooding characteristics, but usually can be identified on the fan surface after a recent flood event. These zones are:

**Channelized Zone:** Generally located at and below (downstream of) the fan apex. Flow within this zone is confined to well-defined channels, although channels may split or abruptly change direction. This zone is associated with hazardous flooding conditions related to high flow velocities, boulder and debris impact, and channel scour. If channels are deeply incised, this zone may extend further down the fan.

**Braided Zone:** Downstream of the channelized zone, characterized by flow with an unstable pattern of numerous interlacing shallow channels. Flood hazards in this zone are related to flood inundation and sediment deposition, rather than high flow velocity or debris impact. Large boulder transport is generally absent in this zone.



**TERMINOLOGY:  
ALLUVIAL FAN**

In mountainous regions in the west, floodwater may spread out in a fan shape as it flows from the mouth of a watershed to the valley below. The floodwater erodes the steep slopes of the watershed and deposits sediment in a cone or fan shape over the flatter land. Over time, this process creates a land form known as an alluvial fan.

Figure D-1.  
Alluvial fan  
flooding zones  
and other geologic  
features

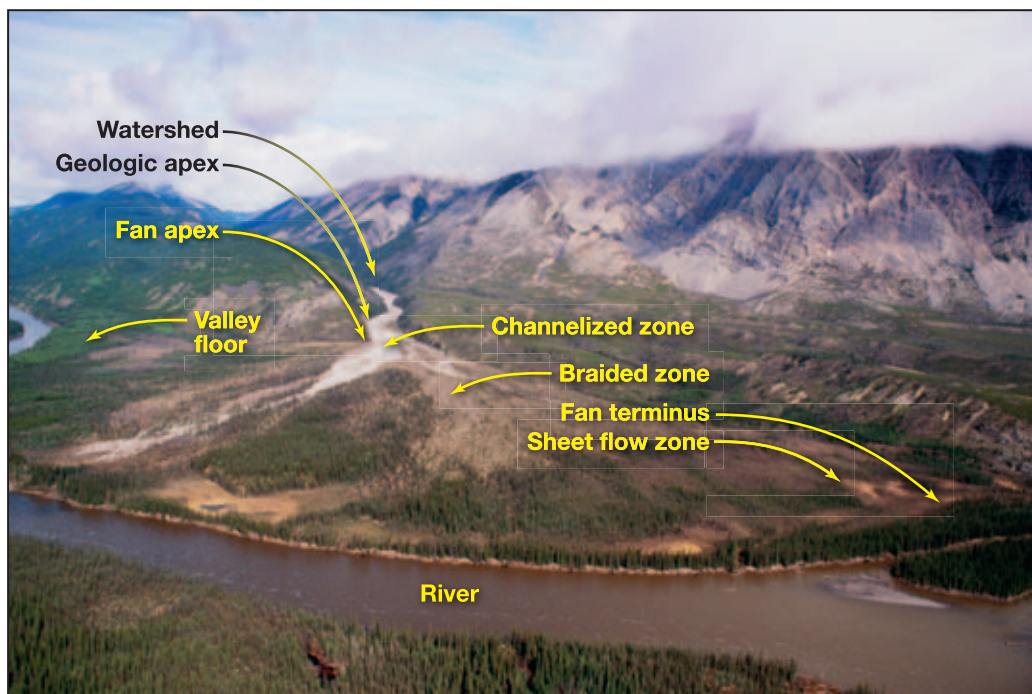

**Sheet Flow Zone:** Downstream of the braided zone characterized by flow depths less than ½ foot (flow depths normally decrease in the downfan direction). Smaller channels may aggrade while other areas are subject to erosion or scour. Flow may continue to spread laterally until sheet flow is predominant. Floods are usually limited to inundation by low velocity floodwater.

Streets and buildings can change the composition of a fan zone by redistributing floodwater over the fan surface. The altered flood response can impact areas on the fan that may have been considered outside the originally delineated flood hazard zone. As a fan is developed, delineation of flood hazards may change.

## D.2 Alluvial Fan Flooding Hazards

While alluvial fans present flood hazards found in riverine flooding such as inundation and differential hydrostatic loading, they are often compounded by high velocities, hyperconcentrated sediment flows, severe erosion, and extensive sediment deposition. Structures on alluvial fans may be susceptible to damage caused by high velocity water; lateral loading that forces structures off foundations or induces wall collapse; water inundation; scour and undermining of buildings; impact of mud, debris, and boulders; sediment burial; and landscape erosion.

Alluvial fan processes and the resultant fan morphology are dependent upon hydrologic conditions of the upstream watershed. Factors contributing to devastating fan flooding include; high intensity rainfall events on sparsely vegetated steep slopes; steep watershed slopes with highly erosive soils or unstable geologic formations; sediment buildup and storage in watershed channels; saturated soil conditions from antecedent rain and snowmelt; recent forest fires, logging, or other soil-destabilizing activities in the watershed; intensity and configuration of development of the fan and failure of flood mitigation measures.

Fan flooding can occur through the continuum of sediment transport processes from clear water flows to hyperconcentrated sediment flows such as mud floods and debris flows.

A **water flood** is the inundation of the fan surface from overbank discharge or rainfall/snowpack runoff. Fan water floods are common in the southwest desert. Water flooding can cause damage by inundating the lowest floor, scouring and undermining structures, displacing buildings from foundations, physically tearing apart structures, or depositing sediment in basements and yards. Sediment loads are less than 20 percent of the total flow and do not significantly affect fluid flow properties.

When the concentration of sediment in the flow reaches 20 to 40 percent by volume, the flow is considered to be “hyperconcentrated” and can be defined as **mud flow**. Mud flows can be destructive to buildings because they are usually associated with high velocity flows. In addition to the property damage for a water flood, mud flows can cause severe property damage related to sediment deposition and result in loss of life. Cleanup costs can be significantly higher for a mud flood than a water flood. Damage results from inundation by mud, impact of mud frontal waves, and high lateral loading, which can result in structure collapse. Mud flows can raft large boulders and debris on their flow surfaces, causing substantial impact damage.



### NOTE

The July 24, 1977, mud flows in Glenwood Springs, Colorado, resulted in approximately \$500,000 (1977 dollars) in damage, most of which involved mud removal.

**Debris flows** are hyperconcentrated flows with a sediment concentration that may be greater than 55 percent by volume. They consist primarily of rolling and tumbling boulders and debris and only a limited amount of fluid for lubrication. Fifty percent or more of the particles in a debris flow are generally larger than sand. The alluvial fans of the Pacific Northwest, Rocky Mountains, and the West Coast ranges can experience severe mud and debris flows whose surges can engulf entire buildings, resulting in structural damage, movement, or complete collapse.

**WARNING**

Debris flows are less likely to occur than water or mud floods, but can cause more damage due to the impact of high velocity boulders or debris waves, which crash through building walls or knock structures off foundations.

**Channel avulsion** is the episodic, and often erratic, shift of a channel's path. Channel avulsion may be initiated by sediment deposition that can fill or block the channel, forcing the flow to create a new path, or by bank erosion, through which the flow will be diverted. The new flow path will often follow a steeper course. Structures located in the path of a newly forming channel are often undermined and destroyed.

Frontal waves, surging, and hydrostatic pressure are significant flood hazards associated with alluvial fan flooding. Mud flows and debris flows can have frontal waves up to 15 feet high. Surging increases the flood hazard by subjecting structures to significantly higher flow depths and velocities. Surges have been observed at 8 feet high, and more than double the flow depth. Once the mud or debris flow has ceased, the resulting sediment deposition against a building can exert large lateral pressures that may be nonuniform across the face of the wall. In addition to the impact and differential hydrodynamic loading related to mud flows, the weight of the deposited mud can cause structural damage to buildings designed to withstand predicted hydrostatic and hydrodynamic loads. Often large boulders, trees, or other debris will come to rest against the upfan side of a building, contributing to the nonuniform lateral load on a wall.

**WARNING**

The depth of flooding shown on FIRMs for alluvial fans should be considered an estimate for the entire fan area, not an absolute value. Alluvial fan flood depths may vary from the given flood depth by several feet, depending upon local conditions. Site-specific analysis should be undertaken to accurately determine flood depth for a retrofitting project.

### D.3 Regulatory Framework and Building Code Issues for Alluvial Fans

Within the regulatory context of the National Flood Insurance Program (NFIP) and building codes, alluvial fan flooding poses special problems for individuals and agencies trying to interpret guidelines prepared specifically for riverine flooding conditions.

Although FEMA recognizes alluvial fan flooding hazards, guidelines do not specifically address mud and debris flow hazards or sheet flow inundation on urbanized alluvial fans. Unmapped urbanized fans are not subject to FEMA/NFIP insurance or mitigation criteria. In response to increased exposure to fan flooding, some communities have undertaken flood hazard delineation and have instituted local ordinances and regulations for fan development. In most states, there are no guidelines or regulations governing hazard delineation, zoning regulations, or mitigation for new construction.



In communities that have not adopted specific alluvial fan flood hazard regulations and ordinances, it is left to the developers and homeowners to mitigate flood hazards or implement floodproofing. Progressive communities have conducted studies to more effectively determine the extent of flood hazards. Once the potential for the flood hazard is understood, a permitting and review body can draft ordinances and regulations governing development on alluvial fans. Residential retrofitting methods should be compatible with comprehensive alluvial fan flood hazard mitigation and master drainage plans. Integration of the retrofitting method with existing drainage and mitigation measures (such as streets designed as conveyance channels) can reduce flood damage in densely populated neighborhoods. Floodproofing should direct flows into desirable paths such as streets or dedicated flow-through areas, and should not encroach on setback distances. Regulations may require setbacks from existing channels.

Every fan has areas of extreme flood hazards where hazard avoidance is essential. If “no build” zones have been designated, building permits should be denied within these zones (often in the channelized and braided zone). The idea that deflection of floodwater can be caused by structures should be considered. Local ordinances may specify that the proposed retrofitting must be able to pass the flood through the property or development without increased damage to other structures. NFIP regulations concerning conveyance around a new structure in Zone AO may also be applied to retrofitting situations.

**NOTE**

A well-integrated approach to floodproofing and fan flood mitigation can reduce flood losses and possibly lower flood insurance costs where the measures are approved by FEMA.

In addition to the minimum requirements of the NFIP, the International Residential Code (IRC) addresses building requirements for structures located in riverine flood hazard areas designated by approved flood insurance maps or the local floodplain management ordinance. Under the IRC, building design is required to withstand the forces associated with the base flood level of the 1-percent-annual-chance flood event. The IRC requires the use of well-established engineering principles in the design of structural members to resist flotation, stress increases, overturning, collapse, or permanent lateral movement due to flood-induced loads (hydrostatic, hydrodynamic, and impact loads).

Finally, structural flood mitigation and floodproofing measures should also be integrated into the community master emergency plan to avoid impeding emergency services during a flood event. The diversion of flow by a floodwall into a designated emergency route may eliminate access to areas of the fan by emergency equipment.

## D.4 Design Considerations for Retrofitting in Alluvial Fan Flooding Areas

Residential retrofitting measures may include relocation, elevation, floodwalls and levees, building reinforcement, dry floodproofing, site grading, and landscaping. Retrofitting measures can be permanent, contingent, or emergency. In general, fan flooding occurs with very little warning, limiting the effectiveness of contingency or emergency measures that require human intervention.

**WARNING**

Residential retrofitting measures should be compatible with the master plan components. Retrofitting can negatively impact the downfan flood hazards when not considered in the context of a master drainage plan.

### **D.4.1 Relocation**

When considering relocation as a retrofit option, master drainage plans, hazard zone delineation, building codes, public purchase of land, open space dedication, and land trades are all considerations. Although relocation is a significant undertaking, it may be economically feasible considering the potential threat to lives and property on the upper reaches of the fan.

### **D.4.2 Elevation**

When considering elevation as a mitigation retrofit, consider that the NFIP and IRC require that new or substantially improved/damaged structures must be elevated at least to the flow depth indicated on the Flood Insurance Rate Map (FIRM), or at least 2 feet if no depth is given. Local regulations may also require additional freeboard. In areas of potential mud, debris, and high-velocity flows, additional freeboard should be considered.

Elevation on posts or piles permits floodwater to pass underneath the structure, causing little obstruction to flow. A properly designed pile will carry all inherent structural loads and lateral loads (hydrodynamic and impact) expected during the design flood. An additional important design consideration for piles is potential scour. Spacing of posts and piles should be relatively wide to minimize flow constriction or the collection of debris found in the watershed or on the fan. The failure of supporting members could potentially cause more damage than inundation of a non-elevated structure. In contrast, elevation on fill may impose a significant obstruction to the flood path; therefore, constriction and diversion of flow onto adjacent properties is a concern. Application and compaction of fill should follow standard engineering practices. The toe of the fill slope must be protected from scour; this slope protection should be extended at least 2 feet below grade. The fill slope above grade should be protected by rock rip-rap or vegetation to at least the base flood level.

### **D.4.3 Floodwalls and Levees**

Floodwalls and levees may be considered on the upfan portion of a building to protect it from the forces of moving water and inundation. The height of floodwalls should be based on a specified design maximum flow depth plus freeboard. The estimated freeboard should include velocity head, wave height, potential flow runoff, potential for sediment deposition against the wall, and surging. Design height for floodwalls and levees should be limited to 3 to 4 feet. Floodwalls should be constructed below grade to provide protection from scour. Stability design should take into account material removed by scour. Frequently utilized on riverine floodplains, levees may require some modification when applied on alluvial fans. On alluvial fans, levees can divert flow around a subdivision or residence, or they may provide protection along a natural or engineered channel through a developed area. Levees should be designed to protect against scour and levee slope erosion.

On steep alluvial fan slopes, the complete enclosure of a structure by a floodwall and levee is not usually necessary, and the downfan side of the property does not require a floodwall. Closures should not be included in the protective structure because failure of the closure may cause complete failure of the floodwall or levee. In some instances, floodwalls have been used primarily for protection against mud and debris flows, without restricting seepage but ensuring structural stability.



The U.S. Army Corps of Engineers (draft report, undated) recommends avoiding this retrofitting alternative for mud and debris flows where the overtopping or failure of levees and floodwalls can cause catastrophic damage in excess of the damage that would have occurred in an area devoid of protection. Mud and debris flow deposition on the upfan side of the wall or levee may increase the potential for overtopping or runoff. The use of floodwalls and levees is most appropriate in fan flood hazard zones characterized by low and moderate velocity flows or mud flows in low density development.

#### D.4.4 Building Reinforcement

Structures located in areas subject to hydrodynamic and impact forces from water, mud, and debris flows can be protected against damage and collapse through structural reinforcement of upfan walls. Reinforcement may include the addition of structural supporting members or an exterior facade, or the removal and replacement of existing walls. In conjunction with the reinforcement of upfan walls, removal of openings in the upfan wall should be investigated. If these openings are removed, they may need to be replaced with openings on other walls. Weak points in the bearing wall, such as windows, doors, and utility connections, may leak or fail under flooding conditions and should be reinforced and floodproofed or eliminated. Reinforcement of upfan walls should be designed for impact pressures and hydrodynamic loading related to mud and debris flows.

#### D.4.5 Dry Floodproofing

Dry floodproofing is appropriate for shallow flooding zones where the base flood elevation is not determined. This technique can be used for brick veneer and masonry structures where floor slabs are rigidly connected to walls.

External dry floodproofing consists of an impervious layered sheet material such as tar or asphalt bitumen applied to the exterior of the building. Excavation around the foundation may be required to externally floodproof building material below the ground surface subject to soil saturation during the flooding event. Membrane materials should be designed to resist all expected flooding conditions including scour, abrasion, impact, and hydrostatic and hydrodynamic pressures. On alluvial fans subject to mud and debris flows, the external membrane cannot be exposed to the flow. External membranes may not be required on the downfan side of a building.



#### WARNING

Dry floodproofing is not allowed by FEMA for new or substantially improved or damaged residential structures located in a Special Flood Hazard Area.

#### D.4.6 Other Techniques

Two other techniques, site grading and landscaping, can also be used. Site grading can be effective as a flood protection method for existing homes if the predicted flooding is relatively shallow and the runoff from the property can be handled by existing stormwater facilities. Site grading or standard landscaping designs should be considered for the sheet flow zone of alluvial fans (< 1 foot in depth). Flood flows may be dispersed with landscaping that splits the flow with wedged flow barriers or through vegetated areas. Landscaped low mounds may be oriented to divert flows to an on-site drainage path or off-site flow conveyance area. Landscaping may not be compatible with flows having high sediment loads.

### D.4.7 Relevant Equations for Computation

Equations for the computation of sediment-water mixtures, hydrodynamic forces, freeboard, and factor of safety recommendations are provided below.

**Bulking Factor:** The design flood conditions must be evaluated considering the increased flood discharge related to sediment bulking. For semi-arid alluvial fans, typical bulking factors range from 1.1 to 1.2 for sediment concentrations of 0.10 to 0.15 by volume. Bulking factors for mud flows can be as high as 2.0 ( $C_v = 0.50$ ). The bulking factor, BF, is given by Equation D-1.



**NOTE**

Concentration of Sediment ( $C_v$ ) values are estimated by engineers experienced with this type of analysis and typically range from 0 to 50 percent (decimal equivalent).



**EQUATION D-1: BULKING FACTOR**

$$BF = \frac{1.0}{1.0 - C_v} \quad (\text{Eq. D-1})$$

where:

$BF$  = dimensionless factor applied to riverine discharge values ( $Q$ ) to account for sediment bulking

$C_v$  = concentration of sediment of the fluid mixture by percent (decimal equivalent) of volume

**Hydrostatic and Hydrodynamic Loads:** Hydrostatic loading is the force of the weight of standing water acting in a perpendicular manner on a submerged surface. Sediment suspended in floodwater will increase the specific weight of the fluid as a function of sediment concentration by volume ( $C_v$ ). Water with a high sediment concentration will impose greater hydrostatic pressures than clear water. Likewise, hydrodynamic loading is related to the density of the fluid, which will increase with sediment loading. The greater mass the fluid has, the more momentum it will transfer when it impinges on an obstacle. To include the effects of sediment loading in hydrostatic and hydrodynamic calculations, the specific weight of water is replaced with the specific weight of the water-sediment mixture (Equation D-2).



**WARNING**

In hyperconcentrated sediment flows, where the sediment concentrations range from 20 to 45 percent sediment by volume, the hydrostatic pressures can be 30 to 75 percent greater than from clear water.



**NOTE**

In alluvial fan situations, hydrostatic and hydrodynamic forces developed using Equations 4-4 through 4-10 should be re-computed replacing the specific weight of water ( $\gamma$ ) with the specific weight of the water-sediment mixture ( $\gamma_s$ ).



### EQUATION D-2: SPECIFIC WEIGHT OF WATER-SEDIMENT MIXTURE

$$\gamma_s = (1 - C_v)\gamma_w + C_v S_p \gamma_w \quad (\text{Eq. D-2})$$

where:

- $\gamma_s$  = specific weight of the water-sediment mixture (lb/ft<sup>3</sup>)
- $C_v$  = sediment concentration by volume expressed as a percent (decimal equivalent)
- $\gamma_w$  = specific weight of water (62.4 lb/ft<sup>3</sup> for fresh water and 64.0 lb/ft<sup>3</sup> for salt water)
- $S_p$  = specific gravity of sediment (dimensionless)

The additional live load attributed to sediment should be considered in all calculations of hydrostatic loading with volumetric concentration of 5 percent or greater. This additional hydrostatic load will be most significant near the fan apex where sediment concentrations are higher and will decrease in the downfan direction. The loading factor related to sediment will be negligible in the sheet flow zone.

**Freeboard:** Freeboard is the additional design height of walls, levees, and foundations above the base flood level to account for velocity head, waves, splashes, and surges. The conditions of superelevation and flow runoff can be severe for mud, debris, and high velocity flows and should be evaluated separately. The U.S. Army Corps of Engineers (draft report, undated) recommends that the amount of freeboard be based on the velocity head plus the increase in depth caused by a 50 percent increase in flow rate, with a minimum value of 2 feet in alluvial fan situations, expressed by the equation shown in Equation D-3:



### EQUATION D-3: RECOMMENDED FREEBOARD

$$f = (d_{1.5Q_{design}} - d_{Q_{design}}) + \frac{V^2}{2g} \quad (\text{Eq. D-3})$$

where:

- $f$  = recommended freeboard (ft)
- $V$  = velocity of flow (ft/sec)
- $g$  = acceleration of gravity (32.2 ft/sec<sup>2</sup>)
- $d_{1.5Q_{design}}$  = depth of flooding from a discharge 50 percent greater than the design discharge (ft)
- $d_{Q_{design}}$  = depth of flooding from the design discharge (ft)

**Factors of Safety:** A factor of safety greater than 1 is an additional measure of safety to account for unanticipated or unquantifiable factors. In the case of retrofitting on alluvial fans, additional safety should be built into the design, depending on the engineer’s perception of the sensitivity of the flow conditions to change. The engineer must also weigh the cost of obsolescence if a retrofitting technique becomes inadequate with continued development. Factors of safety are always a compromise between the desire for added protection and the additional costs associated with retrofitting design and construction. Freeboard and factor of safety recommendations are provided in Table D-1.

Table D-1: Freeboard and Factor of Safety Recommendations

Freeboard and Factor of Safety Recommendations		
Type of Flooding	Freeboard (ft)	Factor of Safety
Shallow water flooding, <1 ft (FIRM Zones A and B)	1	1.10
Moderate water flooding, < 3 ft	1	1.20
Moderate water flooding, < 3 ft with potential for debris, rocks < 1 ft diameter sediment	1	1.20
Mud floods, debris flooding < 3 ft, minor surging and deposition, < 1 ft boulders	2	1.25
Mud flows, debris flows < 3 ft, surging, mud levees, > 1 ft boulders, minor waves, deposition	2	1.40
Mud and debris flows > 3 ft, surging, waves, boulders > 3 ft, major deposition	3	1.50

SOURCE: COLORADO WATER CONSERVATION BOARD, 1986

## D.5 References

Colorado Water Conservation Board. 1986. *Colorado Floodproofing Manual*.

Federal Emergency Management Agency (FEMA). 1989. *Alluvial Fans: Hazards and Management*. FEMA 165. <http://www.fema.gov/library/viewRecord.do?fromSearch=fromsearch&id=1633>.

Washington State Department of Ecology. 2007. *Living with the River*.

## APPENDIX E

# References

- AA (Aluminum Association). 1959. *Aluminum Construction Manual*.
- AA. 2010. *Aluminum Design Manual*.
- ACI (American Concrete Institute). 2008a. *Building Code Requirements for Structural Concrete and Commentary*. ACI 318-08.
- ACI. 2008b. *Building Code Requirements for Masonry Structures*. ACI 530-08.
- AISC (American Institute of Steel Construction). 2005. *Steel Construction Manual*. AISC 325-05.
- ANSI (Approved American National Standard)/AF&PA (American Forest & Paper Association). 2005. *National Design Specification for Wood Construction*. ANSI/AF&PA NDS-2005.
- APA (The Engineered Wood Association). 1997. *Plywood Design Specification*.
- APA. 1999. *Shear Transfer at Engineered Wood Floors*. Form Y250. September.
- APA. 2006. *Roof Sheathing Fastening Schedules for Wind Uplift*. Form T325. 2006.
- APA. 2007. *Diaphragms and Shear Walls*. Form L350. October.
- APA. 2011. *Design for Combined Shear and Uplift from Wind*. SR-1013. 2011.
- ASCE (American Society of Civil Engineers). 2005. *Flood Resistant Design and Construction*. ASCE Standard 24-05
- ASCE. 2006. *Seismic Rehabilitation of Existing Buildings*. ASCE/SEI Standard 41-06.
- ASCE. 2010. *Minimum Design Loads for Buildings and Other Structures*. ASCE/SEI Standard 7-10.
- ASTM International. 2007. *Standard Test Methods for Laboratory Compaction Characteristics of Soil Using Standard Effort (12 400 ft-lbf/ft<sup>3</sup> (600 kN-m/m<sup>3</sup>))*. Designation D698-07e1.
- ASTM International. 2010. *Standard Practice for Classification of Soils for Engineering Purposes (Unified Soil Classification System)*. Designation D2487-10.
- Budynas, RG; Roark, RJ; Young, WC. 1989. *Roark's Formulas for Stress and Strain*. McGraw-Hill.

- FEMA. 1987. *Reducing Losses in High Risk Flood Areas – A Guidebook for Local Officials*. FEMA 116. <http://www.fema.gov/library/viewRecord.do?fromSearch=fromsearch&id=1508>
- FEMA. 1992. *Building Performance Assessment: Hurricane Andrew in Florida*. FIA-22. <http://www.fema.gov/library/viewRecord.do?fromSearch=fromsearch&id=2765>
- FEMA. 1993a. *Non-Residential Floodproofing Requirements and Certification for Buildings Located in Special Flood Hazard Areas in Accordance with the NFIP*. NFIP Technical Bulletin 3-93. <http://www.fema.gov/library/viewRecord.do?id=1716>
- FEMA. 1993b. *Wet Floodproofing Requirements for Structures Located in Special Flood Hazard Areas in Accordance with the NFIP*. NFIP Technical Bulletin 7-93. <http://www.fema.gov/library/viewRecord.do?id=1720>
- FEMA. 1993d. *Technical Information on Elevating Substantially Damaged Residential Buildings in the Midwest*. August 24.
- FEMA. 1994. *Typical Costs for Seismic Rehabilitation of Existing Buildings*. FEMA 156. <http://www.fema.gov/library/viewRecord.do?fromSearch=fromsearch&id=1630>
- FEMA. 1999a. *Protecting Building Utilities from Flood Damage: Principles and Practices for the Design and Construction of Flood Resistant Building Utility Systems*. FEMA P-348. <http://www.fema.gov/library/viewRecord.do?fromSearch=fromsearch&id=1750>
- FEMA. 1999b. *Riverine Erosion Hazard Areas Mapping Feasibility Study*. September. <http://www.fema.gov/library/viewRecord.do?id=2209>
- FEMA. 2000a. *Above the Flood: Elevating your Floodprone House*. FEMA 347. <http://www.fema.gov/library/viewRecord.do?fromSearch=fromsearch&id=1424>
- FEMA. 2000b. *Prestandard and Commentary for the Seismic Rehabilitation of Buildings*. FEMA 356. <http://www.fema.gov/library/viewRecord.do?fromSearch=fromsearch&id=1427>
- FEMA. 2003. *Guidance for Wave Elevation Determination and V Zone Mapping*. April. <http://www.fema.gov/library/viewRecord.do?id=2357>
- FEMA. 2005a. *Guidance for Pacific Coast of the United States*. February.
- FEMA. 2005b. *Earthquake Safety Guide for Homeowners*. FEMA 530. <http://www.fema.gov/library/viewRecord.do?fromSearch=fromsearch&id=1449>
- FEMA. 2006a. *Homebuilders' Guide to Earthquake-Resistant Design and Construction*. FEMA 232. <http://www.fema.gov/library/viewRecord.do?fromSearch=fromsearch&id=2103>
- FEMA. 2006b. *National Flood Insurance Program Community Rating System, Special Hazards Supplement to the CRS Coordinator's Manual*. <http://training.fema.gov/EMIWeb/CRS/2006%20Special%20Hazards%20Supplement.pdf>
- FEMA. 2007. *Guidance for Atlantic and Gulf Coasts of the United States*. February.



- FEMA. 2008a. *Flood Damage-Resistant Materials Requirements for Buildings Located in Special Flood Hazard Areas in accordance with the National Flood Insurance Program*. NFIP Technical Bulletin 2-08. <http://www.fema.gov/library/viewRecord.do?id=1580>
- FEMA. 2008b. *Openings in Foundation Walls and Walls of Enclosures*. NFIP Technical Bulletin 1-08. <http://www.fema.gov/library/viewRecord.do?id=1579>
- FEMA. 2008c. *Free-of-Obstruction Requirements*. NFIP Technical Bulletin 5-08. <http://www.fema.gov/library/viewRecord.do?id=1718>
- FEMA. 2009a. *Homeowner's Guide to Retrofitting*. Second Edition. FEMA P-312. <http://www.fema.gov/library/viewRecord.do?fromSearch=fromsearch&id=1420>
- FEMA. 2009b. *Local Officials Guide to Coastal Construction*. FEMA P-762. <http://www.fema.gov/library/viewRecord.do?fromSearch=fromsearch&id=3647>
- FEMA. 2009c. *Recommended Residential Construction for Coastal Areas: Building on Strong and Safe Foundations*. FEMA P-550. <http://www.fema.gov/library/viewRecord.do?fromSearch=fromsearch&id=1853>
- FEMA. 2010a. *Home Builder's Guide to Coastal Construction*. FEMA P-499. <http://www.fema.gov/library/viewRecord.do?fromSearch=fromsearch&id=2138>
- FEMA. 2010b. *Wind Retrofit Guide for Residential Buildings*. FEMA P-804. <http://www.fema.gov/library/viewRecord.do?fromSearch=fromsearch&id=4569>
- FEMA. 2010c. *Substantial Improvement/Substantial Damage Desk Reference*. FEMA P-758. <http://www.fema.gov/library/viewRecord.do?fromSearch=fromsearch&id=4160>
- FEMA 2010d. *Substantial Damage Estimator*. FEMA P-784. <http://www.fema.gov/library/viewRecord.do?fromSearch=fromsearch&id=4166>
- FEMA. 2011. *Coastal Construction Manual: Principles and Practices of Planning, Siting, Designing, Construction, and Maintaining Residential Buildings in Coastal Areas (4th ed.)*. FEMA P-55. June. <http://www.fema.gov/library/viewRecord.do?fromSearch=fromsearch&id=1671>
- ICC (International Code Council). 2011a. *International Building Code*. 2012 IBC. ICC: Country Club Hills, IL.
- ICC. 2011b. *International Residential Code for One- and Two-Family Dwellings*. 2012 IRC. ICC: Country Club Hills, IL.
- ISO (Insurance Service Office, Inc.). 2011. *Building Code Effective Grading Schedule*. Accessed June 28, 2011. <http://www.isomitigation.com/bcegs/0000/bcegs0001.html>. Accessed June 28, 2011.
- NFPA (National Fire Protection Association). 2009. *Building Construction Safety Code*. NFPA 5000.
- National Oceanic and Atmospheric Administration (NOAA). *Current NWS Precipitation Frequency (PF) Documents and Related Studies*. <http://www.nws.noaa.gov/oh/hdsc/currentpf.htm>. Last accessed November 1, 2011.



Portland Cement Association. 2008. *Concrete Floors on Ground*. January.

USACE (United States Army Corps of Engineers). 1984. *Shore Protection Manual: Volume II*. Coastal Engineering Research Center. Volume two of two.

USACE. 1988. *Flood Proofing Tests – Tests of Materials and Systems for Flood Proofing Structures*. August.

USACE. 2000. *Engineering Design – Design and Construction of Levees*. EM 1110-2-1913.

United States Department of Housing and Urban Development (HUD). 1993. *Proposed Model Land Development Standards and Accompanying State Enabling Legislation*. ACCN-6212.

## APPENDIX F

# Other Resources

## Links to FEMA Hazard Mitigation Assistance (HMA) Funding Programs

HMA Overview	<a href="http://www.fema.gov/government/grant/hma/index.shtm">http://www.fema.gov/government/grant/hma/index.shtm</a>
HMA Helpline	Telephone: 866-222-3580 E-mail: <a href="mailto:hmagrantshelpline@dhs.gov">hmagrantshelpline@dhs.gov</a>
HMA Policies	<a href="http://www.fema.gov/government/grant/hma/policy.shtm">http://www.fema.gov/government/grant/hma/policy.shtm</a>
Hazard Mitigation Grant Program (HMGP)	<a href="http://www.fema.gov/government/grant/hmgrp/index.shtm">http://www.fema.gov/government/grant/hmgrp/index.shtm</a>
Pre-Disaster Mitigation (PDM)	<a href="http://www.fema.gov/government/grant/pdm/index.shtm">http://www.fema.gov/government/grant/pdm/index.shtm</a>
Flood Mitigation Assistance (FMA)	<a href="http://www.fema.gov/government/grant/fma/index.shtm">http://www.fema.gov/government/grant/fma/index.shtm</a>
Repetitive Flood Claims (RFC)	<a href="http://www.fema.gov/government/grant/rfc/index.shtm">http://www.fema.gov/government/grant/rfc/index.shtm</a>
Severe Repetitive Loss (SRL)	<a href="http://www.fema.gov/government/grant/srl/index.shtm">http://www.fema.gov/government/grant/srl/index.shtm</a>
Increased Cost of Compliance	<a href="http://www.fema.gov/plan/prevent/floodplain/ICC.shtm">http://www.fema.gov/plan/prevent/floodplain/ICC.shtm</a>
Benefit-Cost Analysis (BCA)	<a href="http://www.fema.gov/government/grant/bca.shtm">http://www.fema.gov/government/grant/bca.shtm</a>
BCA Helpline	<a href="http://www.bcahelpline.com">http://www.bcahelpline.com</a>
Environmental Planning and Historic Preservation	<a href="http://www.fema.gov/plan/ehp/index.shtm">http://www.fema.gov/plan/ehp/index.shtm</a>

## Links to FEMA Building Science Publications and Resources

Library	<a href="http://www.fema.gov/library/index.jsp">http://www.fema.gov/library/index.jsp</a>
Building Science Branch	<a href="http://www.fema.gov/rebuild/buildingscience">http://www.fema.gov/rebuild/buildingscience</a>
Catalog of FEMA Flood and Wind Publications, and Training Courses (FEMA P-787)	<a href="http://www.fema.gov/library/viewRecord.do?id=3184">http://www.fema.gov/library/viewRecord.do?id=3184</a>
Mitigation Assessment Team Reports	<a href="http://www.fema.gov/rebuild/mat/mat_reprts.shtm">http://www.fema.gov/rebuild/mat/mat_reprts.shtm</a>
National Flood Insurance Program (NFIP) Technical Bulletins	<a href="http://www.fema.gov/plan/prevent/floodplain/techbul.shtm">http://www.fema.gov/plan/prevent/floodplain/techbul.shtm</a>
Flood Insurance Program	<a href="http://www.fema.gov/business/nfip/index.shtm">http://www.fema.gov/business/nfip/index.shtm</a>
Information and Guidance on Building Safer	<a href="http://www.fema.gov/rebuild/recover/build_safer.shtm">http://www.fema.gov/rebuild/recover/build_safer.shtm</a>
Flood Insurance Studies	<a href="http://www.fema.gov/hazard/map/fis.shtm">http://www.fema.gov/hazard/map/fis.shtm</a>
Flood Insurance Rate Maps	<a href="http://www.fema.gov/hazard/map/firm.shtm">http://www.fema.gov/hazard/map/firm.shtm</a>
Map Service Center	<a href="http://msc.fema.gov">http://msc.fema.gov</a>
Mitigation	<a href="http://www.fema.gov/government/mitigation.shtm">http://www.fema.gov/government/mitigation.shtm</a>

<b>Links to FEMA Building Science Publications and Resources</b>		(concluded)
Community Rating System (CRS)	<a href="http://www.fema.gov/business/nfip/crs.shtm">http://www.fema.gov/business/nfip/crs.shtm</a>	
National Preparedness Directorate National Training and Education	<a href="http://www.training.fema.gov">http://www.training.fema.gov</a>	
CRS Resource Center	<a href="http://training.fema.gov/EMIWeb/CRS">http://training.fema.gov/EMIWeb/CRS</a>	
Alluvial Fans	<a href="http://www.fema.gov/plan/prevent/floodplain/nfipkeywords/alluvial_fan_flooding.shtm">http://www.fema.gov/plan/prevent/floodplain/nfipkeywords/alluvial_fan_flooding.shtm</a>	

<b>Building Codes and Standards</b>	
American Society of Civil Engineers Publications	<a href="http://www.pubs.asce.org">http://www.pubs.asce.org</a>
International Code Council: Codes and Standards	<a href="http://www.iccsafe.org/cs">http://www.iccsafe.org/cs</a>
National Fire Protection Association	<a href="http://www.nfpa.org/categoryList.asp?categoryID=124&amp;URL=Codes%20&amp;%20Standards">http://www.nfpa.org/categoryList.asp?categoryID=124&amp;URL=Codes%20&amp;%20Standards</a>
American Concrete Institute	<a href="http://www.concrete.org">http://www.concrete.org</a>
American Institute of Steel Construction	<a href="http://www.aisc.org">http://www.aisc.org</a>
The Aluminum Association	<a href="http://www.aluminum.org">http://www.aluminum.org</a>
The Engineered Wood Association	<a href="http://www.apawood.org">http://www.apawood.org</a>
American Society for Testing and Materials	<a href="http://www.astm.org">http://www.astm.org</a>

<b>Links to Other Resources</b>	
Natural Resource Conservation Service (NRCS)	<a href="http://www.nrcs.usda.gov/programs">http://www.nrcs.usda.gov/programs</a>
The National Oceanic and Atmospheric Administration's (NOAA's) National Weather Service (NWS)	<a href="http://www.nws.noaa.gov">http://www.nws.noaa.gov</a>
U.S. Army Corps of Engineers (USACE) Library	<a href="http://140.194.76.129/publications">http://140.194.76.129/publications</a>
NRCS Technical Resource Library	<a href="http://www.nrcs.usda.gov/technical">http://www.nrcs.usda.gov/technical</a>
NRCS Soils Website	<a href="http://soils.usda.gov">http://soils.usda.gov</a>
NWS Precipitation Frequency Studies	<a href="http://www.nws.noaa.gov/oh/hdsc/currentpf.htm">http://www.nws.noaa.gov/oh/hdsc/currentpf.htm</a>
U.S. Department of Housing and Urban Development (HUD)	<a href="http://portal.hud.gov/portal/page/portal/HUD">http://portal.hud.gov/portal/page/portal/HUD</a>
International Association of Structural Movers	<a href="http://www.iasm.org">www.iasm.org</a>
Gulf Coast Community Design Studio	<a href="http://gccds.org/research/floodproofconstruction/index.html">http://gccds.org/research/floodproofconstruction/index.html</a>

<b>Links to State and Regional Contacts</b>	
FEMA	<a href="http://www.fema.gov/about/contact/regions.shtm">http://www.fema.gov/about/contact/regions.shtm</a>
NFIP	<a href="http://www.fema.gov/business/nfip/nfip_regions.shtm">http://www.fema.gov/business/nfip/nfip_regions.shtm</a>
USACE	<a href="http://www.usace.army.mil/about/pages/locations.aspx">http://www.usace.army.mil/about/pages/locations.aspx</a>
State Hazard Mitigation Officers	<a href="http://www.fema.gov/about/contact/shmo.shtm">http://www.fema.gov/about/contact/shmo.shtm</a>

## APPENDIX G

# Summary of NFIP Requirements and Best Practices

This table, updated from FEMA P-55, *Coastal Construction Manual* (FEMA, 2011), summarizes NFIP regulatory requirements for Zone V, Coastal A Zone, and Zone A, and best practices for exceeding the requirements. These requirements and recommendations are in addition to the minimum building code requirements.

Table G-1. Summary of NFIP Regulatory Requirements and Recommendations for Exceeding the Requirements

	Zone A		Coastal A Zone		Zone V	
	Recommendations and Requirements <sup>(1)</sup>	Cross-Reference <sup>(2)</sup>	Recommendations and Requirements	Cross-Reference	Recommendations and Requirements	Cross-Reference
<b>GENERAL REQUIREMENTS</b>						
<b>Siting</b>	<p><b>Recommendation:</b> Define and evaluate vulnerability to all hazards. Site building outside of SFHA or on highest and most stable part of lot.</p> <p><b>Requirement:</b> For floodways, fill is permitted only if it has been demonstrated that the fill will not result in any increase in flood levels during the base flood.</p>	<p><b>NFIP:</b> 60.3(d)(3)</p> <p><b>IRC:</b> R301.2.4, R322.1, R322.1.4.2</p> <p><b>IBC:</b> 1612.3.4, 1804.4, App. G 103.5, App. G 401.1</p> <p><b>ASCE 24:</b> 2.2</p> <p><b>FEMA P-259:</b> 3.2.3, 3.3.2, 3.5, Ch. 5R</p> <p><b>FEMA P-55:</b> 2.3.2, Ch. 4</p>	<p><b>Recommendation:</b> Follow Zone V recommendations and requirements.</p> <p><b>Requirement:</b> Buildings governed by IRC – meet Zone A requirements (unless AHJ has adopted ASCE 24 for buildings governed by IRC). Buildings governed by IBC – follow Zone V requirements.</p>	<p><b>IBC:</b> 1804.4</p> <p><b>ASCE 24:</b> 4.3</p> <p><b>FEMA P-259:</b> 3.2.3, 3.3.2, 3.5, Ch. 5R</p> <p><b>FEMA P-55:</b> 2.3.2, Ch. 4</p> <p><b>FEMA P-499:</b> 2.1, 2.2</p>	<p><b>Recommendation:</b> Define and evaluate vulnerability to all coastal hazards and site building as far landward as possible.</p> <p><b>Requirement:</b> New construction is landward of the reach of mean high tide. Manmade alterations of sand dunes and mangrove stands that increase potential flood damage are prohibited.</p>	<p><b>NFIP:</b> 60.3(e)(3), 60.3(e)(7)</p> <p><b>IRC:</b> R322.3.1</p> <p><b>IBC:</b> App. G401.2, App. G103.7</p> <p><b>ASCE 24:</b> 4.3</p> <p><b>FEMA P-259:</b> 3.2.3, 3.3.2, 3.5, Ch. 5R</p> <p><b>FEMA P-55:</b> 2.3.2, Ch. 4, 7.5.1</p> <p><b>FEMA P-499:</b> 2.1, 2.2</p>
<b>Design and Construction</b>	<p><b>Recommendation:</b> Follow ASCE 24 requirements.</p> <p><b>Requirement:</b> Building and foundation must be designed, constructed, and adequately anchored to prevent flotation, collapse, and lateral movement resulting from hydrodynamic and hydrostatic loads, including the effects of buoyancy.</p>	<p><b>NFIP:</b> 60.3(a)(3)(i)</p> <p><b>IRC:</b> R301.1, R301.2.4, R322.1.2, R322.2</p> <p><b>IBC:</b> 1603.1.7, 1604, 1605.2.2, 1605.3.1.2, 1612</p> <p><b>ASCE 7:</b> Ch. 5</p> <p><b>ASCE 24:</b> 1.5, 2.2</p> <p><b>FEMA P-259:</b> 2.1.4, 2.4, Ch. 4, Ch. 5</p> <p><b>FEMA P-55:</b> 2.3.3, 2.3.4, 5.4.1, Ch. 8, 9.1, 9.2</p> <p><b>Other:</b> FEMA P-550</p>	<p><b>Recommendation:</b> Follow Zone V recommendations and requirements.</p> <p><b>Requirement:</b> Building and foundation must be designed, constructed, and adequately anchored to prevent flotation, collapse, and lateral movement resulting from hydrodynamic and hydrostatic loads, including the effects of buoyancy.</p>	<p><b>NFIP:</b> 60.3(a)(3)(i)</p> <p><b>IRC:</b> R301.1, R301.2.4, R322.1.2, R322.2</p> <p><b>IBC:</b> 1603.1.7, 1604, 1605.2.2, 1605.3.1.2, 1612</p> <p><b>ASCE 7:</b> Ch. 5</p> <p><b>ASCE 24:</b> 1.5, Ch. 4</p> <p><b>FEMA P-259:</b> 2.4, Ch. 4, Ch. 5</p> <p><b>FEMA P-55:</b> 2.3.3, 2.3.4, 5.4.2, Ch. 8, 9.1, 9.2</p> <p><b>FEMA P-499:</b> 3.1, 3.2, 3.3, 3.4, 3.5, 4.2, 4.2, 4.3</p> <p><b>Other:</b> FEMA P-550</p>	<p><b>Recommendation:</b> Redundant and continuous load paths should be employed to transfer all loads to the ground. Designs should explicitly account for all design loads and conditions.</p> <p><b>Requirement:</b> Building and foundation must be designed, constructed, and adequately anchored to prevent flotation, collapse, and lateral movement due to simultaneous wind loads, and flood loads, including the effects of buoyancy.</p>	<p><b>NFIP:</b> 60.3(a)(3)(i), 60.3(e)(4)</p> <p><b>IRC:</b> R301.1, R301.2.4, R322.1, R322.3.3</p> <p><b>IBC:</b> 1603.1.7, 1604, 1605.2.2, 1605.3.1.2, 1612</p> <p><b>ASCE 7:</b> Ch. 5</p> <p><b>ASCE 24:</b> 1.5, Ch. 4</p> <p><b>FEMA P-259:</b> 2.4, Ch. 4, Ch. 5</p> <p><b>FEMA P-55:</b> 2.3.3, 2.3.4, 5.4.2, Ch. 8, 9.1, 9.2</p> <p><b>FEMA P-499:</b> 3.1, 3.2, 3.3, 3.4, 4.1, 4.3</p> <p><b>Other:</b> FEMA P-550</p>

Table G-1. Summary of NFIP Regulatory Requirements and Recommendations for Exceeding the Requirements (continued)

	Zone A		Coastal A Zone		Zone V	
	Recommendations and Requirements <sup>(1)</sup>	Cross-Reference <sup>(2)</sup>	Recommendations and Requirements	Cross-Reference	Recommendations and Requirements	Cross-Reference
<b>Flood Damage-Resistant Materials</b>	<p><b>Recommendation:</b> Consider use of flood damage-resistant materials above BFE.</p> <p><b>Requirement:</b> Structural and nonstructural building materials below the DFE must be flood damage-resistant.</p>	<p><b>NFIP:</b> 60.3(a)(3)(ii)  <b>IRC:</b> R322.1.8  <b>IBC:</b> 801.5, 1403.5  <b>ASCE 24:</b> Ch. 5  <b>FEMA P-259:</b> 1.3.4, 2.1.4, 5W.2  <b>FEMA P-55:</b> 5.2.3.1, 9.4  <b>FEMA P-499:</b> 1.7, 1.8  <b>Other:</b> FEMA TB-2 and TB-8</p>	<p><b>Recommendation:</b> Consider use of flood damage-resistant materials above the BFE.</p> <p><b>Requirement:</b> Structural and nonstructural building materials below the DFE must be flood damage-resistant.</p>	<p><b>NFIP:</b> 60.3(a)(3)(ii)  <b>IRC:</b> R322.1.8  <b>IBC:</b> 801.5, 1403.5  <b>ASCE 24:</b> Ch. 5  <b>FEMA P-259:</b> 1.3.4, 5W.2  <b>FEMA P-55:</b> 5.2.3.1, 9.4  <b>FEMA P-499:</b> 1.7, 1.8, 4.3  <b>Other:</b> FEMA TB-2 and TB-8</p>	<p><b>Recommendation:</b> Consider use of flood damage-resistant materials above BFE.</p> <p><b>Requirement:</b> Structural and nonstructural building materials below the DFE must be flood damage-resistant.</p>	<p><b>NFIP:</b> 60.3(a)(3)(ii)  <b>IRC:</b> R322.1.8  <b>IBC:</b> 801.5, 1403.5  <b>ASCE 24:</b> Ch. 5  <b>FEMA P-259:</b> 1.3.4, 5W.2  <b>FEMA P-55:</b> 5.2.3.1, 9.4  <b>FEMA P-499:</b> 1.7, 1.8, 4.3  <b>Other:</b> FEMA TB-2 and TB-8</p>
<b>Free of Obstructions</b>	<p><b>Recommendation:</b> If riverine flood velocities are high or large debris load is anticipated, open foundations are recommended. Obstructions include any building element, equipment, or other fixed objects that can transfer flood loads to the foundation, or that can cause floodwaters or waves to be deflected into the building.</p> <p><b>Requirement:</b> None.</p>	<p><b>FEMA P-55:</b> 10.7, 10.9</p>	<p><b>Recommendation:</b> Follow Zone V recommendation and requirement.</p> <p><b>Requirement:</b> No limitations are imposed on obstructions below elevated floors unless the design is governed by IBC/ASCE 24 (in which case the space below the lowest floor must be free of obstructions).</p>	<p><b>IBC:</b> 1612.4  <b>ASCE 24:</b> 4.5.1  <b>FEMA P-55:</b> 5.2.3.3, 7.6.1.1.6, 10.5, 10.6  <b>FEMA P-499:</b> 1.2, 3.1, 8.1  <b>Other:</b> FEMA TB-5</p>	<p><b>Recommendation:</b> Use lattice or insect screening or louvers instead of solid breakaway walls.</p> <p><b>Requirement:</b> Open Foundation required. The space below the lowest floor must be free of obstructions, or constructed with non-supporting breakaway walls, open lattice, or insect screening.</p>	<p><b>NFIP:</b> 60.3(e)(5)  <b>IRC:</b> R322.3.3  <b>IBC:</b> 1612.4  <b>ASCE 24:</b> 4.5.1  <b>FEMA P-55:</b> 5.2.3.3, 7.6.1.1.6, Table 7-3, Table 7-4, 10.5, 10.6  <b>FEMA P-499:</b> 1.2, 3.1, 8.1  <b>Other:</b> FEMA TB- 5</p>

Table G-1. Summary of NFIP Regulatory Requirements and Recommendations for Exceeding the Requirements (continued)

	Zone A		Coastal A Zone		Zone V	
	Recommendations and Requirements <sup>(1)</sup>	Cross-Reference <sup>(2)</sup>	Recommendations and Requirements	Cross-Reference	Recommendations and Requirements	Cross-Reference
<b>ELEVATION</b>						
<b>Lowest Floor Elevation<sup>(3)</sup></b>	<p><b>Recommendation:</b> See Freeboard (additional height above required lowest floor elevation).</p> <p><b>Requirement:</b> Top of floor must be at or above BFE.</p>	<p><b>NFIP:</b> 60.3(c)(2)</p> <p><b>IRC:</b> R322.2.1, R322.1.5</p> <p><b>IBC:</b> 1612.4</p> <p><b>ASCE 24:</b> 1.5.2, 2.3</p> <p><b>FEMA P-259:</b> 2.1.4, 5E</p> <p><b>FEMA P-55:</b> 5.2.3</p> <p><b>FEMA P-499:</b> 1.4</p>	<p><b>Recommendation:</b> See Freeboard (additional height above required lowest floor elevation).</p> <p><b>Requirement:</b></p> <p><b>NFIP:</b> Top of floor must be at or above BFE.</p> <p><b>IRC:</b> Same as Zone A, plus 1 foot, if the LiMWA is delineated.</p> <p><b>IBC/ASCE 24:</b> Same as Zone V.</p>	<p><b>NFIP:</b> 60.3(c)(2)</p> <p><b>IRC:</b> R322.2.1, R322.1.5</p> <p><b>IBC:</b> 1612.4</p> <p><b>ASCE 24:</b> 1.5.2, 4.4</p> <p><b>FEMA P-259:</b> 5E</p> <p><b>FEMA P-55:</b> 5.2.3</p> <p><b>FEMA P-499:</b> 1.4</p>	<p><b>Recommendation:</b> See Freeboard (additional height above required lowest floor elevation).</p> <p><b>Requirement:</b></p> <p><b>NFIP:</b> Bottom of the lowest horizontal structural member (LHSM) of the lowest floor must be at or above the BFE.</p> <p><b>IRC:</b> Elevation based on orientation of LHSM.</p> <p><b>IBC/ASCE 24:</b> Elevation based on orientation of LHSM and structure category.</p>	<p><b>NFIP:</b> 60.3(e)(4)</p> <p><b>IRC:</b> R322.3.2, R332.1.5</p> <p><b>IBC:</b> 1612.4</p> <p><b>ASCE 24:</b> 1.5.2, 4.4</p> <p><b>FEMA P-259:</b> 5E</p> <p><b>FEMA P-55:</b> 5.2.3</p> <p><b>FEMA P-499:</b> 1.4</p>
<b>Freeboard (additional height above required Lowest Floor Elevation)<sup>(3)</sup></b>	<p><b>Recommendation:</b> Elevating buildings higher than the required lowest floor elevation provides more protection against flood damage and reduces the cost of Federal flood insurance.</p> <p><b>Requirement:</b> See Lowest Floor Elevation</p>	<p><b>IBC:</b> 1612.4</p> <p><b>ASCE 24:</b> 1.5.2, 2.3,</p> <p><b>FEMA P-259:</b> 2.2</p> <p><b>FEMA P-55:</b> 2.3.3, 5.4.1, 6.2.1, 7.5.2 (text box)</p> <p><b>FEMA P-499:</b> 1.6</p> <p><b>Other:</b> NFIP Evaluation Study</p>	<p><b>Recommendation:</b> Elevating building higher than the required lowest floor elevation provides more protection against flood damage and reduces the cost of Federal flood insurance.</p> <p><b>Requirement:</b> See Lowest Floor Elevation</p>	<p><b>IRC:</b> R322.2.1</p> <p><b>IBC:</b> 1612.4</p> <p><b>ASCE 24:</b> 1.5.2, 4.4</p> <p><b>FEMA P-259:</b> 2.2</p> <p><b>FEMA P-55:</b> 2.3.3, 5.4.2, 6.2.1, 7.5.2 (text box)</p> <p><b>FEMA P-499:</b> 1.6</p> <p><b>Other:</b> NFIP Evaluation Study</p>	<p><b>Recommendation:</b> Elevate buildings higher than the required lowest floor elevation to provide more protection against flood damage and to reduce the cost of Federal flood insurance.</p> <p><b>Requirement:</b> See Lowest Floor Elevation</p>	<p><b>IRC:</b> R322.3.2</p> <p><b>IBC:</b> 1612.4</p> <p><b>ASCE 24:</b> 1.5.2, 4.4</p> <p><b>FEMA P-259:</b> 2.2</p> <p><b>FEMA P-55:</b> 2.3.3, 5.4.2, 6.2.1, 7.5.2 (text box)</p> <p><b>FEMA P-499:</b> 1.6</p> <p><b>Other:</b> NFIP Evaluation Study</p>



Table G-1. Summary of NFIP Regulatory Requirements and Recommendations for Exceeding the Requirements (continued)

	Zone A		Coastal A Zone		Zone V	
	Recommendations and Requirements <sup>(1)</sup>	Cross-Reference <sup>(2)</sup>	Recommendations and Requirements	Cross-Reference	Recommendations and Requirements	Cross-Reference
<b>FOUNDATION</b>						
<b>Open Foundation</b>	<p><b>Recommendation:</b> If riverine flood velocities are high or large debris load is anticipated, open foundations are recommended.</p> <p><b>Requirement:</b> None<sup>(4)</sup></p>	<p><b>IBC:</b> 1612.4</p> <p><b>ASCE 24:</b> 1.5.3, 2.4, 2.5</p> <p><b>FEMA P-259:</b> 1.3.1.2, 5E.1.3</p> <p><b>FEMA P-55:</b> 2.3.3, 5.2.3, 10.2, 10.3</p> <p><b>FEMA P-499:</b> 3.5</p> <p><b>Other:</b> FEMA P-550</p>	<p><b>Recommendation:</b> Follow Zone V requirement.</p> <p><b>Requirement(4):</b> Not required unless the design is governed by IBC/ASCE 24 (in which case an open foundation is required).</p>	<p><b>IBC:</b> 1612.4</p> <p><b>ASCE 24:</b> 1.5.3, 4.5</p> <p><b>FEMA P-259:</b> 1.3.1.2, 5E.1.3</p> <p><b>FEMA P-55:</b> 2.3.3, 5.2.3, 10.2, 10.3</p> <p><b>FEMA P-499:</b> 3.1, 3.2, 3.3, 3.4, 3.5</p> <p><b>Other:</b> FEMA P-550</p>	<p><b>Recommendation:</b> Follow requirement.</p> <p><b>Requirement:</b> Open foundations are required.</p>	<p><b>NFIP:</b> 60.3(e)(4)</p> <p><b>IRC:</b> R322.3.3, R401.1</p> <p><b>IBC:</b> 1612.4</p> <p><b>ASCE 24:</b> 1.5.3, 4.5</p> <p><b>FEMA P-259:</b> 1.3.1.2, 5E.1.3</p> <p><b>FEMA P-55:</b> 2.3.3, 5.2.3, 10.2, 10.3</p> <p><b>FEMA P-499:</b> 3.1, 3.2, 3.3, 3.4</p> <p><b>Other:</b> FEMA P-550</p>
<b>Solid Foundation Walls (including walls forming crawlspace, and stemwall foundations)</b>	<p><b>Recommendation:</b> If velocities are high or debris load is anticipated, open foundations are recommended in lieu of elevation on solid walls.</p> <p><b>Requirement(4):</b></p> <p><b>NFIP:</b> Solid foundation walls are required to have flood openings.</p> <p><b>IRC:</b> Wall height is limited, unless designed; walls are required to have flood openings.</p> <p><b>IBC/ASCE 24:</b> Solid foundation walls are required to have flood openings.</p>	<p><b>NFIP:</b> 60.3(c)(5)</p> <p><b>IRC:</b> R322.2.2,R322.2.3</p> <p><b>IBC:</b> 1612.4</p> <p><b>ASCE 24:</b> 2.6</p> <p><b>FEMA P-259:</b> 1.3.1.1, 5E.1.1, 5E.1.2, 5E.1.4</p> <p><b>FEMA P-55:</b> 10.2, 10.3, 10.8</p> <p><b>FEMA P-499:</b> 3.1, 3.5</p> <p><b>Other:</b> FEMA P-550, FEMA TB-1</p>	<p><b>Recommendation:</b> Use open foundations.</p> <p><b>Requirement(4):</b></p> <p><b>NFIP:</b> Solid foundation walls are required to have flood openings.</p> <p><b>IRC:</b> Wall height is limited, unless designed.</p> <p><b>IBC/ASCE 24:</b> Solid foundation walls are not permitted if design is governed by IBC/ASCE 24.</p>	<p><b>NFIP:</b> 60.3(c)(5)</p> <p><b>IRC:</b> R322.2.2,R322.2.3</p> <p><b>IBC:</b> 1612.4</p> <p><b>FEMA P-259:</b> 1.3.1.1, 5E.1.1, 5E.1.2, 5E.1.4</p> <p><b>FEMA P-55:</b> 10.2, 10.3, 10.8</p> <p><b>FEMA P-499:</b> 3.1, 3.5</p> <p><b>Other:</b> FEMA P-550, FEMA TB-1</p>	<b>Not Permitted</b>	<p><b>NFIP:</b> 60.3(e)(4)</p> <p><b>IRC:</b> R322.3.3</p> <p><b>FEMA P-259:</b> 1.3.1.1, 5E.1.1, 5E.1.2, 5E.1.4</p> <p><b>FEMA P-55:</b> 5.2.3.3, 7.6.1.1.6, 10.2, 10.3</p> <p><b>FEMA P-499:</b> 3.1, 3.5</p> <p><b>Other:</b> FEMA TB-5, FEMA P-550</p>

Table G-1. Summary of NFIP Regulatory Requirements and Recommendations for Exceeding the Requirements (continued)

	Zone A		Coastal A Zone		Zone V	
	Recommendations and Requirements <sup>(1)</sup>	Cross-Reference <sup>(2)</sup>	Recommendations and Requirements	Cross-Reference	Recommendations and Requirements	Cross-Reference
<b>Structural Fill (including slab-on-grade foundation)</b>	<p><b>Recommendation:</b> If velocities are high or debris load is anticipated, open foundations are recommended in lieu of elevation on fill.</p> <p><b>Requirement:</b> If structural fill is used, compaction is necessary to meet requirements for stability during the base flood.</p>	<p><b>NFIP:</b> 60.3(a)(3)(i)  <b>IRC:</b> R322.1.2, R506  <b>IBC:</b> 1612.4, 1804.4, App. G 401.1  <b>ASCE 24:</b> 2.4  <b>FEMA P-55:</b> 10.3.1</p>	<p><b>Recommendation:</b> Use open foundations.</p> <p><b>Requirement:</b> If structural fill is used, compaction is necessary to meet requirements for stability during the base flood.</p>	<p><b>NFIP:</b> 60.3(a)(3)(i)  <b>IRC:</b> R322.1.2, R506  <b>IBC:</b> 1612.4, 1804.4  <b>ASCE 24:</b> 4.5.4  <b>FEMA P-55:</b> 10.3.1</p>	<b>Not Permitted</b>	<p><b>NFIP:</b> 60.3(e)(6)  <b>IRC:</b> R322.3.2  <b>IBC:</b> 1612.4, 1804.4, App. G401.2  <b>ASCE 24:</b> 4.5.4  <b>FEMA P-55:</b> 5.2.3.3</p>
<b>ENCLOSURES BELOW ELEVATED BUILDINGS</b>						
<b>Use of Enclosed Areas Below Elevated Lowest Floor<sup>(5)</sup></b>	<p><b>Recommendation:</b> Avoid storage of damageable items and hazardous materials in flood-prone spaces.</p> <p><b>Requirement:</b> Enclosures are permitted only for parking of vehicles, building access, and storage.</p>	<p><b>NFIP:</b> 60.3(c)(5)  <b>IRC:</b> R322.2.2  <b>IBC:</b> 1612.4  <b>ASCE 24:</b> 2.6  <b>FEMA P-259:</b> 2.1.4  <b>FEMA P-55:</b> 5.2.3.2</p>	<p><b>Recommendation:</b> Follow Zone V recommendations and requirements.</p> <p><b>Requirement:</b> Enclosures are permitted only for parking of vehicles, building access, and storage.</p>	<p><b>NFIP:</b> 60.3(c)(5)  <b>IRC:</b> R322.2.2  <b>IBC:</b> 1612.4  <b>ASCE 24:</b> 4.6  <b>FEMA P-55:</b> 5.2.3.2  <b>FEMA P-499:</b> 8.1</p>	<p><b>Recommendation:</b> Minimize use of enclosed areas and avoid storage of damageable items and hazardous materials.</p> <p><b>Requirement:</b> Enclosures are permitted only for parking of vehicles, building access, and storage.</p>	<p><b>NFIP:</b> 60.3(e)(5)  <b>IRC:</b> R322.3.5  <b>IBC:</b> 1612.4  <b>ASCE 24:</b> 4.6  <b>FEMA P-55:</b> 5.2.3.3  <b>FEMA P-499:</b> 8.1</p>
<b>Walls of Enclosures<sup>(6)</sup></b>	<p><b>Recommendation:</b> Follow requirement.</p> <p><b>Requirement:</b> Walls of enclosures must have flood openings to allow passage of floodwaters.</p>	<p><b>NFIP:</b> 60.3(c)(5)  <b>IRC:</b> R322.2.2  <b>IBC:</b> 1612.4  <b>ASCE 24:</b> 2.6  <b>FEMA P-259:</b> 2.1.4, 5E.1.2.1  <b>FEMA P-55:</b> 2.3.5, 5.2.3.2, 7.6.1.1.5  <b>FEMA P-499:</b> 3.1, 3.5  <b>Other:</b> FEMA TB-1</p>	<p><b>Recommendation:</b> Follow Zone V recommendations and requirements.</p> <p><b>Requirement:</b> Solid foundation wall enclosures and solid breakaway wall enclosures must have flood openings.</p>	<p><b>NFIP:</b> 60.3(c)(5)  <b>IRC:</b> R322.2.2  <b>IBC:</b> 1612.4  <b>ASCE 24:</b> 4.6  <b>FEMA P-259:</b> 5E.1.2.1  <b>FEMA P-55:</b> 2.3.5, 5.2.3.2, 7.6.1.1.5  <b>FEMA P-499:</b> 3.1, 3.5, 8.1  <b>Other:</b> FEMA TB-1 and TB-9</p>	<p><b>Recommendation:</b> Enclose areas with lattice or insect screening or louvers. Use flood openings to minimize collapse of solid breakaway walls.</p> <p><b>Requirement:</b> Walls must be designed to break away under flood loads without damaging the structure or supporting foundation system.</p>	<p><b>NFIP:</b> 60.3(e)(5)  <b>IRC:</b> R322.3.4  <b>IBC:</b> 1612.4  <b>ASCE 24:</b> 4.6  <b>FEMA P-55:</b> 2.3.5, 5.2.3.2  <b>FEMA P-499:</b> 8.1  <b>Other:</b> FEMA TB-9</p>

Table G-1. Summary of NFIP Regulatory Requirements and Recommendations for Exceeding the Requirements (continued)

	Zone A		Coastal A Zone		Zone V	
	Recommendations and Requirements <sup>(1)</sup>	Cross-Reference <sup>(2)</sup>	Recommendations and Requirements	Cross-Reference	Recommendations and Requirements	Cross-Reference
<b>UTILITIES</b>						
<b>Electrical, Heating, Ventilation, Plumbing and Air Conditioning Equipment</b>	<p><b>Recommendation:</b> Locate equipment on the downstream or landward side of building, and/or behind structural element.</p> <p><b>Requirement:</b> Utilities and equipment must be located (elevated) and designed to prevent floodwaters from entering and accumulating in components during flooding.</p>	<p><b>NFIP:</b> 60.3(a)(3)(iv)</p> <p><b>IRC:</b> R322.1.6, RM1301.1.1, RM1401.5, RM1601.4.9, RM1701.2, RM2001.4, RM2201.6, RG2404.7, RP2601.3, RP2602.2, RP2705.1, RP2101.5</p> <p><b>IBC:</b> 1403.5, 1612.4</p> <p><b>ASCE 24:</b> Ch. 7</p> <p><b>FEMA P-259:</b> 2.1.4, 5.1.5, Ch. 5W</p> <p><b>FEMA P-55:</b> Ch. 12</p> <p><b>FEMA P-499:</b> 8.3</p> <p><b>Other:</b> FEMA P-348</p>	<p><b>Recommendation:</b> Follow Zone V recommendations and requirements.</p> <p><b>Requirement:</b> Utilities and equipment must be located (elevated) and designed to prevent floodwaters from entering and accumulating in components during flooding.</p>	<p><b>NFIP:</b> 60.3(a)(3)(iv)</p> <p><b>IRC:</b> R322.1.6, RM1301.1.1, RM1401.5, RM1601.4.9, RM1701.2, RM2001.4, RM2201.6, RG2404.7, RP2601.3, RP2602.2, RP2705.1, RP2101.5</p> <p><b>IBC:</b> 1403.5, 1612.4</p> <p><b>ASCE 24:</b> Ch. 7</p> <p><b>FEMA P-259:</b> 5.1.5, Ch. 5W</p> <p><b>FEMA P-55:</b> Ch. 12</p> <p><b>FEMA P-499:</b> 8.3</p> <p><b>Other:</b> FEMA P-348, FEMA TB-5</p>	<p><b>Recommendation:</b> Locate equipment on the landward side of building, and/or behind structural element.</p> <p><b>Requirement:</b> Utilities and equipment must be located (elevated) and designed to prevent floodwaters from entering and accumulating in components during flooding.</p>	<p><b>NFIP:</b> 60.3(a)(3)(iv)</p> <p><b>IRC:</b> R322.1.6, RM1301.1.1, RM1401.5, RM1601.4.9, RM1701.2, RM2001.4, RM2201.6, RG2404.7, RP2601.3, RP2602.2, RP2705.1, RP2101.5</p> <p><b>IBC:</b> 1403.5, 1403.6, 1612.4</p> <p><b>ASCE 24:</b> Ch. 7</p> <p><b>FEMA P-259:</b> 5.1.5, Ch. 5W</p> <p><b>FEMA P-55:</b> Ch. 12</p> <p><b>FEMA P-499:</b> 8.3</p> <p><b>Other:</b> FEMA P-348, FEMA TB-5</p>
<b>Water Supply and Sanitary Sewerage Systems</b>	<p><b>Recommendation:</b> Follow requirement.</p> <p><b>Requirement:</b> Systems must be designed to minimize or eliminate infiltration of floodwaters into systems. Sanitary sewerage systems must be located to avoid impairment or contamination during flooding.</p>	<p><b>NFIP:</b> 60.3(a)(5), 60.3(a)(6)</p> <p><b>IRC:</b> R322.1.7, RP2602.2, RP3001.3</p> <p><b>IBC:</b> App. G401.3, App. G401.4, App. G701</p> <p><b>ASCE 24:</b> 7.3</p> <p><b>FEMA P-259:</b> 5.1.5, 5W.11, 5W.12</p> <p><b>FEMA P-55:</b> Ch. 12</p> <p><b>FEMA P-499:</b> 8.3</p> <p><b>Other:</b> FEMA P-348</p>	<p><b>Recommendation:</b> Follow Zone V recommendation.</p> <p><b>Requirement:</b> Systems must be designed to minimize or eliminate infiltration of floodwaters into systems. Sanitary sewerage systems must be located to avoid impairment or contamination during flooding.</p>	<p><b>NFIP:</b> 60.3(a)(5), 60.3(a)(6)</p> <p><b>IRC:</b> R322.1.7, RP2602.2, RP3001.3</p> <p><b>IBC:</b> App. G401.3, App. G401.4, App. G701</p> <p><b>ASCE 24:</b> 7.3</p> <p><b>FEMA P-259:</b> 5.1.5, 5W.11, 5W.12</p> <p><b>FEMA P-55:</b> Ch. 12</p> <p><b>FEMA P-499:</b> 8.3</p> <p><b>Other:</b> FEMA P-348, FEMA TB-5</p>	<p><b>Recommendation:</b> Install shutoff valves to isolate water and sewer lines that extend into flood-prone areas.</p> <p><b>Requirement:</b> Systems must be designed to minimize or eliminate infiltration of floodwaters into systems. Sanitary sewerage systems must be located to avoid impairment or contamination during flooding.</p>	<p><b>NFIP:</b> 60.3(a)(5), 60.3(a)(6)</p> <p><b>IRC:</b> R322.1.7, RP2602.2, RP3001.3</p> <p><b>IBC:</b> App. G401.3, App. G401.4, App. G701</p> <p><b>ASCE 24:</b> 7.3</p> <p><b>FEMA P-259:</b> 5.1.5, 5W.11, 5W.12</p> <p><b>FEMA P-55:</b> Ch. 12</p> <p><b>FEMA P-499:</b> 8.3</p> <p><b>Other:</b> FEMA P-348, FEMA TB-5</p>

Table G-1. Summary of NFIP Regulatory Requirements and Recommendations for Exceeding the Requirements (continued)

	Zone A		Coastal A Zone		Zone V	
	Recommendations and Requirements <sup>(1)</sup>	Cross-Reference <sup>(2)</sup>	Recommendations and Requirements	Cross-Reference	Recommendations and Requirements	Cross-Reference
<b>CERTIFICATION</b>						
<b>Design Certifications (foundations, breakaway walls, flood openings)</b>	<p><b>Recommendation:</b> Follow requirement.</p> <p><b>Requirement:</b> Registered design professional must certify performance of engineered flood openings (flood openings that do not conform to prescriptive requirement).</p>	<p><b>NFIP:</b> 60.3(c)(5)</p> <p><b>IRC:</b> R322.2.2(2.2)</p> <p><b>IBC:</b> 1612.5(1.2)</p> <p><b>Other:</b> FEMA TB-1</p>	<p><b>Recommendation:</b> Follow Zone V requirement.</p> <p><b>Requirement:</b> Registered design professional must certify performance of engineered flood openings (flood openings that do not conform to prescriptive requirement). If designs are governed by IBC or ASCE 24, registered design professional must certify that the design and methods of construction are in accordance with accepted standards of practice for meeting design requirements, including design of breakaway walls if designed to fail under loads more than 20 pounds per square foot.</p>	<p><b>NFIP:</b> 60.3(c)(5)</p> <p><b>IRC:</b> R322.2.2(2.2)</p> <p><b>IBC:</b> 1612.5(1.2)</p> <p><b>FEMA P-55:</b> 5.4.2</p> <p><b>FEMA P-499:</b> 1.5, 3.1, 8.1</p> <p><b>Other:</b> FEMA TB-1 and TB-9</p>	<p><b>Recommendation:</b> Follow requirement.</p> <p><b>Requirement:</b> Registered design professional must certify that the design and methods of construction are in accordance with accepted standards of practice for meeting design requirements, including design of breakaway walls if designed to fail under loads more than 20 pounds per square foot.</p>	<p><b>NFIP:</b> 60.3(e)(4), 60.3(e)(5)</p> <p><b>IRC:</b> R322.3.6</p> <p><b>IBC:</b> 1612.5(2.2) and (2.3)</p> <p><b>FEMA P-55:</b> 5.2.2.3, 5.4.2</p> <p><b>FEMA P-499:</b> 1.5, 3.1, 8.1</p> <p><b>Other:</b> FEMA TB-9</p>

Table G-1. Summary of NFIP Regulatory Requirements and Recommendations for Exceeding the Requirements (continued)

	Zone A		Coastal A Zone		Zone V	
	Recommendations and Requirements <sup>(1)</sup>	Cross-Reference <sup>(2)</sup>	Recommendations and Requirements	Cross-Reference	Recommendations and Requirements	Cross-Reference
<b>Certification of Elevation</b>	<p><b>Recommendation:</b> Surveyed elevation of the lowest floor should be submitted upon placement and prior to further vertical construction, and re-surveyed and submitted prior to the final inspection.</p> <p><b>Requirement:</b> Surveyed elevation of the lowest floor must be submitted to the community (as-built).</p>	<p><b>NFIP:</b> 60.3(b)(5)  <b>IRC:</b> R109.1.3, R322.1.10  <b>IBC:</b> 110.3.3, 1612.5(1.1)  <b>FEMA P-499:</b> 1.4, 8.3  <b>Other:</b> NFIP FMB 467-1</p>	<p><b>Recommendation:</b> Follow Zone V recommendations and requirements.</p> <p><b>Requirement:</b> Surveyed elevation of the lowest floor must be submitted to the community (as-built).</p>	<p><b>NFIP:</b> 60.3(b)(5)  <b>IRC:</b> R109.1.3, R322.1.10  <b>IBC:</b> 110.3.3, 1612.5(1.1)  <b>FEMA P-499:</b> 1.4, 8.3  <b>Other:</b> NFIP FMB 467-1</p>	<p><b>Recommendation:</b> Surveyed elevation of the bottom of the LHSM should be submitted when that member is placed and prior to further vertical construction, and re-surveyed and submitted prior to the final inspection.</p> <p><b>Requirement:</b> Surveyed elevation of the bottom of the lowest horizontal structural member must be submitted to the community (as-built).</p>	<p><b>NFIP:</b> 60.3(b)(5), 60.3(e)(2)  <b>IRC:</b> R109.1.3, R322.1.10  <b>IBC:</b> 110.3.3, 1612.5(2.1)  <b>FEMA P-499:</b> 1.4, 8.3  <b>Other:</b> NFIP FMB 467-1</p>
<b>OTHER</b>						
<b>Non-Structural Fill</b>	<p><b>Recommendation:</b> Follow requirement.</p> <p><b>Requirement<sup>(7,8)</sup>:</b> Encroachments into floodways are permitted only if it is demonstrated that the encroachment will not result in any increase in flood levels during the base flood.</p>	<p><b>NFIP:</b> 60.3(d)(3)  <b>IRC:</b> R301.2.4, R322.1, R322.1.4.2  <b>IBC:</b> 1612.3.4, 1804.4, App. G 103.5, App. G 401.1  <b>ASCE 24:</b> 2.2</p>	<p><b>Recommendation<sup>(7)</sup>:</b> Follow Zone V recommendation.</p> <p><b>Requirement:</b> None</p>		<p><b>Recommendation:</b> Minimize use of non-structural fill if flow diversion, wave runup, or reflection are concerns. Non-structural fill should be similar to existing soils where possible.</p> <p><b>Requirement:</b> Minor quantities can be used for site grading, landscaping and drainage, and to support parking slabs, patios, walkways, and pool decks. Non-structural fill must not prevent the free passage of floodwaters and waves beneath elevated buildings.</p>	<p><b>NFIP:</b> 60.3(e)(5)  <b>IRC:</b> R322.3.2  <b>ASCE 24:</b> 4.5.4  <b>FEMA P-55:</b> 5.2.3.3  <b>Other:</b> FEMA TB-5</p>

Table G-1. Summary of NFIP Regulatory Requirements and Recommendations for Exceeding the Requirements (continued)

	Zone A		Coastal A Zone		Zone V	
	Recommendations and Requirements <sup>(1)</sup>	Cross-Reference <sup>(2)</sup>	Recommendations and Requirements	Cross-Reference	Recommendations and Requirements	Cross-Reference
<b>Decks, Concrete Pads, Patios</b>	<p><b>Recommendation:</b> Follow requirement.</p> <p><b>Requirement:</b> If located below the DFE, decks, concrete pads, patios and similar appurtenances must be stable under flood loads.</p>	<p>NFIP: 60.3(a)(3)</p> <p>ASCE 24: 9.2</p> <p>FEMA P-499: 8.2</p>	<p><b>Recommendation:</b> Follow Zone V recommendations.</p> <p><b>Requirement:</b> If located below the DFE, decks, concrete pads, patios and similar appurtenances must be stable under flood loads.</p>	<p>NFIP: 60.3(a)(3)</p> <p>ASCE 24: 4.8, 9.2</p> <p>FEMA P-499: 8.2</p> <p>Other: FEMA TB-5</p>	<p><b>Recommendation:</b> Decks should be built using the same foundation as the main building, or cantilevered from the main building.</p> <p><b>Requirement:</b> If structurally attached to buildings, decks, concrete pads and patios must be elevated.</p>	<p>NFIP: 60.3(e)(3)</p> <p>IRC: R322.3.3</p> <p>ASCE 24: 4.8, 9.2</p> <p>FEMA P-55: 9.5</p> <p>FEMA P-499: 8.2</p> <p>Other: FEMA TB-5</p>
<b>Swimming Pools</b>	<p><b>Recommendation:</b> Follow requirement.</p> <p><b>Requirement:</b> Swimming pools and pool decks must be stable under flood loads.</p>	<p>NFIP: 60.3(a)(3)</p> <p>IRC: App. G101.2</p> <p>ASCE 24: 9.5</p>	<p><b>Recommendation:</b> Follow Zone V recommendation.</p> <p><b>Requirement:</b> Swimming pools and pool decks must be stable under flood loads.</p>	<p>NFIP: 60.3(a)(3)</p> <p>IRC: App. G101.2</p> <p>ASCE 24: 9.5</p> <p>FEMA P-499: 8.2</p>	<p><b>Recommendation:</b> Pool should be located as far landward as possible and should be oriented in such a way that flood forces are minimized.</p> <p><b>Requirement:</b> Swimming pools and pool decks must be stable under flood loads and elevated, designed to break away during the design flood, or be sited to remain in-ground without obstructing flow that results in damage to adjacent structures.</p>	<p>NFIP: 60.3(e)(3)</p> <p>IRC: R322.3.3, App. G101.2</p> <p>ASCE 24: 9.5</p> <p>FEMA P-55: 9.5</p> <p>FEMA P-499: 8.2</p> <p>Other: FEMA TB-5</p>

Table G-1. Summary of NFIP Regulatory Requirements and Recommendations for Exceeding the Requirements (concluded)

	Zone A		Coastal A Zone		Zone V	
	Recommendations and Requirements <sup>(1)</sup>	Cross-Reference <sup>(2)</sup>	Recommendations and Requirements	Cross-Reference	Recommendations and Requirements	Cross-Reference
<b>Tanks Associated with Building Utilities</b>	<p><b>Recommendation:</b> Locate above-ground tanks on the landward or downstream side of buildings and raise inlets, fill openings, and vents above the DFE.</p> <p><b>Requirement:</b> Tanks must be elevated or anchored to be stable under flood loads, whether above-ground or underground.</p>	<p><b>NFIP:</b> 60.3(a)(3)  <b>IRC:</b> R2201.6  <b>IBC:</b> App. G701  <b>ASCE 24:</b> 7.4.1  <b>FEMA P-259:</b> 5W.10  <b>Other:</b> FEMA P-348</p>	<p><b>Recommendation:</b> Follow Zone V recommendations.</p> <p><b>Requirement:</b> Tanks must be elevated or anchored to be stable under flood loads, whether above-ground or underground.</p>	<p><b>NFIP:</b> 60.3(a)(3)  <b>IRC:</b> R2201.6  <b>IBC:</b> App. G701  <b>ASCE 24:</b> 7.4.1  <b>FEMA P-259:</b> 5W.10  <b>FEMA P-499:</b> 8.3  <b>Other:</b> FEMA TB-5, FEMA P-348</p>	<p><b>Recommendation:</b> Locate above-ground tanks on the landward side of buildings and raise inlets, fill openings and vents above the DFE. Install underground tanks below the eroded ground elevation.</p> <p><b>Requirement:</b> Above-ground tanks must be elevated.</p>	<p><b>NFIP:</b> 60.3(e)(3)  <b>IRC:</b> R2201.6  <b>IBC:</b> App. G701  <b>ASCE 24:</b> 7.4.1  <b>FEMA P-259:</b> 5W.10  <b>FEMA P-499:</b> 8.3  <b>Other:</b> FEMA TB-5, FEMA P-348</p>
<b>Sustainable Design</b>	<p><b>Recommendation:</b> Building for natural hazards resistance reduces the need to rebuild and is a sustainable design approach. Verify that other green building practices do not reduce the building's ability to resist flood loads or other natural hazards.</p> <p><b>Requirement:</b> Meet overall NFIP performance requirements.</p>	<p><b>FEMA P-55:</b> 7.7  <b>Other:</b> FEMA P-798, ICC 700</p>	<p><b>Recommendation:</b> Building for natural hazards resistance reduces the need to rebuild and is a sustainable design approach. Verify that other green building practices do not reduce the building's ability to resist flood loads or other natural hazards.</p> <p><b>Requirement:</b> Meet overall NFIP performance requirements.</p>	<p><b>FEMA P-55:</b> 7.7  <b>Other:</b> FEMA P-798, ICC 700</p>	<p><b>Recommendation:</b> Building for natural hazards resistance reduces the need to rebuild and is a sustainable design approach. Verify that other green building practices do not reduce the building's ability to resist flood loads or other natural hazards.</p> <p><b>Requirement:</b> Meet overall NFIP performance requirements.</p>	<p><b>FEMA P-55:</b> 7.7  <b>Other:</b> FEMA P-798, ICC 700</p>



## NOTES

- (1) Individual States and communities may enforce more stringent requirements that supersede those summarized here. **Exceeding minimum NFIP requirements will provide increased flood protection and may result in lower flood insurance premiums.**
- (2) The references in this section cite the latest available publications at the time of publication of this Manual. The specific editions of these references are:
  - **ASCE 7:** ASCE 7-10, *Minimum Design Loads for Buildings and Other Structures*
  - **ASCE 24:** ASCE 24-05, *Flood Resistant Design and Construction*
  - **IBC:** *2012 International Building Code*. Appendix G includes provisions for flood-resistant construction. The provisions in IBC Appendix G are not mandatory unless specifically referenced in the adopting ordinance. Many States have not adopted Appendix G. Section references are the same as 2009 IBC.
  - **ICC 700:** *National Green Building Standard* (ICC 2008)
  - **IRC:** *2012 International Residential Code for One- and Two-Family Dwellings*. Section references are the same as 2009 IRC.
  - **FEMA P-55:** Specific sections or chapters of FEMA P-55, *Coastal Construction Manual* (2011a)
  - **FEMA P-259:** Specific sections or chapters of this Manual, FEMA P-259, *Engineering Principles and Practices for Retrofitting Flood-Prone Residential Structures* (2011b)
  - **FEMA P-348:** 1999 Edition of FEMA P-348, *Protecting Building Utilities From Flood Damage*
  - **FEMA P-499:** Specific fact sheets in the 2010 edition of FEMA P-499, *Home Builder's Guide to Coastal Construction Technical Fact Sheet Series*
  - **FEMA P-550:** *Recommended Residential Construction for Coastal Areas* (Second Edition, 2009)
  - **FEMA P-798:** *Natural Hazards and Sustainability for Residential Buildings* (2010)
  - **FEMA TB:** Specific numbered FEMA NFIP Technical Bulletins (available at <http://www.fema.gov/plan/prevent/floodplain/techbul.shtm>)
  - **NFIP:** *U.S. Code of Federal Regulations* – 44 CFR 60.3 “Flood plain management criteria for flood-prone areas.” Current as of June 30, 2011.
  - **NFIP Evaluation Study:** *Evaluation of the National Flood Insurance Program's Building Standards* (American Institutes for Research 2006)
  - **NFIP FMB 467-1:** *Floodplain Management Bulletin on the NFIP Elevation Certificate*. Note that this bulletin was published in 2004, while the Elevation Certificate (FEMA Form 81-31) has been updated since 2004, and is updated periodically.
- (3) State or community may regulate to a higher elevation (DFE).
- (4) Some coastal communities require open foundations in Zone A.
- (5) There are some differences between what is permitted under floodplain management regulations and what is covered by NFIP flood insurance. Building designers should be guided by floodplain management requirements, not by flood insurance policy provisions.
- (6) Some coastal communities prohibit breakaway walls and allow only open lattice or screening.
- (7) Placement of nonstructural fill adjacent to buildings in Zone AO in coastal areas is not recommended.
- (8) Some communities may allow encroachments to cause a 1-foot rise in the flood elevation, while others may allow no rise.

---

**ACRONYMS**

<b>ASCE</b>	American Society of Civil Engineers
<b>BFE</b>	base flood elevation
<b>DFE</b>	design flood elevation
<b>FEMA</b>	Federal Emergency Management Agency
<b>FMB</b>	Floodplain Management Bulletin
<b>IBC</b>	International Building Code
<b>ICC</b>	International Code Council
<b>IRC</b>	International Residential Code
<b>LHSM</b>	lowest horizontal structural member
<b>NFIP</b>	National Flood Insurance Program
<b>SFHA</b>	Special Flood Hazard Area
<b>TB</b>	Technical Bulletin

**REFERENCES**

- American Institutes for Research. 2006. *Evaluation of the National Flood Insurance Program's Building Standards*. October.
- ASCE (American Society of Civil Engineers). 2005. *Flood Resistant Design and Construction*. ASCE Standard ASCE 24-05.
- ASCE. 2010. *Minimum Design Loads for Buildings and Other Structures*. ASCE Standard ASCE 7-10.
- ICC (International Code Council). 2008. *National Green Building Standard, ICC 700*. Birmingham, AL.
- ICC. 2009a. *International Building Code*. Birmingham, AL.
- ICC. 2009b. *International Residential Code for One- and Two-Family Dwellings*. Birmingham, AL.
- FEMA (Federal Emergency Management Agency). 1996. *Corrosion Protection for Metal Connectors in Coastal Areas for Structures Located in Special Flood Hazard Areas in accordance with the National Flood Insurance Program*. Technical Bulletin 8-96.
- FEMA. 1999. *Protecting Building Utilities from Flood Damage*. FEMA P-348.
- FEMA. 2004. *Floodplain Management Bulletin on the Elevation Certificate*. NFIP Bulletin 467-1. May.
- FEMA. 2008a. *Design and Construction Guidance for Breakaway Walls Below Elevated Buildings Located in Coastal High Hazard Areas*. NFIP Technical Bulletin 9.

- FEMA. 2008b. *Flood Damage-Resistant Materials Requirements for Buildings Located in Special Flood Hazard Areas*. NFIP Technical Bulletin 2.
- FEMA. 2008c. *Free-of-Obstruction Requirements for Buildings Located in Coastal High Hazard Areas*. NFIP Technical Bulletin 5.
- FEMA. 2008d. *Openings in Foundation Walls and Walls of Enclosures Below Elevated Buildings in Special Flood Hazard Areas*. NFIP Technical Bulletin 1.
- FEMA. 2009b. *Recommended Residential Construction for Coastal Areas: Building on Strong and Safe Foundations*. FEMA P-550. December.
- FEMA. 2010a. *Home Builder's Guide to Coastal Construction Technical Fact Sheet Series*. FEMA P-499. December.
- FEMA. 2010b. *Natural Hazards and Sustainability for Residential Buildings*. FEMA P-798. September.
- FEMA. 2011a. *Coastal Construction Manual*. FEMA P-55, Fourth Edition.
- FEMA. 2011b. *Engineering Principles and Practices for Retrofitting Flood-Prone Residential Structures*. FEMA P-259, Third Edition.
- U.S. Code of Federal Regulations. "Flood plain management criteria for flood-prone areas." 44 CFR 60.3. June 30, 2011.

## APPENDIX H

# Acronyms

## A

<b>AC</b>	Air conditioner
<b>ACI</b>	American Concrete Institute
<b>ADA</b>	Americans with Disabilities Act
<b>AISC</b>	American Institute of Steel Construction
<b>APA</b>	American Planning Association
<b>ASC</b>	Area of Special Consideration
<b>ASCE</b>	American Society of Civil Engineers
<b>ASTM</b>	ASTM International

## B

<b>BCA</b>	benefit-cost analysis
<b>BCR</b>	benefit-cost ratio
<b>BFE</b>	base flood elevation
<b>BTU</b>	British thermal unit

## C

<b>CATV</b>	Cable TV
-------------	----------

<b>CFR</b>	Code of Federal Regulations
<b>CMU</b>	concrete masonry unit
<b>CRS</b>	Community Rating System

## D

<b>DFE</b>	design flood elevation
<b>DFIRM</b>	digital FIRMs

## F

<b>FEMA</b>	Federal Emergency Management Agency
<b>FHA</b>	Fair Housing Amendment Act
<b>FIA</b>	Federal Insurance Administration
<b>FIMA</b>	Federal Insurance and Mitigation Administration
<b>FIRM</b>	Flood Insurance Rate Map
<b>FIS</b>	Flood Insurance Study
<b>FMA</b>	Flood Mitigation Assistance
<b>FPE</b>	Flood Protection Elevation
<b>ft</b>	feet
<b>ft<sup>2</sup></b>	square feet
<b>ft<sup>3</sup></b>	cubic feet
<b>ft/sec</b>	feet per second

## G

<b>GAL</b>	Gallons
<b>GFCI</b>	ground fault circuit interrupter
<b>gph</b>	gallons per hour
<b>gpm</b>	gallons per minute

# H

<b>HMA</b>	Hazard Mitigation Assistance
<b>HMGP</b>	Hazard Mitigation Grant Program
<b>hp</b>	horsepower
<b>HR</b>	hour
<b>HUD</b>	U.S. Department of Housing and Urban Development
<b>HVAC</b>	heating, ventilation, and air conditioning

# I

<b>IASM</b>	International Association of Structural Movers
<b>IBC</b>	International Building Code
<b>ICC</b>	Increased Cost of Compliance
<b>I-Codes</b>	International Building Code Series
<b>IEBC</b>	International Existing Building Code
<b>IFC</b>	International Fire Code
<b>IFGC</b>	International Fuel Gas Code
<b>IMC</b>	International Mechanical Code
<b>in.</b>	inches
<b>in.<sup>2</sup></b>	square inches
<b>IPC</b>	International Plumbing Code
<b>IPSDC</b>	International Private Sewage Disposal Code
<b>IRC</b>	International Residential Code

# K

<b>kW</b>	kilowatts
-----------	-----------

**L**

<b>LAG</b>	lowest adjacent grade
<b>lb(s)</b>	pound(s)
<b>lb/ft<sup>2</sup></b>	pounds per square foot
<b>lf</b>	linear feet
<b>LiMWA</b>	Limit of Moderate Wave Action
<b>LPG</b>	liquefied petroleum gas

**M**

<b>MiWA</b>	Minimal Wave Action
<b>MoWA</b>	Moderate Wave Action
<b>MSC</b>	FEMA Map Service Center
<b>MW</b>	masonry wall

**N**

<b>NAVD88</b>	North American Vertical Datum of 1988
<b>NEC</b>	National Electrical Code
<b>NEMA</b>	National Electrical Manufacturers Association
<b>NES</b>	National Evaluation Service
<b>NFIP</b>	National Flood Insurance Program
<b>NFPA</b>	National Fire Protection Association
<b>NRCS</b>	Natural Resources Conservation Service
<b>NWS</b>	National Weather Service

**P**

<b>PDM</b>	Pre-Disaster Mitigation
------------	-------------------------



**PVC** polyvinylchloride

## R

**RFC** Repetitive Flood Claims

**RGS** rigid galvanized steel

**RI** recurrence interval

**rpm** revolutions per minute

## S

**sec** seconds

**sec<sup>2</sup>** seconds squared

**SFHA** Special Flood Hazard Area

**SRL** Severe Repetitive Loss

## T

**TH** total discharge head

## U

**UF** underground feeder

**UL** Underwriters Laboratories

**USACE** U.S. Army Corps of Engineers

**USCS** Unified Soil Classification System







FEMA

FEMA P-259  
Catalog No: 11334-1